

ARCHITECTURAL  
LIGHTING

TENDA  LIGHTING

TENDA LIGHTING  
TEL+86 760 22533562  
WWW.TENDALIGHTING.COM

COLLECTION 2018-2019





## TENDA architecture

Lighting is one of the material languages in architecture. TENDA dedicates itself fully to supply extremely good quality led lights, to bring people visual comfort, emotional satisfaction, vivid and impressive light feeling.

Built in 2013, TENDA is actively developing. Production is located in Zhongshan city, China. We are able to provide quick OEM and ODM solutions tailored to fit customers' specific lighting requirements for architect areas. Our technically sophisticated and aesthetically convincing LED luminaires are highly recommended and used by lighting designers.

We care about mostly, the value for people. We stand for openness, honesty and confidence. We are a light factory instead of a luminaires factory.



## QUALITY & GUARANTEE

Quality and safety have the highest priority for all TENDA products. When designing new products, we are focus on meeting the requirements for residential and architecture applications. Must be different, top-quality design, excellent functionality, the best possible product safety and a long service life.

We offer 3-5 years guarantee at least for all our products.

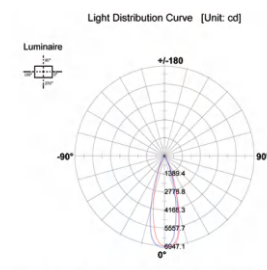



The solution for a total fusion with architecture,  
achieved thanks to the total integration of luminaries  
that can disappear inside surface.  
Its magnetic installation offers super easy way  
to design the light in space.  
Compatible with International DALI protocol.

Easy electrical collection pins.



Electrical conductor with  
24V power connection.

DALI transmission.





# SUPER CRI- PERFECT COLOR

THE CRI VALUE OF A LED IS ESTABLISHED BY THE MEAN OFFERED IN THECHROMATIC RENDERING OF A SERIES OF REFERENCE COLORS.

EVEN WHEN TESTED WITH THE COLORS THAT ARE MORE UNFAVORABLY RENDERED BY LED LIGHT SOURCES (R9,R10).

SUPER-CRI OFFERS OUTSTANDING VALUES AT ANY OF THE TEMPERATURES (2700K,3000 AND 4000K).



R9 \_ Strong red  
2700K Super Warm White  
3000K Warm White  
4000K Cool Warm White

CRI 96  
CRI 95  
CRI 92

R10 \_ Strong yellow  
2700k Super Warm White  
3000K Warm White  
4000K Cool Warm White

CRI 92  
CRI 91  
CRI 92





A photograph of a laptop with a rainbow-colored keyboard, resting on a wooden desk. The laptop is open, and the keyboard is illuminated with a spectrum of colors from blue to red. The desk is made of light-colored wood, and the background is dark.

## • TM-30-15:

- A New Method for Measuring Color Rendition Illumination Engineering Society's (IES) TM-30-15 the most recently developed method of evaluating color rendition, is garnering a lot of attention in the lighting community. TM-30-15 seeks to supplant CRI as the industry standard for measuring color rendition. We at TENDA have observed significant interest in TM-30-15 among our customers.





## WHAT IS TM-30-15?

---

TM-30-15 is a method of evaluating color rendition. It comprises three primary components:

1. Rf- a fidelity index that is similar to the commonly used CRI
2. Rg- a gamut index that provides information about saturation
3. Color vector graphic- a graphical representation of hue and saturation relative to a reference source.



## WHAT ARE THE DIFFERENCES BETWEEN TM-30-15 AND CRI?

---

- There are a few important differences. First, CRI provides information only about fidelity, i.e. the accurate rendition of color such that objects appear similar to how they would under familiar reference illuminants such as daylight and incandescent light. However, CRI doesn't provide any information on saturation. The picture below shows two images with the same CRI and different levels of saturation. While the images obviously look very different because of different saturation levels, CRI doesn't provide a mechanism of describing these differences. TM-30-15 uses the Gamut Index (Rg) to describe differences in saturation.





# INDEX

technology  
T E  
emotion  
N D A  
nature  
design  
architecture

Magnetic track system - 48V Mpower
Magnetic track system - 24V Magni
Sharp family - Immersive lighting experience
Raster linear downlight full family
Prolight - modular spotlight available in IP65 indoor
TRACK LIGHTS
UGR DOWNLIGHTS
SPOTLIGHTS
PANEL LIGHTS
PANDENT LIGHTS





# TM30

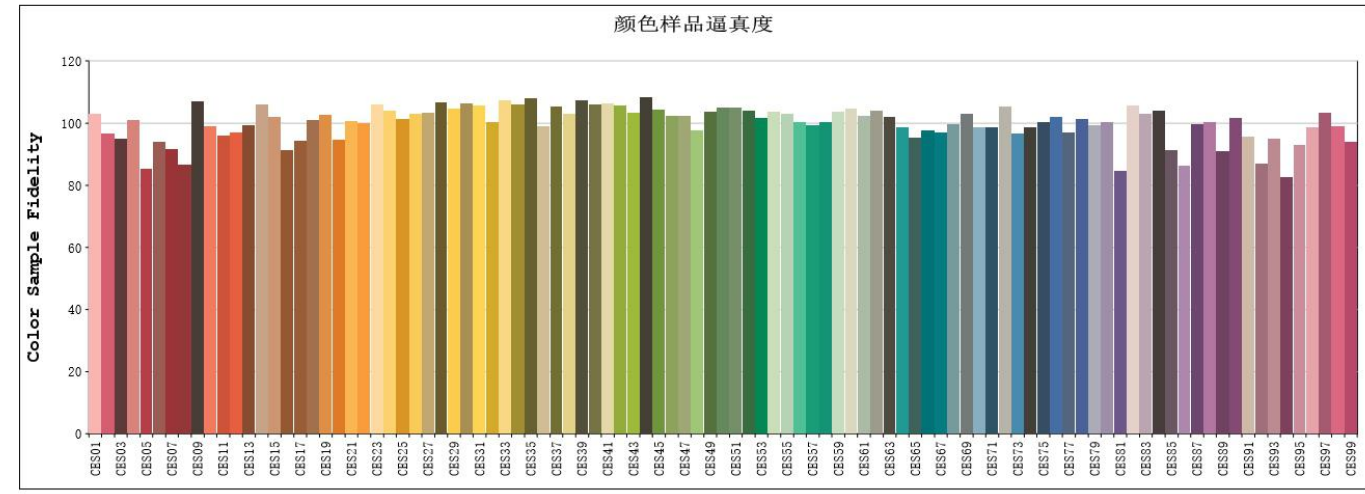
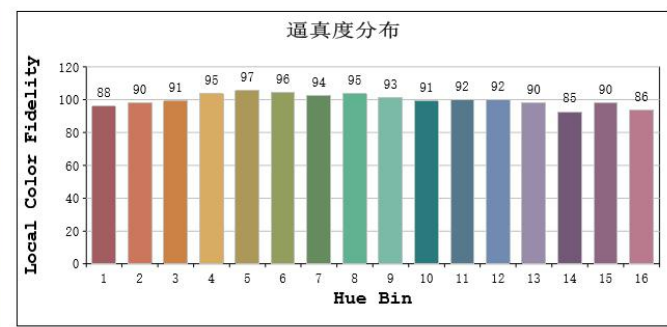
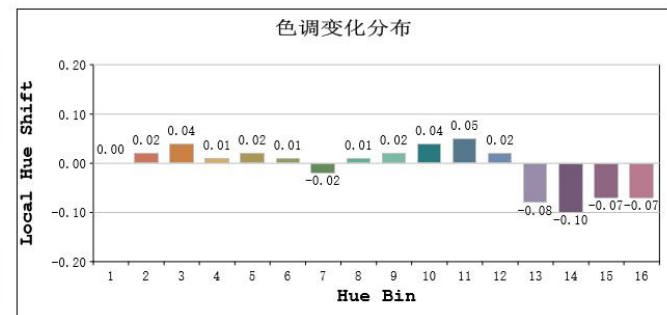
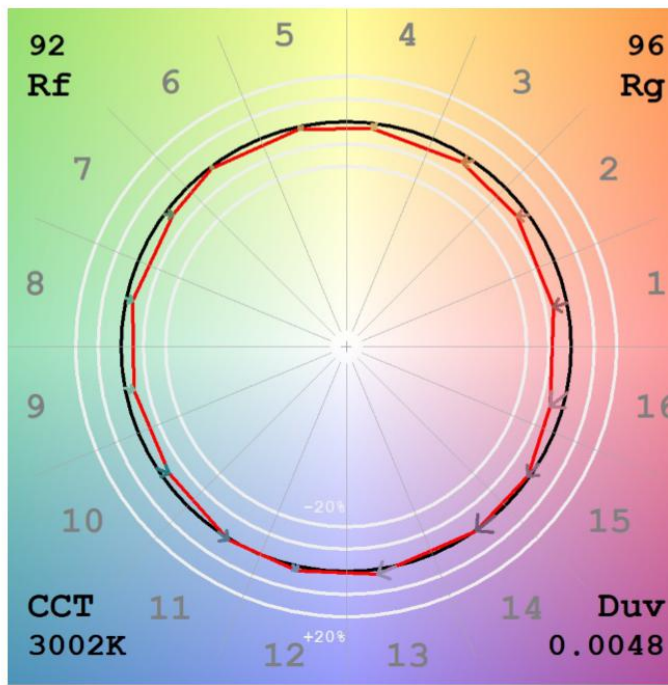
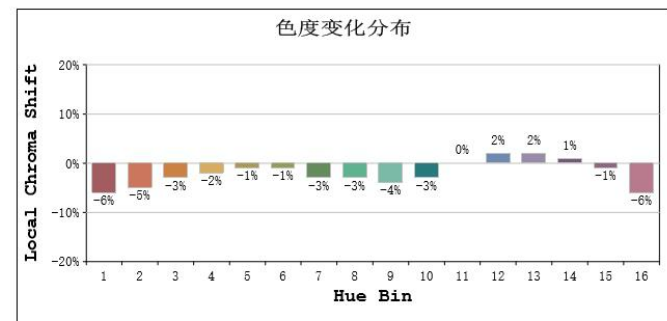
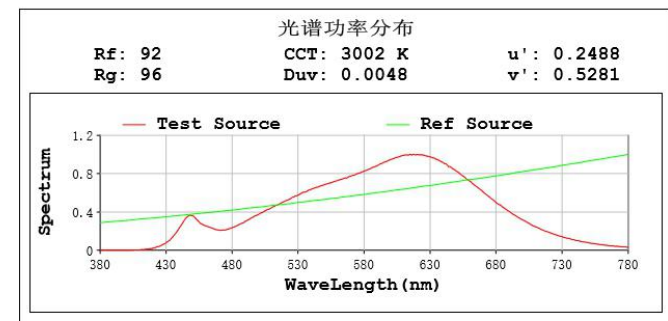

We don't try to use the chips which inflate CRI with artificial peaks that match the eight CRI color samples. Because of these broad spectra, the CRI score and Rf index in TM-30-15 are expected to be similar. Indeed, upon using the TM-30-15 method, we found that most our products have CRI and Rf scores that are very similar and differ by only 1-2 points.



# INDEX

**Mpower**

Page 1-26

**Raster**

Page 27-88

**Director X**

Page 89-90

**Magni**

Page 91-114

**Prolight**

Page 115-134

**Sharp**

Page 135-152

**Unico**

Page 153-174

**Magic**

Page 175-210

**Bath**

Page 211-214

**Out**

Page 215-218

**Slim**

Page 219-224

**Duly**

Page 225-230

**Round**

Page 231-234

**Luce**

Page 235-240

**OFI**

Page 241-248

**Dot**

Page 249-256

**Ring**

Page 257-258

**Master**

Page 259-262

**Coole**

Page 263-270

**Mini**

Page 271-274

**Clean**

Page 275-324

**Inout**

Page 325-330

**Jerry**

Page 331-342

**Drop**

Page 343-346

**Alan**

Page 347-352

**Ivy**

Page 353-366

**Stars**

Page 367-370

**Super bowl**

Page 371-380

**UGR down light**

Page 381-382

**Libra**

Page 383-384

**Coin**

Page 385-388

**AMG**

Page 389-390

**Bing**

Page 391-392

**Moon**

Page 393-404

**HIO**

Page 405-410

**Loop**

Page 411-418

**Circle**

Page 419-422

**Light white**

Page 423-424

.....



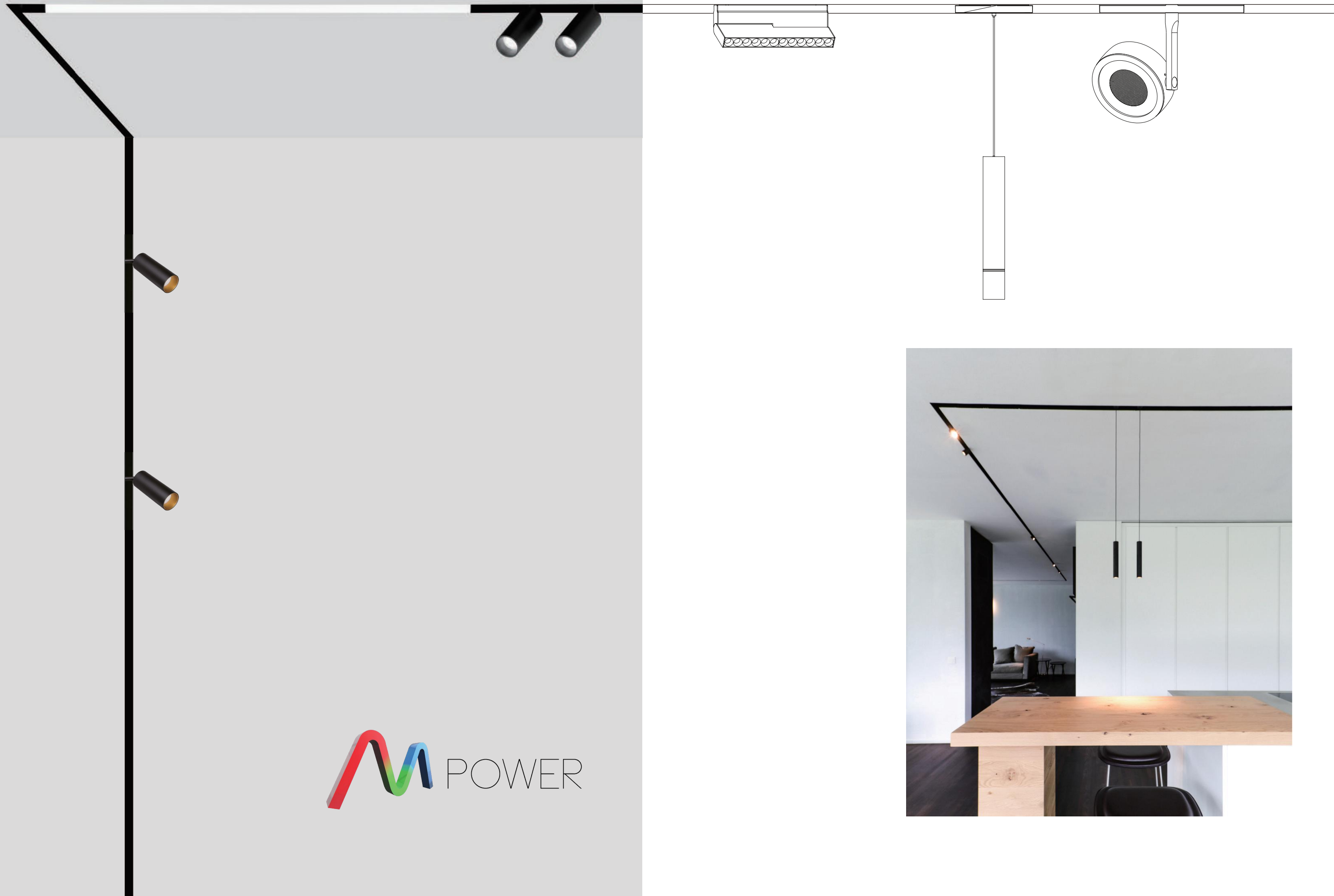

 MPOWER





JUST KEEP BREATHIN'  
START THE DAY WITH  
A SMILE  
memory

TEND 



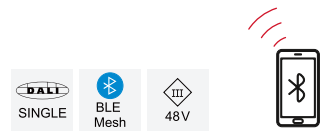

Length	Input Voltage	Installation	Material	Color	Model Number
1000mm	DC48V	surface	aluminum	black	MP-SUR-TR100B
2000mm	DC48V	surface	aluminum	black	MP-SUR-TR200B
3000mm	DC48V	surface	aluminum	black	MP-SUR-TR300B

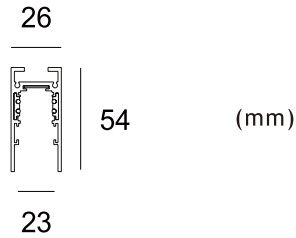

INSTALLATION TRACK

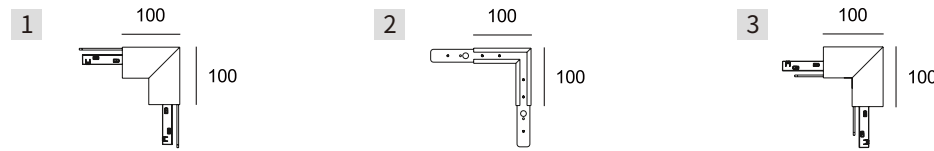

**1** MP-SUR-VER90 vertical track corner 90° surface+circuit corner connector  
**2** MP-SUR-HOR90 horizontal track corner 90° surface+circuit corner connector  
**3** MP-SUR-EXT90 external track corner 90° surface+circuit corner connector

CEILING FASTENER/CABLE SUSPENSION/CANOOPY

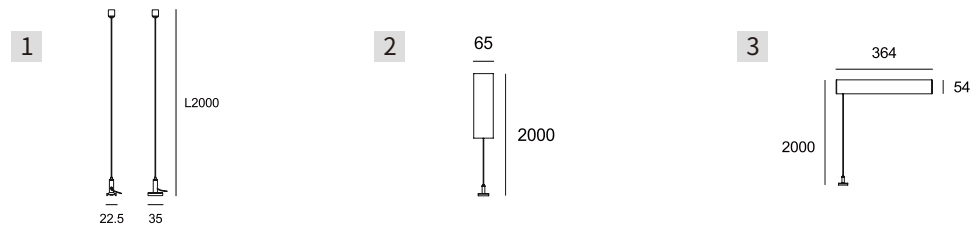

**1** MP-KIT-SUS01 suspended kit for surface track 200CM CABLE  
**2** MP-KIT-SUS02 suspended kit with driver box for surface track  
**3** MP-KIT-SUS03 suspended kit with driver box for surface track

Quickinfo

- GENERAL**  
surface, suspended  
IP20
- ELECTRICAL**  
NON DIM, DIM DALI, BLE MESH  
transparent feeder cable
- PHYSICAL**  
aluminium  
spray powder

POWER FEEDER UNIT

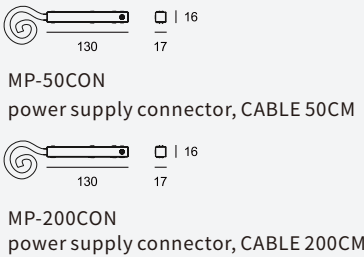

CONNECTOR SET

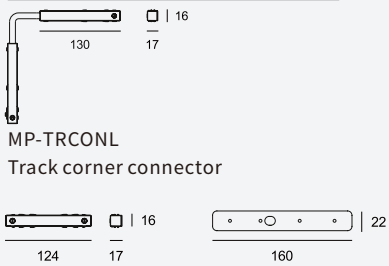

MP-TRCONL  
Track corner connector  
 MP-TRCON  
Track connector

END CAPS

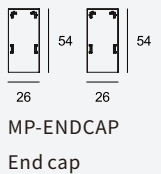

MP-ENDCAP  
End cap

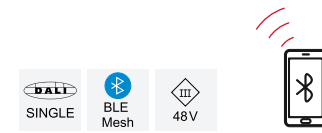

Length	Input Voltage	Installation	Material	Color	Model Number
1000mm	DC48V	trim 30mm	aluminum	black	MP-RE-100B
2000mm	DC48V	trim 30mm	aluminum	black	MP-RE-200B
3000mm	DC48V	trim 30mm	aluminum	black	MP-RE-300B

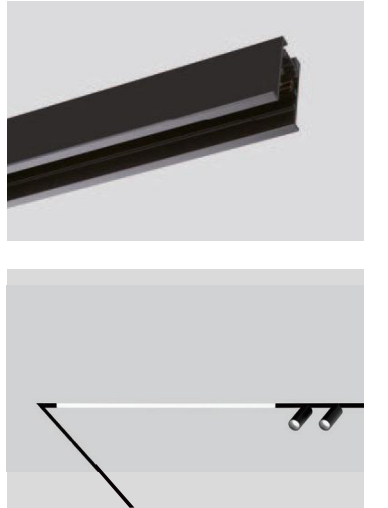
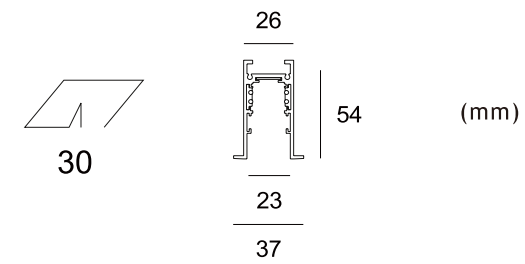

INSTALLATION TRACK

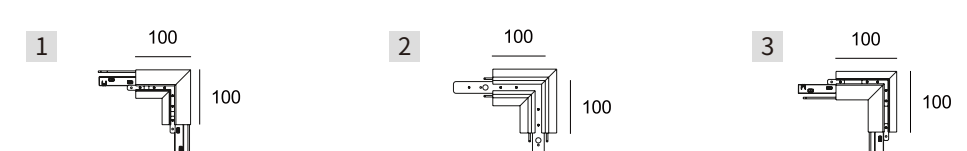

**1** MP-RETR-VER90 vertical track corner 90° trimless+circuit corner connector  
**2** MP-RETR-HOR90 horizontal track corner 90° trimless+circuit corner connector  
**3** MP-RETR-EXT90 external track corner 90° trimless+circuit corner connector

POWER FEEDER UNIT

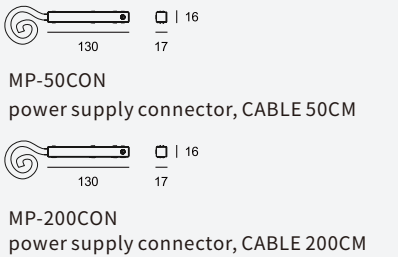

CONNECTOR SET

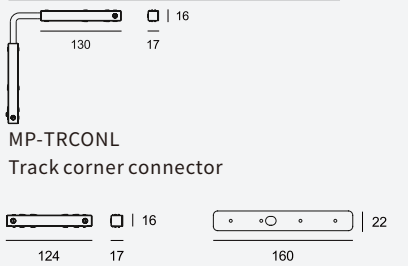

MP-TRCONL  
Track corner connector  
 MP-TRCON  
Track connector

END CAPS

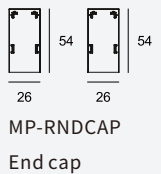

MP-RNDCAP  
End cap

Quickinfo

- GENERAL**  
recessed trim  
IP20
- ELECTRICAL**  
NON DIM, DIM DALI, BLE MESH  
transparent feeder cable
- PHYSICAL**  
aluminium  
spray powder



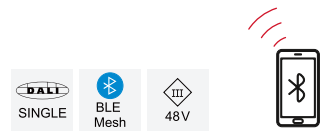

Length	Input Voltage	Installation	Material	Color	Model Number
1000mm	DC48V	trimless 30mm	aluminum	black	MP-RE02T-TR100B
2000mm	DC48V	trimless 30mm	aluminum	black	MP-RE02T-TR200B
3000mm	DC48V	trimless 30mm	aluminum	black	MP-RE02T-TR300B

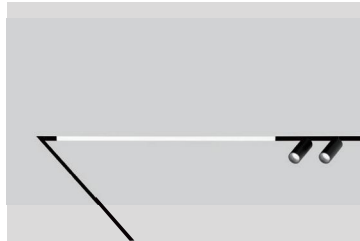
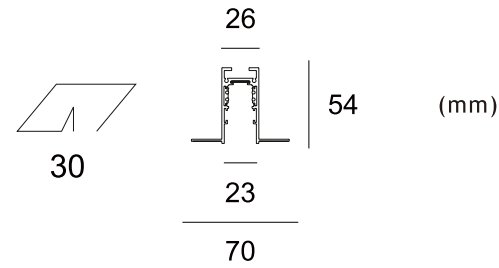

INSTALLATION TRACK

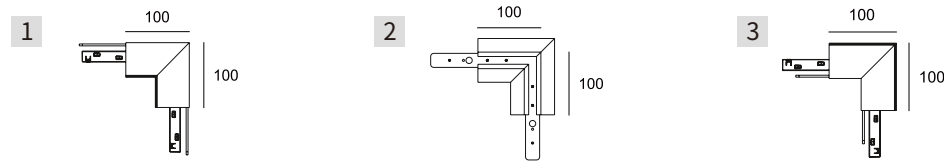

- 1. MP-RE01-VER90 vertical track corner 90° trimless+circuit corner connector
- 2. MP-RE01-HOR90 horizontal track corner 90° trimless+circuit corner connector
- 3. MP-RE01-EXT90 external track corner 90° trimless+circuit corner connector

Quickinfo

**GENERAL**  
recessed trimless  
IP20

**ELECTRICAL**  
NON DIM, DIM DALI, BLE MESH

**PHYSICAL**  
aluminium  
spray powder

POWER FEEDER UNIT

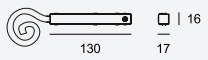

MP-50CON  
power supply connector, CABLE 50CM

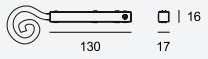

MP-200CON  
power supply connector, CABLE 200CM

CONNECTOR SET

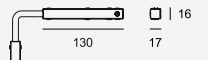

MP-TRCONL  
Track corner connector



MP-TRCON  
Track connector

END CAPS

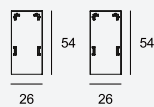

MP-ENDCAP  
End cap

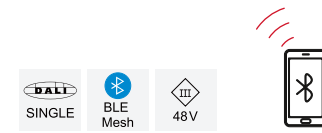

Length	Input Voltage	Installation	Material	Color	Model Number
1000mm	DC48V	trimless 40mm	aluminum	black	MP-RE01T-TR100B
2000mm	DC48V	trimless 40mm	aluminum	black	MP-RE01T-TR200B
3000mm	DC48V	trimless 40mm	aluminum	black	MP-RE01T-TR300B

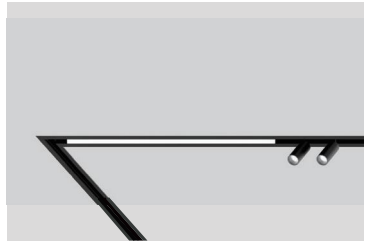
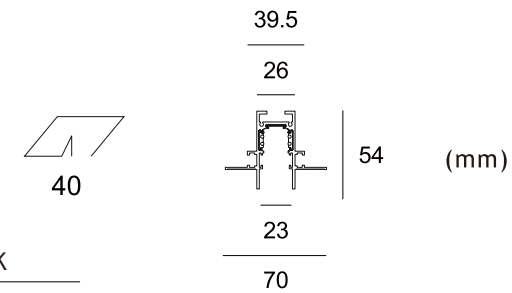

INSTALLATION TRACK

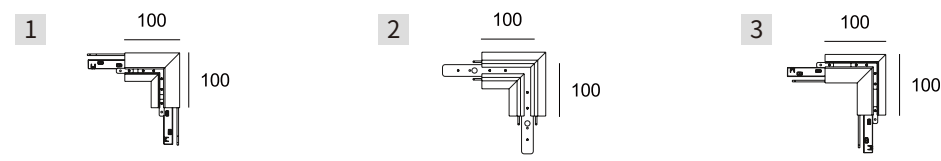

- 1. MP-RETR-VER90 vertical track corner 90° trimless+circuit corner connector
- 2. MP-RETR-HOR90 horizontal track corner 90° trimless+circuit corner connector
- 3. MP-RETR-EXT90 external track corner 90° trimless+circuit corner connector

Quickinfo

**GENERAL**  
recessed trim  
IP20

**ELECTRICAL**  
NON DIM, DIM DALI, BLE MESH  
transparent feeder cable

**PHYSICAL**  
aluminium  
spray powder

POWER FEEDER UNIT

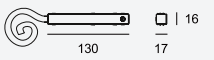

MP-50CON  
power supply connector, CABLE 50CM

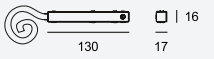

MP-200CON  
power supply connector, CABLE 200CM

CONNECTOR SET

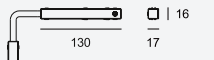

MP-TRCONL  
Track corner connector



MP-TRCON  
Track connector

END CAPS

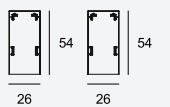

MP-ENDCAP  
End cap





○ ● White as standard

Power	CRI	BeamAngle	Luminous Flux	CCT	Refractive screen	Frame	Model Number
8W	>90	15°	640lm	2700K	gold	white	MP-S108-WG2715
			640lm	3000K	gold	balck	MP-S108-BG3015
			640lm	4000K	gold	white	MP-S108-WG4015
		24°	640lm	2700K	gold	white	MP-S108-WG2724
			640lm	3000K	gold	white	MP-S108-WG3024
			640lm	4000K	gold	balck	MP-S108-BG4024
		38°	640lm	2700K	gold	white	MP-S108-WG2738
			640lm	3000K	gold	balck	MP-S108-BG3038
			640lm	4000K	gold	white	MP-S108-WG4038
		60°	640lm	2700K	gold	balck	MP-S108-BG2760
			640lm	3000K	gold	white	MP-S108-WG3060
			640lm	4000K	gold	white	MP-S108-WG4060

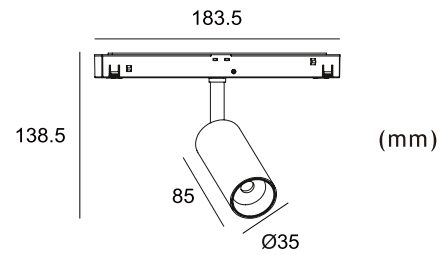

15° 8W

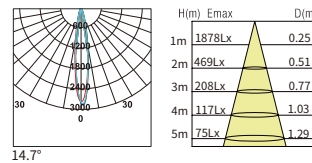

38° 8W

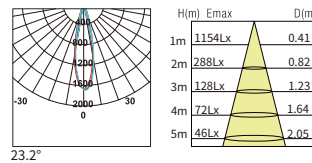

LED & Driver

Bridgelux COB  
 Power: 8W/LED  
 Voltage: 48V  
 SDCM<3  
 Meanwell Driver  
 Output voltage:DC48V  
 Power:100-350W

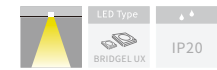

○ ● White as standard

Power	CRI	BeamAngle	Luminous Flux	CCT	Refractive screen	Frame	Model Number
12W	>90	15°	960lm	2700K	gold	white	MP-S112-WG2715
			960lm	3000K	gold	balck	MP-S112-BG3015
			960lm	4000K	gold	white	MP-S112-WG4015
		24°	960lm	2700K	gold	white	MP-S112-WG2724
			960lm	3000K	gold	white	MP-S112-WG3024
			960lm	4000K	gold	balck	MP-S112-BG4024
		38°	960lm	2700K	gold	white	MP-S112-WG2738
			960lm	3000K	gold	balck	MP-S112-BG3038
			960lm	4000K	gold	white	MP-S112-WG4038
		60°	960lm	2700K	gold	balck	MP-S112-BG2760
			960lm	3000K	gold	white	MP-S112-WG3060
			960lm	4000K	gold	white	MP-S112-WG4060

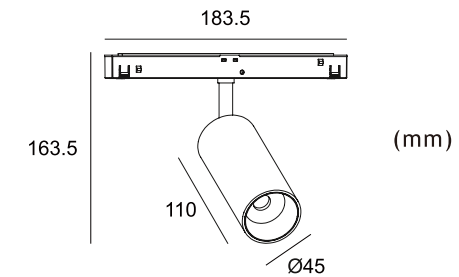

15° 12W

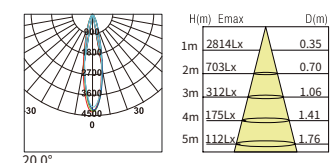

28° 12W

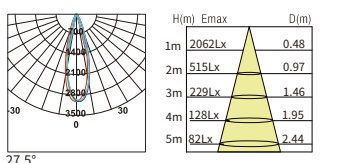

38° 12W

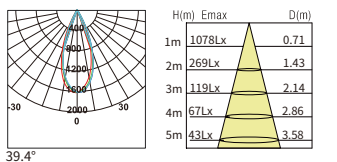

LED & Driver

Bridgelux COB  
 Power: 12W/LED  
 Voltage: 48V  
 SDCM<3  
 Meanwell Driver  
 Output voltage:DC48V  
 Power:100-350W







○ ● White as standard

Power	CRI	BeamAngle	Luminous Flux	CCT	Refractive screen	Frame	Model Number
2×8W	>90	15°	2×640lm	2700K	gold	white	MP-S208-WG2715
			2×640lm	3000K	gold	balck	MP-S208-BG3015
			2×640lm	4000K	gold	white	MP-S208-WG4015
		24°	2×640lm	2700K	gold	white	MP-S208-WG2724
			2×640lm	3000K	gold	white	MP-S208-WG3024
			2×640lm	4000K	gold	balck	MP-S208-BG4024
		38°	2×640lm	2700K	gold	white	MP-S208-WG2738
			2×640lm	3000K	gold	balck	MP-S208-BG3038
			2×640lm	4000K	gold	white	MP-S208-WG4038
		60°	2×640lm	2700K	gold	balck	MP-S208-BG2760
			2×640lm	3000K	gold	white	MP-S208-WG3060
			2×640lm	4000K	gold	white	MP-S208-WG4060

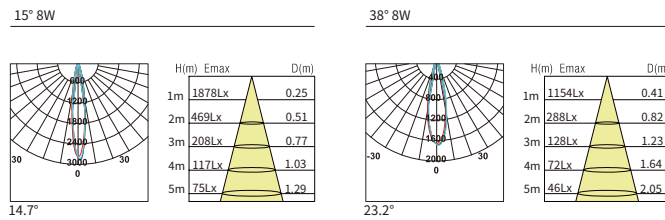
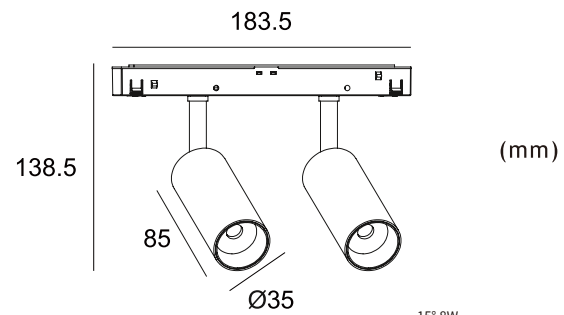

LED & Driver

Bridgelux COB  
 Power: 2\*8W/LED  
 Voltage: 48V  
 SDCM<3  
 Meanwell Driver  
 Output voltage:DC48V  
 Power:100-350W

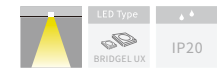

○ ● White as standard

Power	CRI	BeamAngle	Luminous Flux	CCT	Refractive screen	Frame	Model Number
2×12W	>90	15°	2×960lm	2700K	gold	white	MP-S212-WG2715
			2×960lm	3000K	gold	balck	MP-S212-BG3015
			2×960lm	4000K	gold	white	MP-S212-WG4015
		24°	2×960lm	2700K	gold	white	MP-S212-WG2724
			2×960lm	3000K	gold	white	MP-S212-WG3024
			2×960lm	4000K	gold	balck	MP-S212-BG4024
		38°	2×960lm	2700K	gold	white	MP-S212-WG2738
			2×960lm	3000K	gold	balck	MP-S212-BG3038
			2×960lm	4000K	gold	white	MP-S212-WG4038
		60°	2×960lm	2700K	gold	balck	MP-S212-BG2760
			2×960lm	3000K	gold	white	MP-S212-WG3060
			2×960lm	4000K	gold	white	MP-S212-WG4060

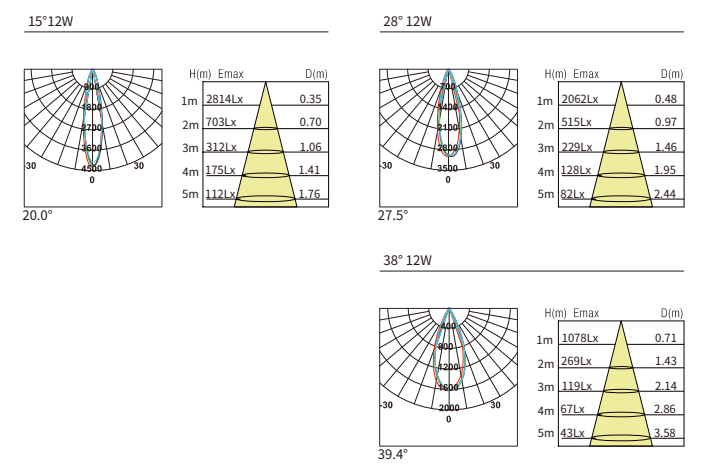
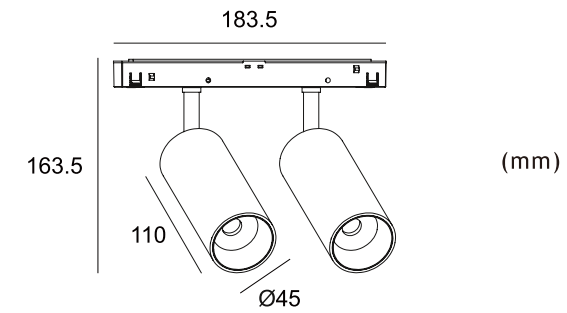

LED & Driver

Bridgelux COB  
 Power: 2\*12W/LED  
 Voltage: 48V  
 SDCM<3  
 Meanwell Driver  
 Output voltage:DC48V  
 Power:100-350W





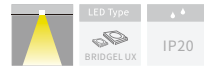

● White as standard

Power	CRI	BeamAngle	Luminous Flux	CCT	Refractive screen	Frame	Model Number
15W	>90	15°	1200lm	2700K	gold	black	MP-S15-WW2715
			1200lm	3000K	gold	black	MP-S15-WW3015
			1200lm	4000K	gold	black	MP-S15-WW4015
		24°	1200lm	2700K	gold	black	MP-S15-WW2724
			1200lm	3000K	gold	black	MP-S15-WW3024
			1200lm	4000K	gold	black	MP-S15-WW4024
		38°	1200lm	2700K	gold	black	MP-S15-WW2738
			1200lm	3000K	gold	black	MP-S15-WW3038
			1200lm	4000K	gold	black	MP-S15-WW4038
60°	1200lm	2700K	gold	black	MP-S15-WW2760		
	1200lm	3000K	gold	black	MP-S15-WW3060		
	1200lm	4000K	gold	black	MP-S15-WW4060		

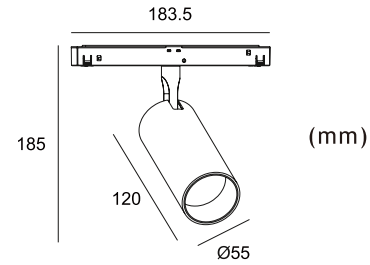

15° 15W

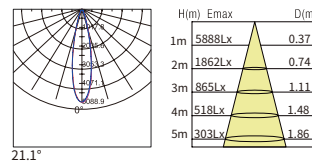

24° 15W

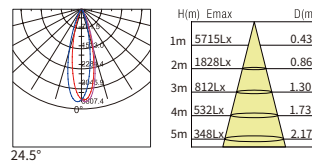

38° 15W

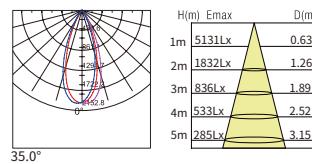

35.0°

LED & Driver

Bridgelux COB  
 Power: 15W/LED  
 Voltage: 48V  
 SDCM<3  
 Meanwell Driver  
 Output voltage:DC48V  
 Power:100-350W

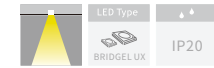

● White as standard

Power	CRI	BeamAngle	Luminous Flux	CCT	Refractive screen	Frame	Model Number
25W	>90	15°	2000lm	2700K	gold	black	MP-S25-WW2715
			2000lm	3000K	gold	black	MP-S25-WW3015
			2000lm	4000K	gold	black	MP-S25-WW4015
			2000lm	2700K	gold	black	MP-S25-WW2724
		24°	2000lm	2700K	gold	black	MP-S25-WW2724
			2000lm	3000K	gold	black	MP-S25-WW3024
			2000lm	4000K	gold	black	MP-S25-WW4024
			2000lm	2700K	gold	black	MP-S25-WW2738
		38°	2000lm	2700K	gold	black	MP-S25-WW2738
			2000lm	3000K	gold	black	MP-S25-WW3038
			2000lm	4000K	gold	black	MP-S25-WW4038
			2000lm	2700K	gold	black	MP-S25-WW2760
60°	2000lm	2700K	gold	black	MP-S25-WW2760		
	2000lm	3000K	gold	black	MP-S25-WW3060		
	2000lm	4000K	gold	black	MP-S25-WW4060		
	2000lm	4000K	gold	black	MP-S25-WW4060		

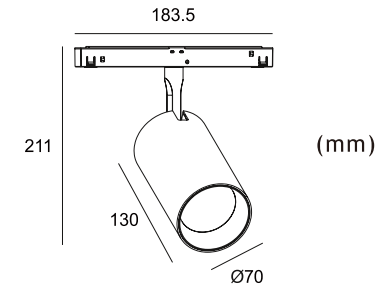

15° 25W

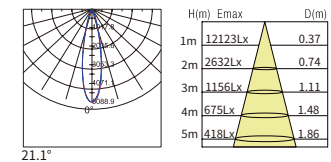

24° 25W

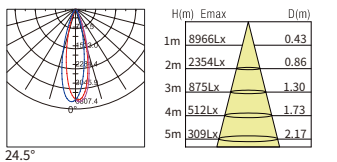

38° 25W

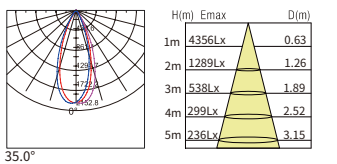

35.0°

LED & Driver

Bridgelux COB  
 Power: 25W/LED  
 Voltage: 48V  
 SDCM<3  
 Meanwell Driver  
 Output voltage:DC48V  
 Power:100-350W







LED Type: BRIDGELUX IP20 White as standard

Power	CRI	BeamAngle	Luminous Flux	CCT	Refractive screen	Frame	Model Number
15W	>90	15-36°	1200lm	2700K	black	black	MP-S15BEA-B2715
			1200lm	3000K	black	black	MP-S15BEA-B3015
			1200lm	4000K	black	black	MP-S15BEA-B4015
		36-60°	1200lm	2700K	black	black	MP-S15BEA-B2760
			1200lm	3000K	black	black	MP-S15BEA-B3060
			1200lm	4000K	black	black	MP-S15BEA-B4060

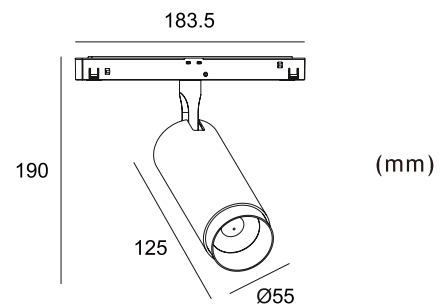

15° 15W

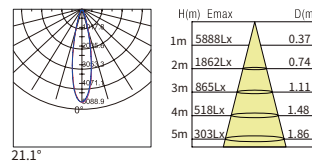

24° 15W

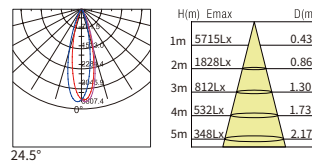

38° 15W

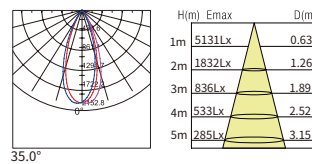

LED & Driver

Bridgelux COB  
 Power: 15W/LED  
 Voltage: 48V  
 SDCM<3  
 Meanwell Driver  
 Output voltage:DC48V  
 Power:100-350W



LED Type: BRIDGELUX IP20 White as standard

Power	CRI	BeamAngle	Luminous Flux	CCT	Refractive screen	Frame	Model Number
25W	>90	15-36°	2000lm	2700K	black	black	MP-S25BEA-B2715
			2000lm	3000K	black	black	MP-S25BEA-B3015
			2000lm	4000K	black	black	MP-S25BEA-B4015
		36-60°	2000lm	2700K	black	black	MP-S25BEA-B2760
			2000lm	3000K	black	black	MP-S25BEA-B3060
			2000lm	4000K	black	black	MP-S25BEA-B4060

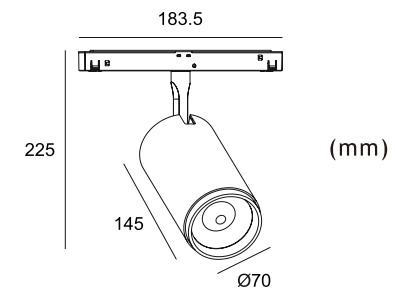

15° 25W

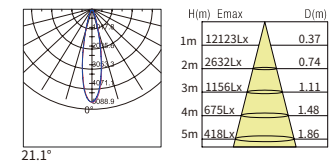

24° 25W

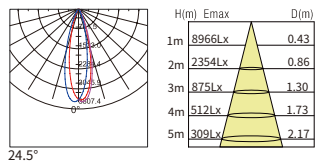

38° 25W

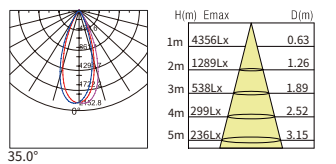

LED & Driver

Bridgelux COB  
 Power: 25W/LED  
 Voltage: 48V  
 SDCM<3  
 Meanwell Driver  
 Output voltage:DC48V  
 Power:100-350W







LED Type: OSRAM IP20 White as standard

Power	CRI	BeamAngle	Luminous Flux	CCT	Refractive screen	Frame	Model Number
8W	>90	15°	640lm	2700K	black	black	MP-R08A-B2715
			640lm	3000K	black	black	MP-R08A-B3015
			640lm	4000K	black	black	MP-R08A-B4015
		24°	640lm	2700K	black	black	MP-R08A-B2724
			640lm	3000K	black	black	MP-R08A-B3024
			640lm	4000K	black	black	MP-R08A-B4024
		38°	640lm	2700K	black	black	MP-R08A-B2738
			640lm	3000K	black	black	MP-R08A-B3038
			640lm	4000K	black	black	MP-R08A-B4038
60°	640lm	2700K	black	black	MP-R08A-B2760		
	640lm	3000K	black	black	MP-R08A-B3060		
	640lm	4000K	black	black	MP-R08A-B4060		

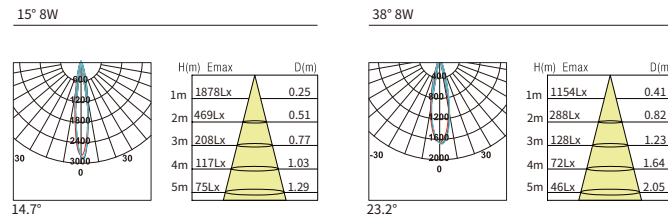
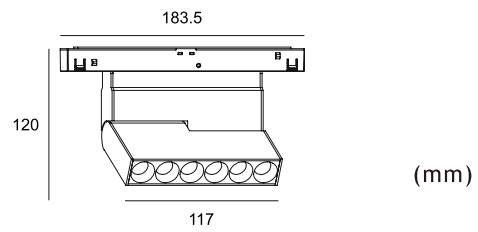

LED & Driver

OSRAM smd  
 Power: 1-2W/LED  
 Voltage: 48V  
 SDCM<3  
 Meanwell Driver  
 Output voltage:DC48V  
 Power:100-350W



LED Type: OSRAM IP20 White as standard

Power	CRI	BeamAngle	Luminous Flux	CCT	Refractive screen	Frame	Model Number
15W	>90	15°	1200lm	2700K	black	black	MP-R15A-B2715
			1200lm	3000K	black	black	MP-R15A-B3015
			1200lm	4000K	black	black	MP-R15A-B4015
			1200lm	2700K	black	black	MP-R15A-B2724
			1200lm	3000K	black	black	MP-R15A-B3024
			1200lm	4000K	black	black	MP-R15A-B4024
		24°	1200lm	2700K	black	black	MP-R15A-B2738
			1200lm	3000K	black	black	MP-R15A-B3038
			1200lm	4000K	black	black	MP-R15A-B4038
			1200lm	2700K	black	black	MP-R15A-B2760
			1200lm	3000K	black	black	MP-R15A-B3060
			1200lm	4000K	black	black	MP-R15A-B4060

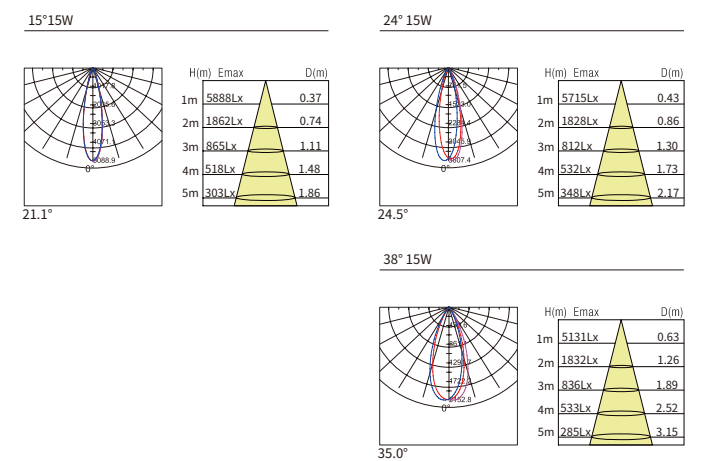
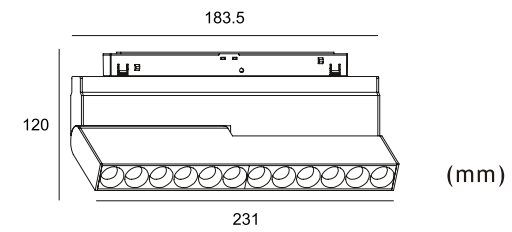

LED & Driver

OSRAM smd  
 Power: 1-2W/LED  
 Voltage: 48V  
 SDCM<3  
 Meanwell Driver  
 Output voltage:DC48V  
 Power:100-350W





LED Type: OSRAM IP20 ● White as standard



Power	CRI	BeamAngle	Luminous Flux	CCT	Refractive screen	Frame	Model Number
8W	>90	15°	640lm	2700K	black	black	MP-R08B-B2715
			640lm	3000K	black	black	MP-R08B-B3015
			640lm	4000K	black	black	MP-R08B-B4015
		24°	640lm	2700K	black	black	MP-R08B-B2724
			640lm	3000K	black	black	MP-R08B-B3024
			640lm	4000K	black	black	MP-R08B-B4024
		38°	640lm	2700K	black	black	MP-R08B-B2738
			640lm	3000K	black	black	MP-R08B-B3038
			640lm	4000K	black	black	MP-R08B-B4038
60°	640lm	2700K	black	black	MP-R08B-B2760		
	640lm	3000K	black	black	MP-R08B-B3060		
	640lm	4000K	black	black	MP-R08B-B4060		

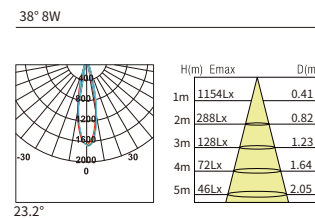
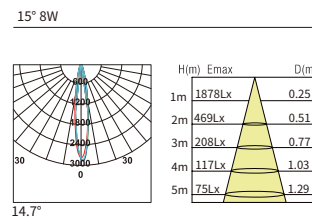
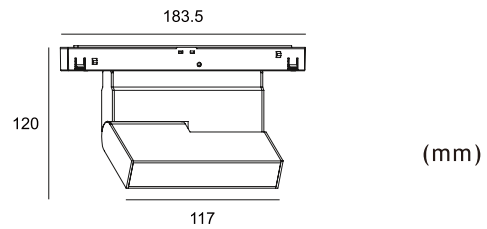

LED & Driver

OSRAM smd  
 Power: 1-2W/LED  
 Voltage: 48V  
 SDCM<3  
 Meanwell Driver  
 Output voltage:DC48V  
 Power:100-350W



LED Type: OSRAM IP20 ● White as standard



Power	CRI	BeamAngle	Luminous Flux	CCT	Refractive screen	Frame	Model Number
15W	>90	15°	1200lm	2700K	black	black	MP-R15B-B2715
			1200lm	3000K	black	black	MP-R15B-B3015
			1200lm	4000K	black	black	MP-R15B-B4015
		24°	1200lm	2700K	black	black	MP-R15B-B2724
			1200lm	3000K	black	black	MP-R15B-B3024
			1200lm	4000K	black	black	MP-R15B-B4024
		38°	1200lm	2700K	black	black	MP-R15B-B2738
			1200lm	3000K	black	black	MP-R15B-B3038
			1200lm	4000K	black	black	MP-R15B-B4038
		60°	1200lm	2700K	black	black	MP-R15B-B2760
			1200lm	3000K	black	black	MP-R15B-B3060
			1200lm	4000K	black	black	MP-R15B-B4060

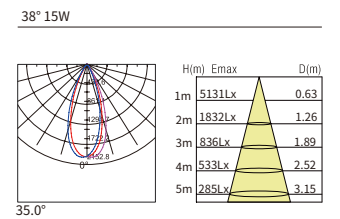
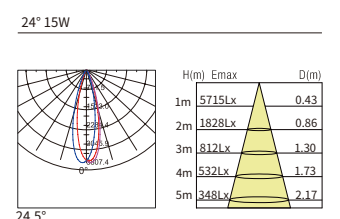
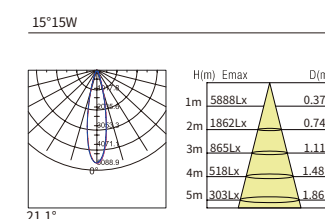
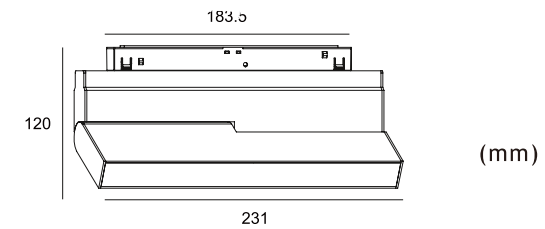

LED & Driver

OSRAM smd  
 Power: 1-2W/LED  
 Voltage: 48V  
 SDCM<3  
 Meanwell Driver  
 Output voltage:DC48V  
 Power:100-350W







LED Type: OSRAM IP20 White as standard

Power	CRI	BeamAngle	Luminous Flux	CCT	Refractive screen	Frame	Model Number
8W	>90	15°	640lm	2700K	black	black	MP-R08F-B2715
			640lm	3000K	black	black	MP-R08F-B3015
			640lm	4000K	black	black	MP-R08F-B4015
		24°	640lm	2700K	black	black	MP-R08F-B2724
			640lm	3000K	black	black	MP-R08F-B3024
			640lm	4000K	black	black	MP-R08F-B4024
		38°	640lm	2700K	black	black	MP-R08F-B2738
			640lm	3000K	black	black	MP-R08F-B3038
			640lm	4000K	black	black	MP-R08F-B4038
		60°	640lm	2700K	black	black	MP-R08F-B2760
			640lm	3000K	black	black	MP-R08F-B3060
			640lm	4000K	black	black	MP-R08F-B4060

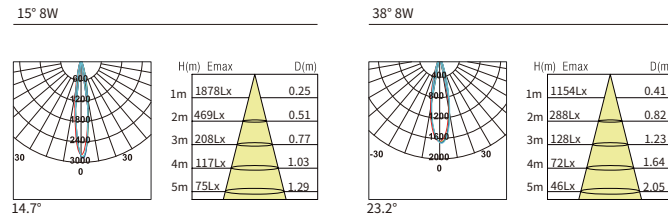
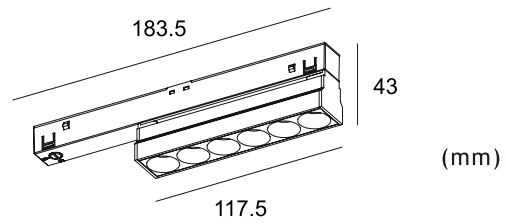

LED & Driver

OSRAM smd  
 Power: 1-2W/LED  
 Voltage: 48V  
 SDCM<3  
 Meanwell Driver  
 Output voltage:DC48V  
 Power:100-350W



LED Type: OSRAM IP20 White as standard

Power	CRI	BeamAngle	Luminous Flux	CCT	Refractive screen	Frame	Model Number
15W	>90	15°	1200lm	2700K	black	black	MP-R15F-B2715
			1200lm	3000K	black	black	MP-R15F-B3015
			1200lm	4000K	black	black	MP-R15F-B4015
		24°	1200lm	2700K	black	black	MP-R15F-B2724
			1200lm	3000K	black	black	MP-R15F-B3024
			1200lm	4000K	black	black	MP-R15F-B4024
		38°	1200lm	2700K	black	black	MP-R15F-B2738
			1200lm	3000K	black	black	MP-R15F-B3038
			1200lm	4000K	black	black	MP-R15F-B4038
		60°	1200lm	2700K	black	black	MP-R15F-B2760
			1200lm	3000K	black	black	MP-R15F-B3060
			1200lm	4000K	black	black	MP-R15F-B4060

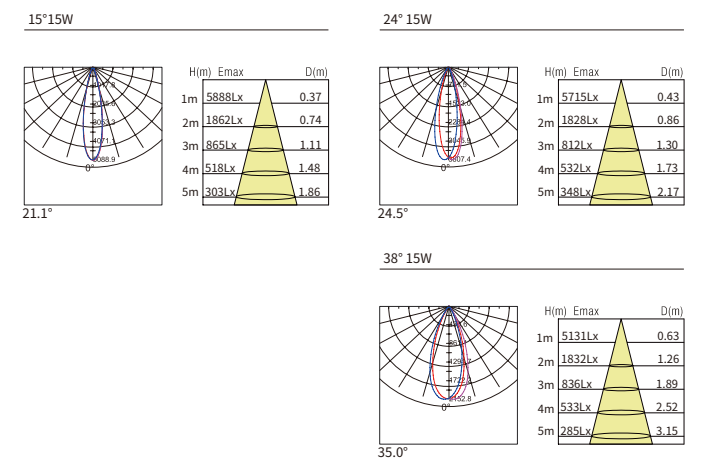
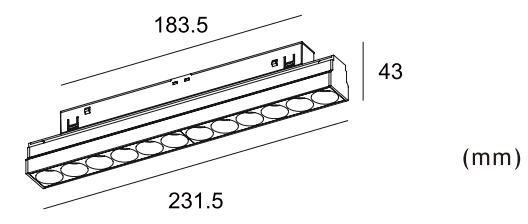

LED & Driver

OSRAM smd  
 Power: 1-2W/LED  
 Voltage: 48V  
 SDCM<3  
 Meanwell Driver  
 Output voltage:DC48V  
 Power:100-350W





● White as standard

Power	CRI	BeamAngle	Luminous Flux	CCT	Refractive screen	Frame	Model Number
10W	>90	112°	800lm	2700K	black	black	MP-L303-B27
			800lm	3000K	black	black	MP-L303-B30
			800lm	4000K	black	black	MP-L303-B40
20W			1600lm	2700K	black	black	MP-L603-B27
			1600lm	3000K	black	black	MP-L603-B30
			1600lm	4000K	black	black	MP-L603-B40
30W			2400lm	2700K	black	black	MP-L903-B27
			2400lm	3000K	black	black	MP-L903-B30
			2400lm	4000K	black	black	MP-L903-B40
40W			3200lm	2700K	black	black	MP-L1203-B27
			3200lm	3000K	black	black	MP-L1203-B30
			3200lm	4000K	black	black	MP-L1203-B40
50W			4000lm	2700K	black	black	MP-L1503-B27
			4000lm	3000K	black	black	MP-L1503-B30
			4000lm	4000K	black	black	MP-L1503-B40



16 183.5

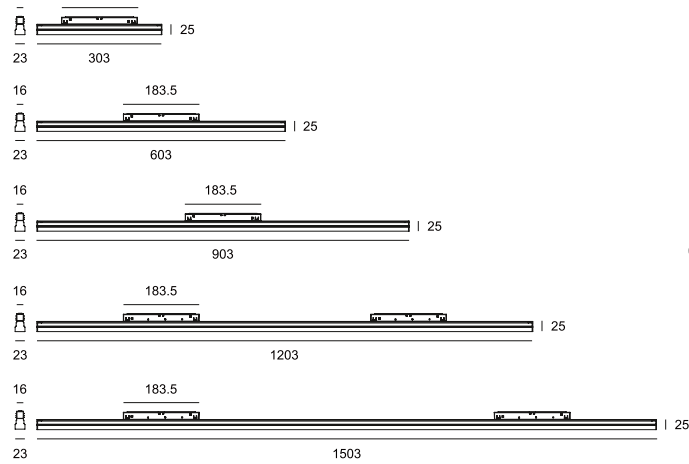

(mm)

LED & Driver

OSRAM smd  
 Power: 0.2W/LED  
 Voltage: 48V  
 SDCM<3  
 Meanwell Driver  
 Output voltage:DC48V  
 Power:100-350W

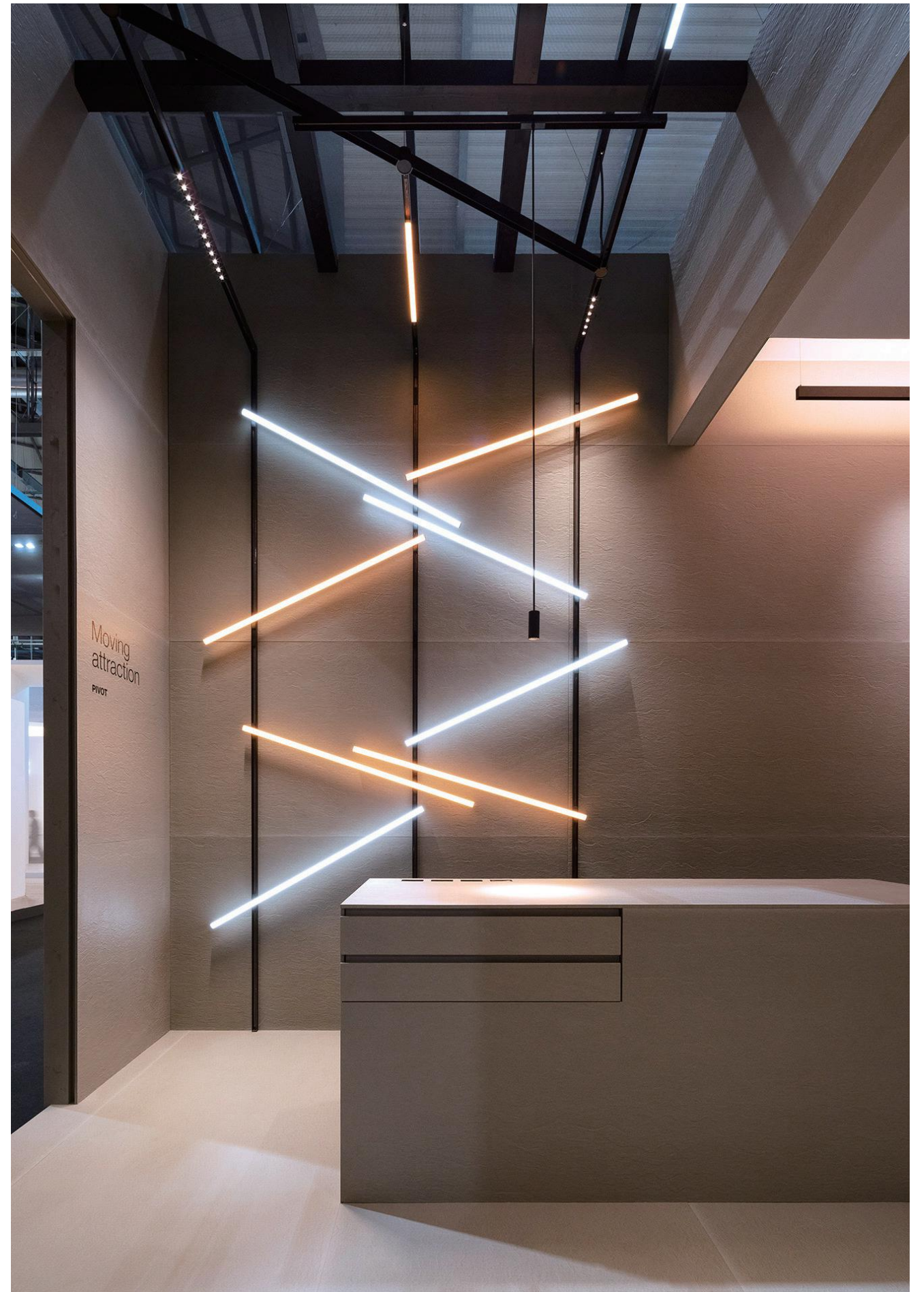



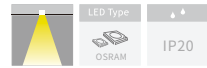

● White as standard

Power	CRI	BeamAngle	Luminous Flux	CCT	Refractive screen	Frame	Model Number
15W	>90	wall washer	1600lm	2700K	black	black	MP-T20WW-B2715
			1600lm	3000K	black	black	MP-T20WW-B3015
			1600lm	4000K	black	black	MP-T20WW-B4015

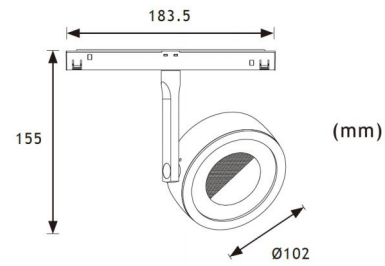

wall washer 15W

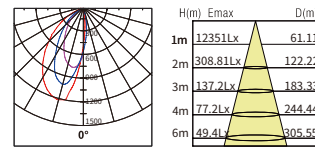

LED & Driver

OSRAM smd  
 Power: 22W/LED  
 Voltage: 48V  
 SDCM<3  
 Meanwell Driver  
 Output voltage:DC48V  
 Power:100-350W





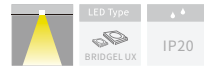

○●● White as standard

Power	CRI	BeamAngle	Luminous Flux	CCT	Refractive screen	Frame	Model Number
10W	>90	15°	800lm	2700K	white	black	MP-SUS10-W2715
			800lm	3000K	black	black	MP-SUS10-B3015
			800lm	4000K	gold	black	MP-SUS10-G4015
		24°	800lm	2700K	white	black	MP-SUS10-W2724
			800lm	3000K	black	black	MP-SUS10-B3024
			800lm	4000K	gold	black	MP-SUS10-G4024
		38°	800lm	2700K	white	black	MP-SUS10-W2738
			800lm	3000K	black	black	MP-SUS10-B3038
			800lm	4000K	gold	black	MP-SUS10-G4038

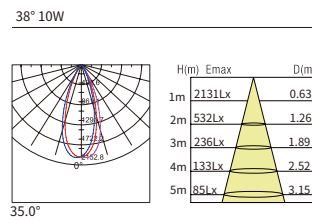
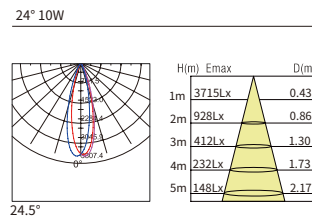
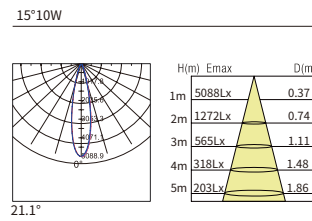
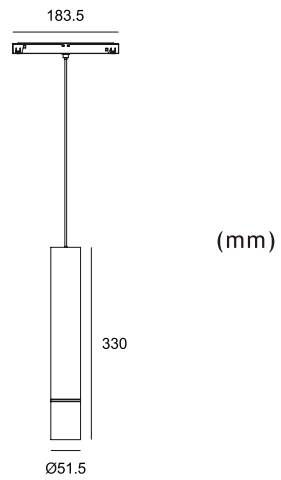

LED & Driver

Bridgelux COB  
 Power: 10W/LED  
 Voltage: 48V  
 SDCM<3  
 Meanwell Driver  
 Output voltage: DC48V  
 Power: 100-350W

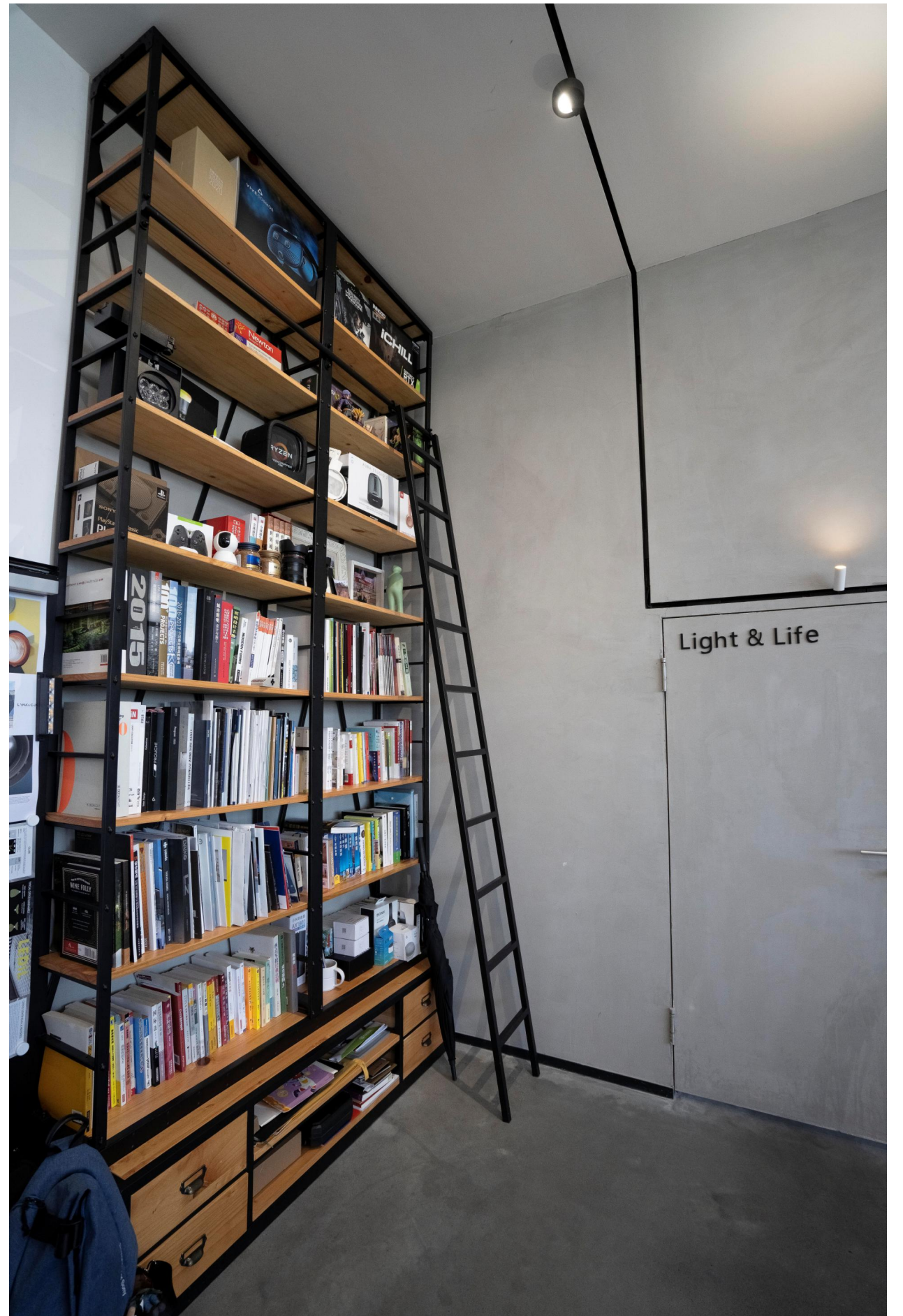





LED Type: BRIDGELUX  
IP20  
White as standard

Power	CRI	BeamAngle	Luminous Flux	CCT	Refractive screen	Frame	Model Number
12W	>90	15°	960lm	2700K	gold	gold	MP-SUS12-G2715
			960lm	3000K	gold	gold	MP-SUS12-G3015
			960lm	4000K	gold	gold	MP-SUS12-G4015
		24°	960lm	2700K	gold	gold	MP-SUS12-G2724
			960lm	3000K	gold	gold	MP-SUS12-G3024
			960lm	4000K	gold	gold	MP-SUS12-G4024
		38°	960lm	2700K	gold	gold	MP-SUS12-G2738
			960lm	3000K	gold	gold	MP-SUS12-G3038
			960lm	4000K	gold	gold	MP-SUS12-G4038

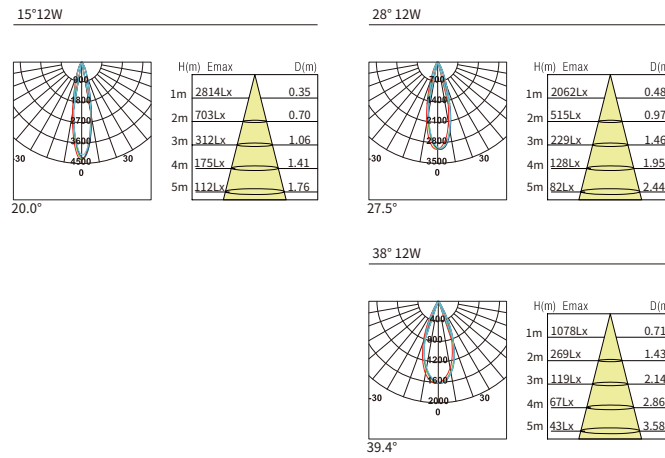
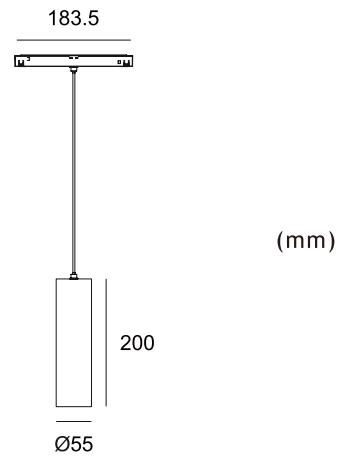

LED & Driver

Bridgelux COB  
Power: 12W/LED  
Voltage: 48V  
SDCM<3  
Meanwell Driver  
Output voltage:DC48V  
Power:100-350W



LED Type: BRIDGELUX  
IP20  
White as standard

Power	CRI	BeamAngle	Luminous Flux	CCT	Refractive screen	Frame	Model Number
15W	>90	15°	1200lm	2700K	gold	gold	MP-SUS15-G2715
			1200lm	3000K	gold	gold	MP-SUS15-G3015
			1200lm	4000K	gold	gold	MP-SUS15-G4015
		24°	1200lm	2700K	gold	gold	MP-SUS15-G2724
			1200lm	3000K	gold	gold	MP-SUS15-G3024
			1200lm	4000K	gold	gold	MP-SUS15-G4024
		38°	1200lm	2700K	gold	gold	MP-SUS15-G2738
			1200lm	3000K	gold	gold	MP-SUS15-G3038
			1200lm	4000K	gold	gold	MP-SUS15-G4038

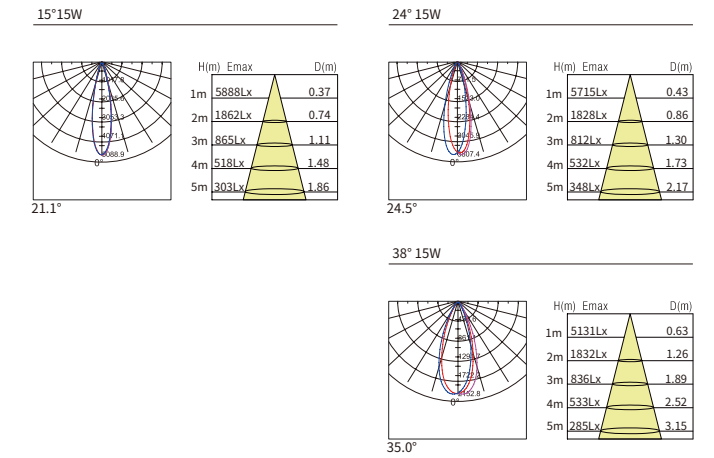
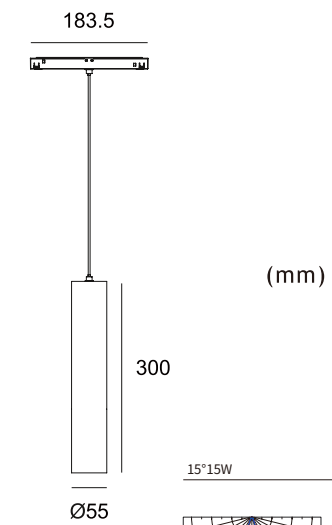

LED & Driver

Bridgelux COB  
Power: 15W/LED  
Voltage: 48V  
SDCM<3  
Meanwell Driver  
Output voltage:DC48V  
Power:100-350W



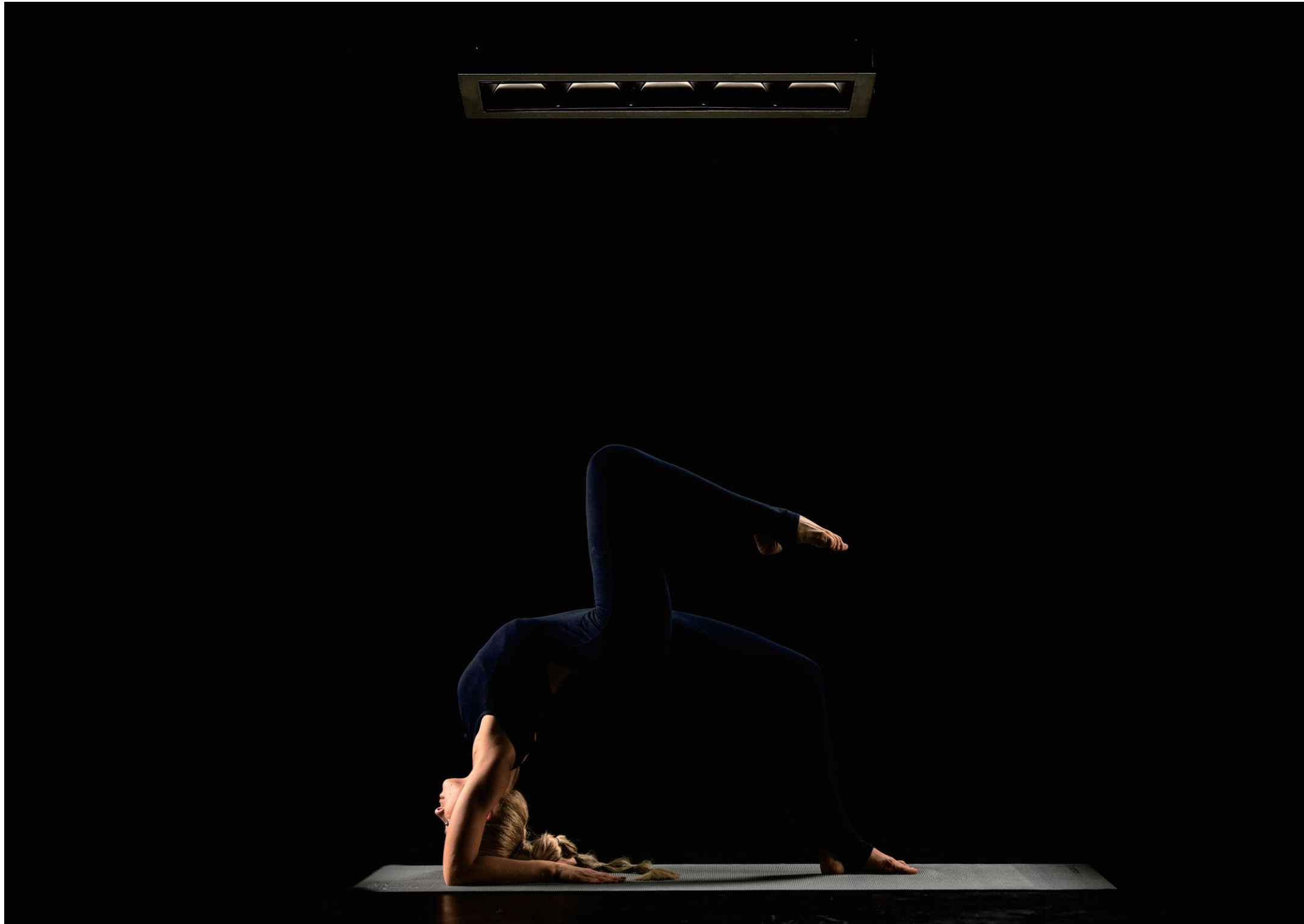

## VISUAL COMFORT AND MINIMUM GLARE

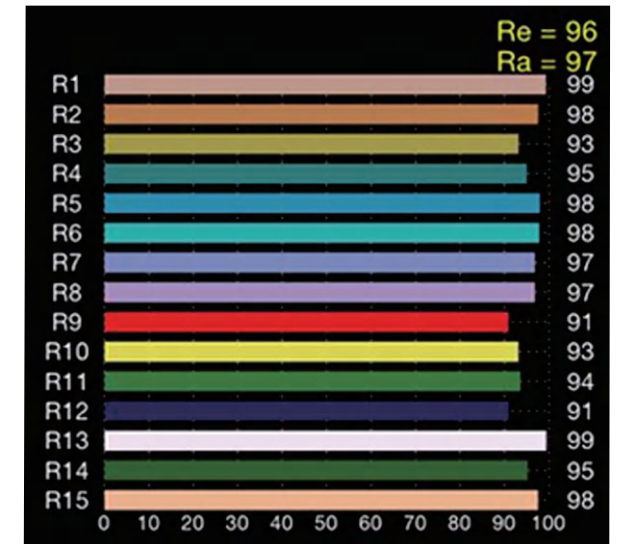
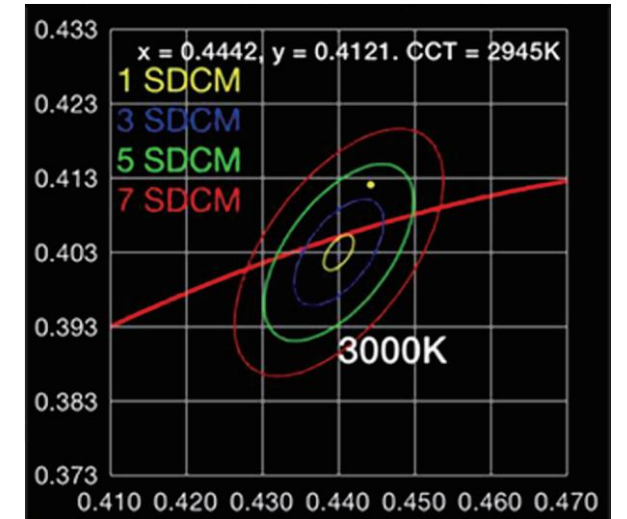

Raster is a luminaire that takes care of the visual comfort of the spaces where it is installed, like no other. Its small-sized reflector, situated in a considerably set back position with respect to the ceiling plane, permits reducing glare, thus offering a very low UGR index (between 16.2 and 16.6).

Even so, the UGR is not a typical characteristic of the luminaire, but of the installation, so the values given in this catalogue have been calculated using standard installation. We recommend the specific calculation of your installation to ensure the desired anti-glare index. All the UGRs in this catalogue have been calculated under the conditions:(4H, 2H)



# RASTER |line to circle

Refractive screen

Color for option: ○ ● ● ● ●

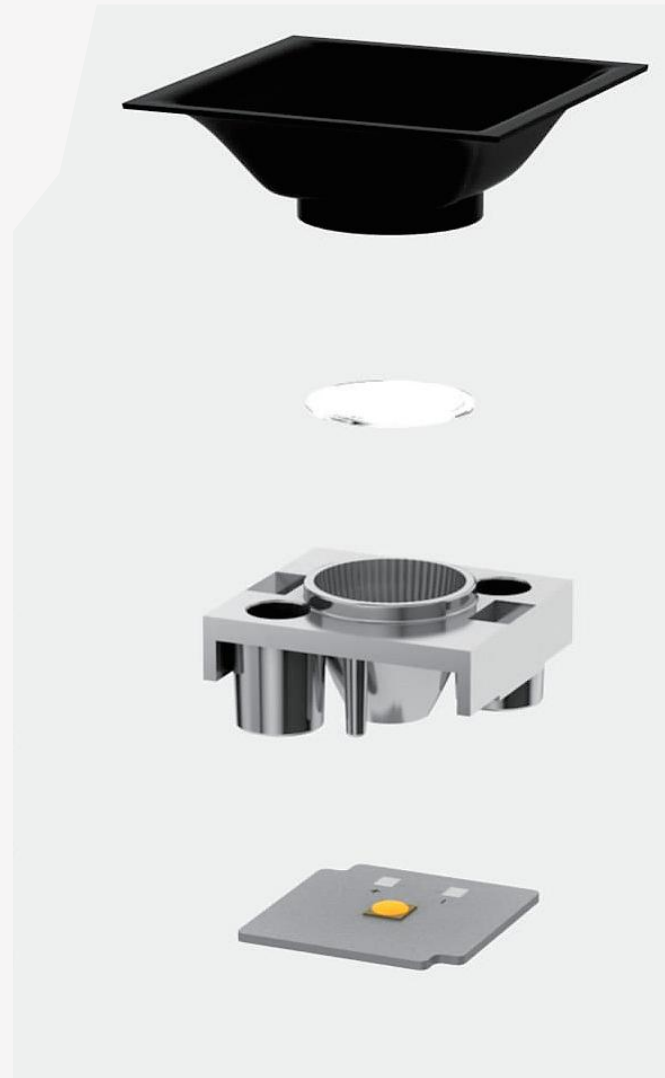

Various optical reflectors

Beam angle: 10°/15°/30°/45°

More wattage in family:

2W/4W/10W/20W/30W

**OSRAM**

High CRI and Low SDCM

Optional filters

Clear lens:



Frosted lens:



Vertical lens:



Woven lens:



## High CRI

Raster's LED products adopt world top class LED chip. Lighting in high power & high CRI makes the subject stand out in color and material feature, and thus perfectly reflecting the colors of the subject and of human beings.

Average CRI evaluation index

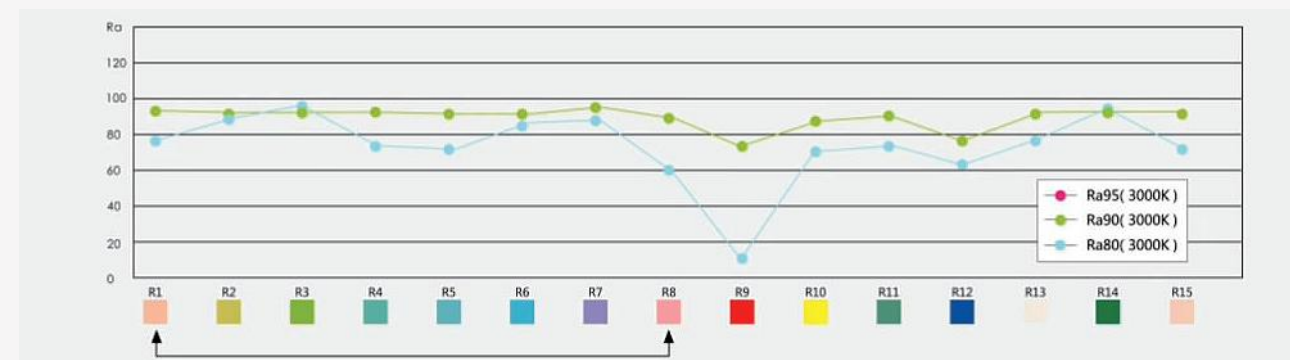

Average color rendering index ranges from R1 to R8 Eight Kinds color rendering index average

## Ultra No Glare, Low UGR

# UGR<16

Deep LED chip, black reflector screen, accurate optics and optional filters

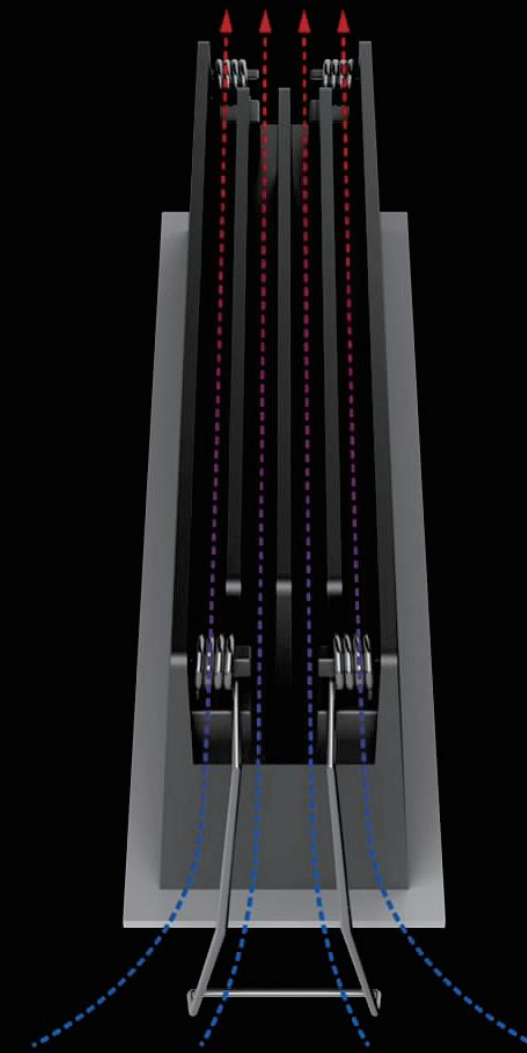
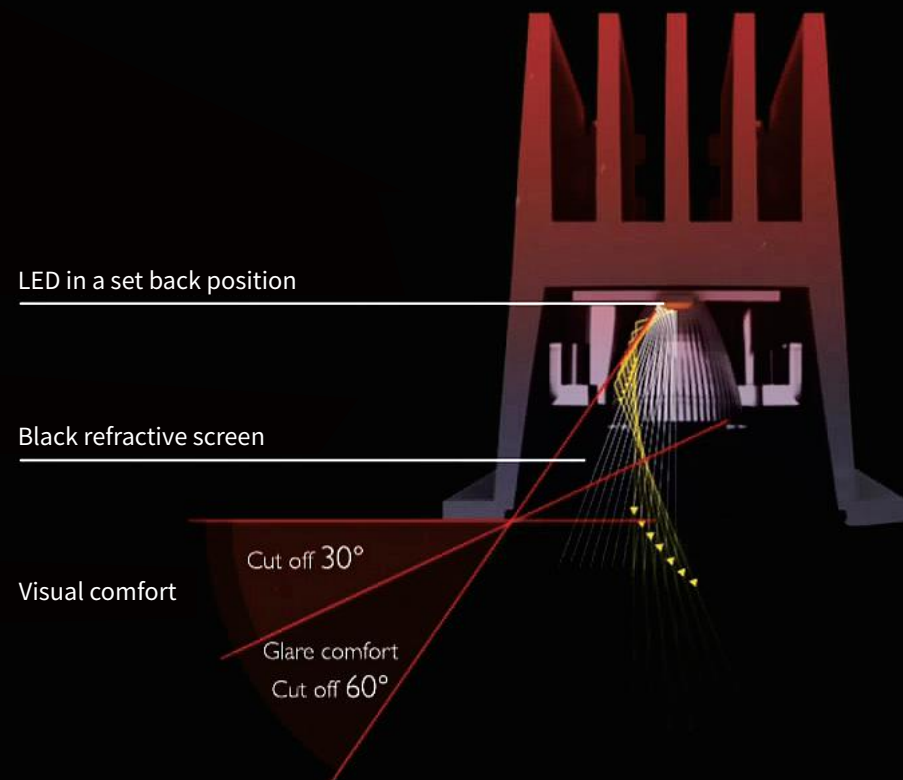

## Color forging radiator

# Upto85%

The heat efficiency, make the lamp more durable, reduce the temperature of the chip light source, reduce the speed of light.





LINEAR DOWNLIGHT | LINE TO CIRCLE  
RASTER

## Lighting effect

Clear lens



Frosted lens

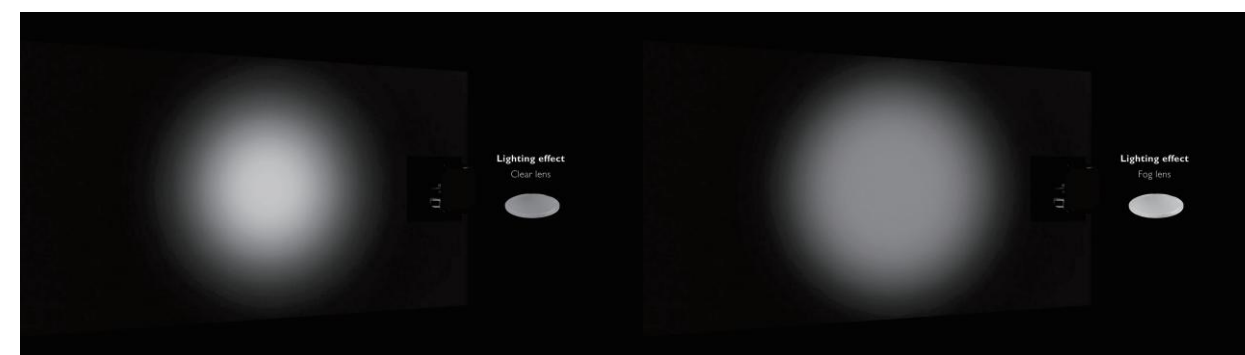

Vertical lens



Woven lens

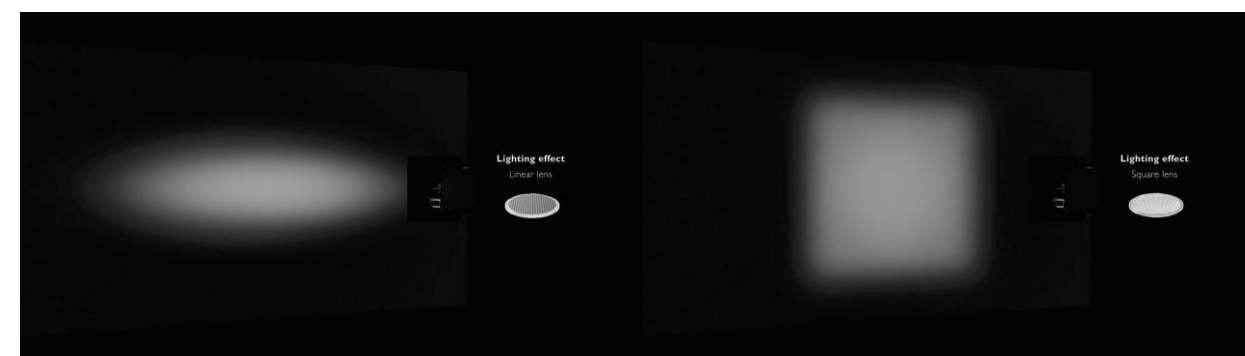
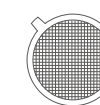

GLOSSY  
WHITE



MATT  
BLACK



MATT  
BLACK



GLOSSY  
WHITE



GLOSSY  
GOLDEN



GLOSSY  
BLACK



GLOSSY  
BLACK



GLOSSY  
ROSE



CHROME

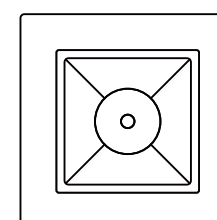
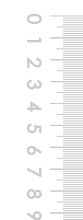

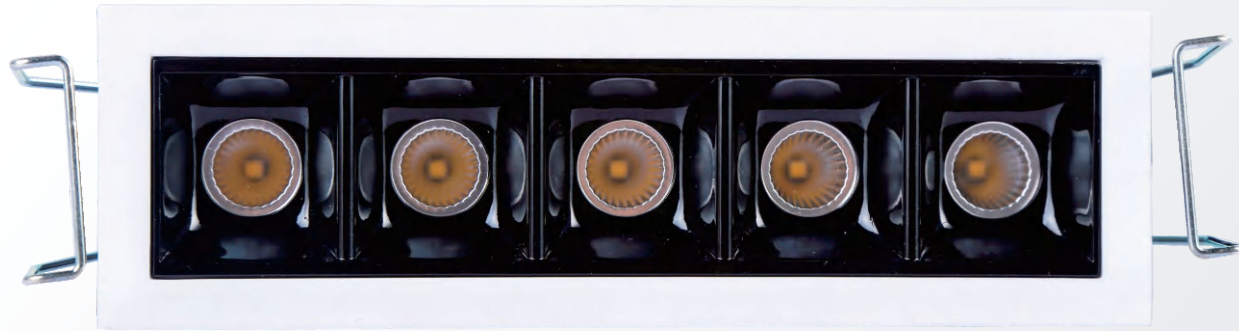

## Raster

RASTER is a revolution of spotlight.  
It is linear lighting fixture, but its light distribution is a perfect round.  
It is small body, but it can light up large areas.  
You can never see where the light comes from, but it  
lights up the article magically with low eco impact and low visual impact.







LED Type: OSRAM IP23 ●○ Black or white as standard

### Raster



Power	CRI	Beam Angle	Luminous Flux	CCT	Refractive screen	Frame	Model Number
2W	>90	15°	140lm	2700K	black	black	RA02-B2715
			145lm	3000K	black	white	RA02-W3015
			150lm	4000K	black	black	RA02-B4015
		30°	140lm	2700K	black	white	RA02-W2730
			145lm	3000K	black	black	RA02-B3030
			150lm	4000K	black	white	RA02-W4030
45°	140lm	2700K	black	black	RA02-B2745		
	145lm	3000K	black	white	RA02-W3045		
	150lm	4000K	black	black	RA02-B4045		

LED Type: OSRAM IP23 ●○ Black or white as standard

### Raster

Power	CRI	Beam Angle	Luminous Flux	CCT	Refractive screen	Frame	Model Number
4W	>90	15°	280lm	2700K	black	black	RA04-B2715
			290lm	3000K	black	white	RA04-W3015
			300lm	4000K	black	black	RA04-B4015
		30°	280lm	2700K	black	white	RA04-W2730
			290lm	3000K	black	black	RA04-B3030
			300lm	4000K	black	white	RA04-W4030
45°	280lm	2700K	black	black	RA04-B2745		
	290lm	3000K	black	white	RA04-W3045		
	300lm	4000K	black	black	RA04-B4045		

(mm)

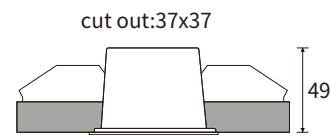
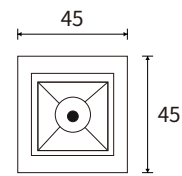

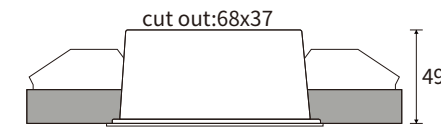
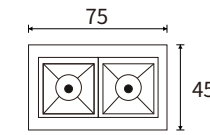
(mm)

#### Filter

- Frosted (standard)
- Clear
- Vertical (optional)
- Woven

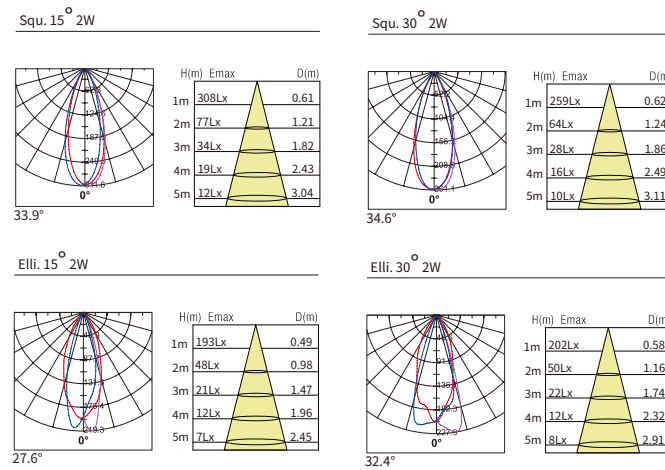

#### LED & Driver

Osram smd3030:  
Power: 3-5W/LED  
Voltage: 3V  
SDCM<3  
Driver:  
Input Voltage:100-277VAC  
/220-240VAC  
Output Current:700mA  
Output Voltage:DC3-8V



G.W.:12.40kgs  
Packaging:32x22x45cm,50PCS/CTN



#### Filter

- Frosted (standard)
- Clear
- Vertical (optional)
- Woven

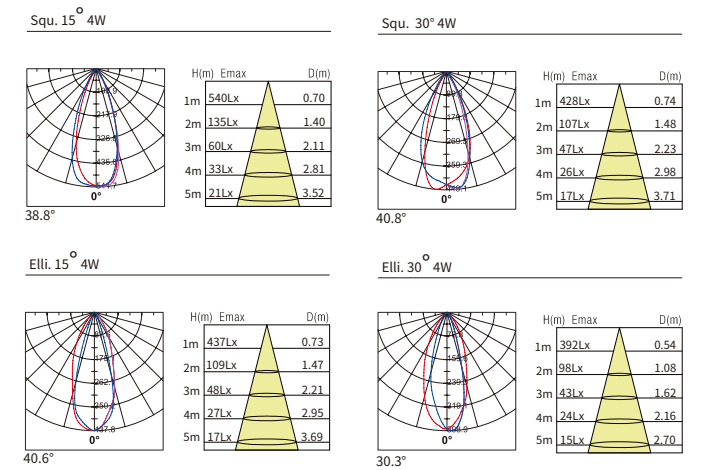

#### LED & Driver

Osram smd3030:  
Power: 3-5W/LED  
Voltage: 3V  
SDCM<3  
Driver:  
Input Voltage:100-277VAC  
/220-240VAC  
Output Current:700mA  
Output Voltage:DC3-8V



G.W.:8.33kgs  
Packaging:32x22x45cm,50PCS/CTN



LED Type: OSRAM IP23 ●○ Black or white as standard **Raster**

Power	CRI	Beam Angle	Luminous Flux	CCT	Refractive screen	Frame	Model Number
10W	>90	10°	700lm	2700K	black	white	RA10-W2710
			725lm	3000K	black	black	RA10-B3010
			750lm	4000K	black	white	RA10-W4010
		15°	700lm	2700K	black	black	RA10-B2715
			725lm	3000K	black	white	RA10-W3015
			750lm	4000K	black	black	RA10-B4015
30°	700lm	2700K	black	white	RA10-W2730		
	725lm	3000K	black	black	RA10-B3030		
	750lm	4000K	black	white	RA10-W4030		
45°	700lm	2700K	black	black	RA10-B2745		
	725lm	3000K	black	white	RA10-W3045		
	750lm	4000K	black	black	RA10-B4045		

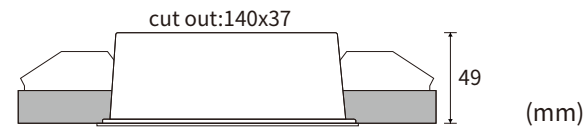
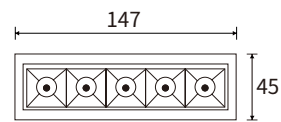

**Filter**

- Frosted (standard)
- Clear (optional)
- Vertical (optional)
- Woven (optional)

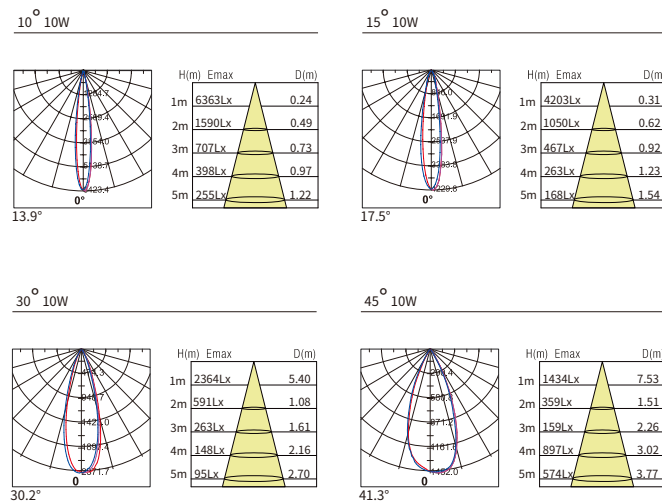

**LED & Driver**

Osram smd3030:  
 Power: 3-5W/LED  
 Voltage: 3V  
 SDCM<3  
 Driver:  
 Input Voltage:100-277VAC  
 /220-240VAC  
 Output Current:550mA  
 Output Voltage:DC8-20V



G.W.:14.50kgs  
 Packaging:35x32x28cm,30PCS/CTN



LED Type: OSRAM IP23 ●○ Black or white as standard **Raster**

Power	CRI	Beam Angle	Luminous Flux	CCT	Refractive screen	Frame	Model Number
20W	>90	10°	1400lm	2700K	black	white	RA20-W2710
			1450lm	3000K	black	black	RA20-B3010
			1500lm	4000K	black	white	RA20-W4010
		15°	1400lm	2700K	black	black	RA20-B2715
			1450lm	3000K	black	white	RA20-W3015
			1500lm	4000K	black	black	RA20-B4015
30°	1400lm	2700K	black	white	RA20-W2730		
	1450lm	3000K	black	black	RA20-B3030		
	1500lm	4000K	black	white	RA20-W4030		
45°	1400lm	2700K	black	black	RA20-B2745		
	1450lm	3000K	black	white	RA20-W3045		
	1500lm	4000K	black	black	RA20-B4045		

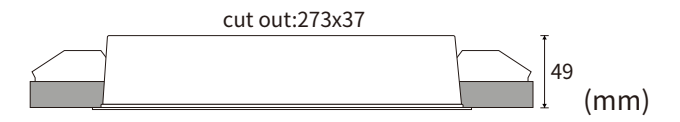
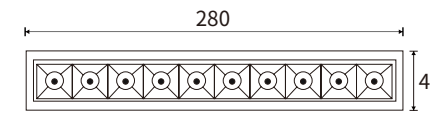

**Filter**

- Frosted (standard)
- Clear (optional)
- Vertical (optional)
- Woven (optional)

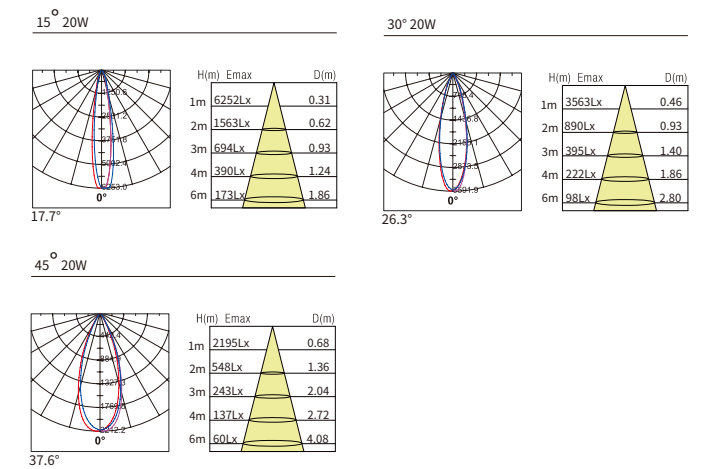

**LED & Driver**

Osram smd3030:  
 Power: 3-5W/LED  
 Voltage: 3V  
 SDCM<3  
 Driver:  
 Input Voltage:100-277VAC  
 /220-240VAC  
 Output Current:600mA  
 Output Voltage:DC25-42V



G.W.:12.30kgs  
 Packaging:32x32x36cm,20PCS/CTN





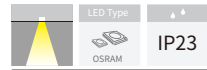

●○ Black or white as standard

## Raster

Power	CRI	Beam Angle	Luminous Flux	CCT	Refractive screen	Frame	Model Number
30W	>90	10°	2100lm	2700K	black	white	RA30-W2710
			2175lm	3000K	black	black	RA30-B3010
			2250lm	4000K	black	white	RA30-W4010
		15°	2100lm	2700K	black	black	RA30-B2715
			2175lm	3000K	black	white	RA30-W3015
			2250lm	4000K	black	black	RA30-B4015
		30°	2100lm	2700K	black	white	RA30-W2730
			2175lm	3000K	black	black	RA30-B3030
			2250lm	4000K	black	white	RA30-W4030
		45°	2100lm	2700K	black	black	RA30-B2745
			2175lm	3000K	black	white	RA30-W3045
			2250lm	4000K	black	black	RA30-B4045

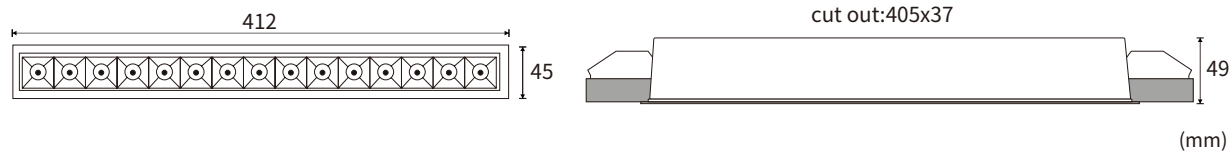
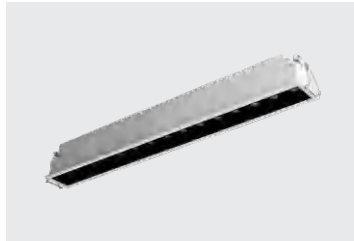

### Filter

- Frosted (standard)
- Clear
- Vertical (optional)
- Woven

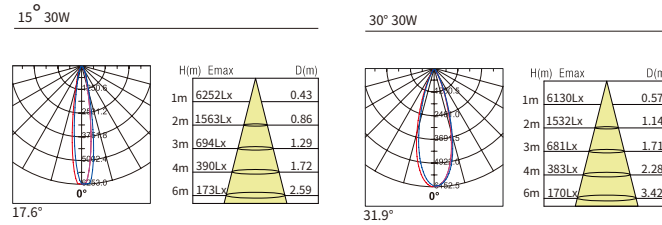

### LED & Driver

Osram smd3030:  
 Power: 3-5W/LED  
 Voltage: 3V  
 SDCM<3  
 Driver:  
 Input Voltage:100-277VAC  
 /220-240VAC  
 Output Current:600mA  
 Output Voltage:DC20-50V



G.W.:13.80kgs  
 Packaging:45x32x19cm,10PCS/CTN



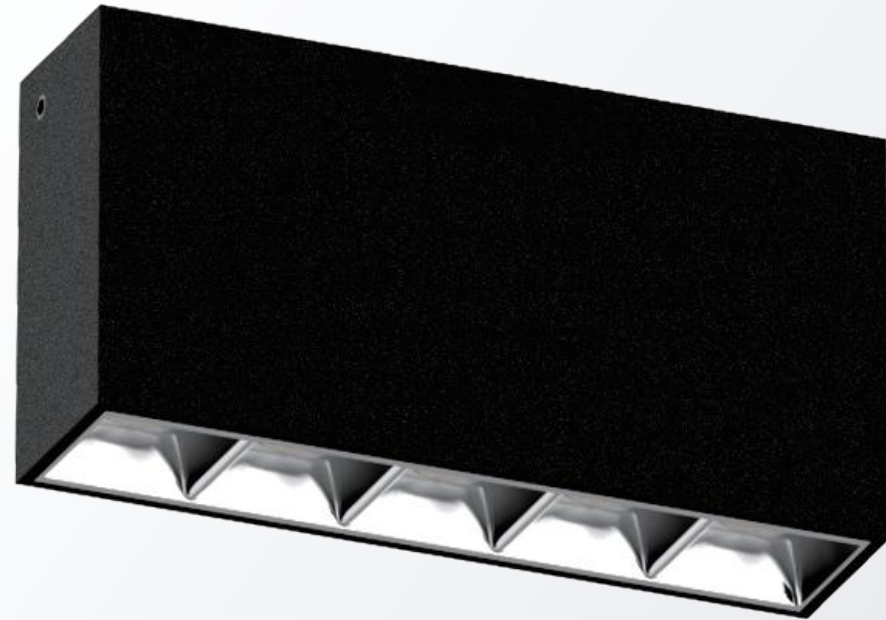

# Raster Surface

Change the optics RASTER is available in surface.  
 Perfect light out-put, clear and uniform.  
 Anti glare and visual comfort.

LED Type: OSRAM  
 IP20 (IP21 for visible body of fitting after installation)  
 ●○ Black or white as standard

Power	CRI	Beam Angle	Luminous Flux	CCT	Refractive screen	Frame	Model Number
4W	>90	15°	270lm	2700K	black	black	RAS04-B2715
			280lm	3000K	black	white	RAS04-W3015
			290lm	4000K	black	black	RAS04-B4015
		30°	270lm	2700K	black	white	RAS04-W2730
			280lm	3000K	black	black	RAS04-B3030
			290lm	4000K	black	white	RAS04-W4030
45°	270lm	2700K	black	black	RAS04-B2745		
	280lm	3000K	black	white	RAS04-W3045		
	290lm	4000K	black	black	RAS04-B4045		

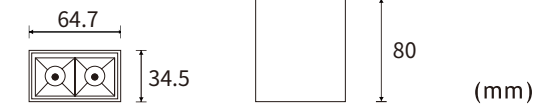

### Filter

- Frosted (standard)
  - Clear
  - Vertical
  - Woven
- (optional)

Squ. 15° 4W

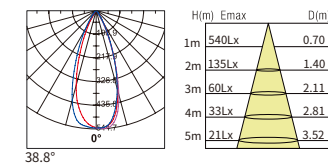

Squ. 30° 4W

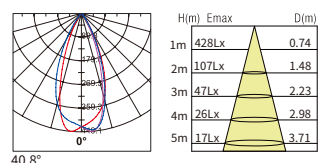

Elli. 15° 4W

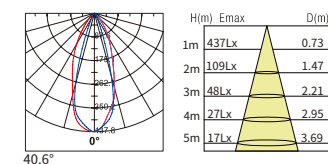

Elli. 30° 4W

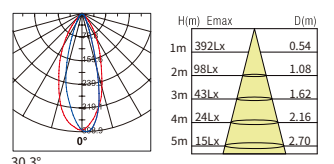

### LED & Driver

Osram smd3030:  
 Power: 3-5W/LED  
 Voltage: 3V  
 SDCM<3  
 Driver:  
 Input Voltage:100-277VAC  
 /220-240VAC  
 Output Current:700mA  
 Output Voltage:DC2-12V



G.W.:8.33kgs  
 Packaging:32x22x34cm,50PCS/CTN





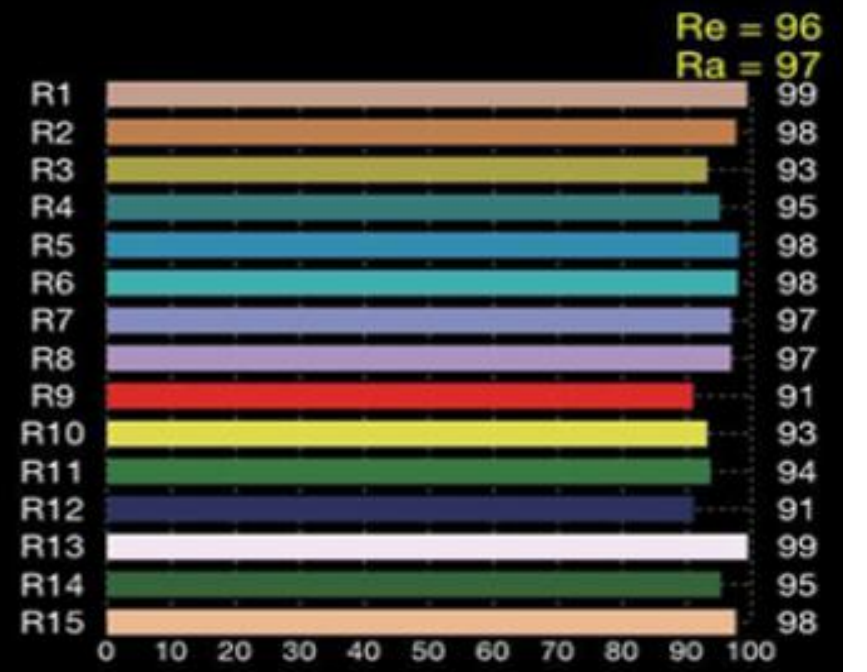
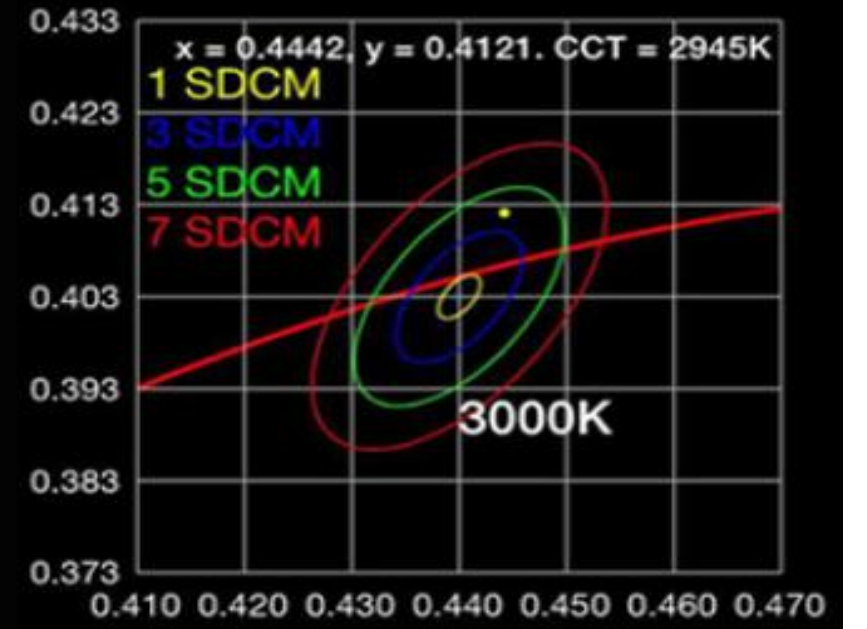

## Raster Surface

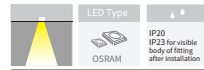



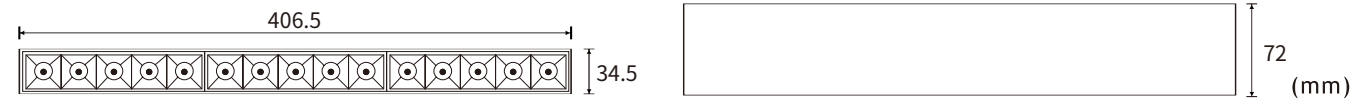
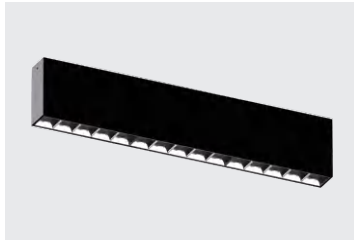
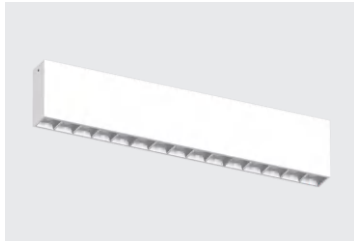

●○ Black or white as standard

Power	CRI	Beam Angle	Luminous Flux	CCT	Refractive screen	Frame	Model Number
30W	>90	10°	2100lm	2700K	black	white	RAS30-W2710
			2150lm	3000K	black	black	RAS30-B3010
			2250lm	4000K	black	white	RAS30-W4010
		15°	2100lm	2700K	black	black	RAS30-B2715
			2150lm	3000K	black	white	RAS30-W3015
			2250lm	4000K	black	black	RAS30-B4015
30°	2100lm	2700K	black	white	RAS30-W2730		
	2150lm	3000K	black	black	RAS30-B3030		
	2200lm	4000K	black	white	RAS30-W4030		
45°	2100lm	2700K	black	black	RAS30-B2745		
	2150lm	3000K	black	white	RAS30-W3045		
	2200lm	4000K	black	black	RAS30-B4045		



### Filter

- Frosted  (standard)
- Clear 
- Vertical  (optional)
- Woven 

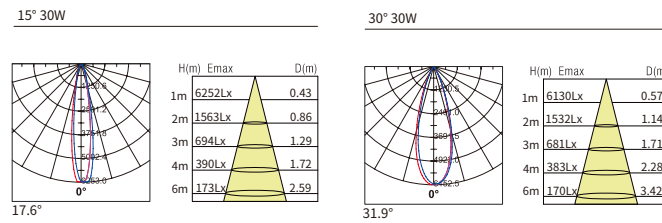

### LED & Driver

Osram smd3030:  
 Power: 3-5W/LED  
 Voltage: 3V  
 SDCM<3  
 Driver:  
 Input Voltage:100-277VAC  
 /220-240VAC  
 Output Current:600mA  
 Output Voltage:DC25-44V



G.W.:10,35kgs  
 Packaging:44x29x25cm,10PCS/CTN







LED Type: OSRAM  
IP20  
IP23 (no visible body of fitting after installation)

●○ Black or white as standard

## Raster Surface

Power CRI Beam Angle Luminous Flux CCT Refractive screen Frame Model Number

Power	CRI	Beam Angle	Luminous Flux	CCT	Refractive screen	Frame	Model Number
10W	>90	10°	650lm	2700K	black	white	RAS10-W2710
			700lm	3000K	black	black	RAS10-B3010
			750lm	4000K	black	white	RAS10-W4010
		15°	650lm	2700K	black	black	RAS10-B2715
			700lm	3000K	black	white	RAS10-W3015
			750lm	4000K	black	black	RAS10-B4015
30°	650lm	2700K	black	white	RAS10-W2730		
	700lm	3000K	black	black	RAS10-B3030		
	750lm	4000K	black	white	RAS10-W4030		
45°	650lm	2700K	black	black	RAS10-B2745		
	700lm	3000K	black	white	RAS10-W3045		
	750lm	4000K	black	black	RAS10-B4045		



LED Type: OSRAM  
IP20  
IP23 (no visible body of fitting after installation)

●○ Black or white as standard

## Raster Surface

Power CRI Beam Angle Luminous Flux CCT Refractive screen Frame Model Number

Power	CRI	Beam Angle	Luminous Flux	CCT	Refractive screen	Frame	Model Number
20W	>90	10°	1400lm	2700K	black	white	RAS20-W2710
			1450lm	3000K	black	black	RAS20-B3010
			1500lm	4000K	black	white	RAS20-W4010
		15°	1400lm	2700K	black	black	RAS20-B2715
			1450lm	3000K	black	white	RAS20-W3015
			1500lm	4000K	black	black	RAS20-B4015
30°	1400lm	2700K	black	white	RAS20-W2730		
	1450lm	3000K	black	black	RAS20-B3030		
	1500lm	4000K	black	white	RAS20-W4030		
45°	1400lm	2700K	black	black	RAS20-B2745		
	1450lm	3000K	black	white	RAS20-W3045		
	1500lm	4000K	black	black	RAS20-B4045		

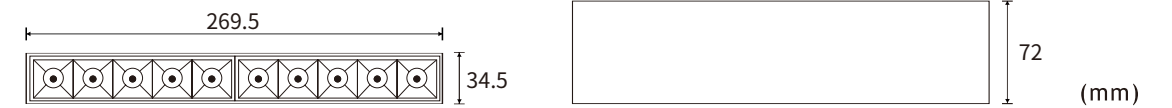

### Filter

- Frosted (standard)
- Clear
- Vertical (optional)
- Woven

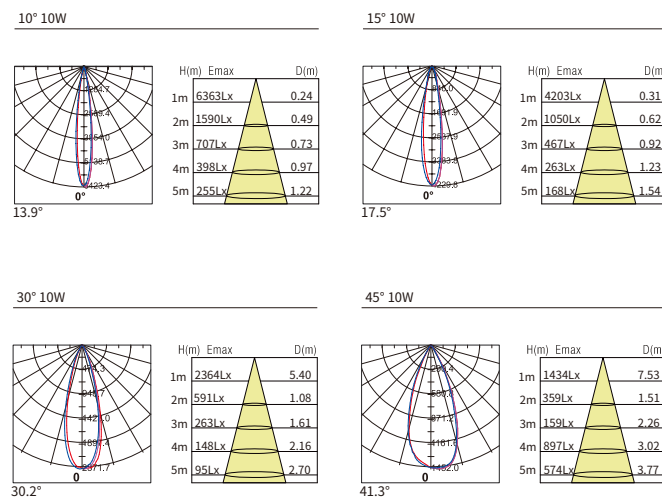

### LED & Driver

Osram smd3030:  
Power: 3-5W/LED  
Voltage: 3V  
SDCM<3  
Driver:  
Input Voltage:100-277VAC  
/220-240VAC  
Output Current:550mA  
Output Voltage:DC12-20V



G.W.:11.13kgs  
Packaging:42x32x25cm,30PCS/CTN



### Filter

- Frosted (standard)
- Clear
- Vertical (optional)
- Woven

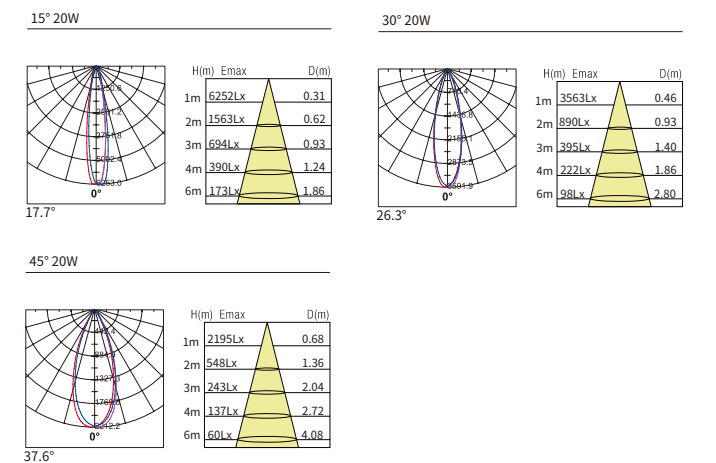

### LED & Driver

Osram smd3030:  
Power: 3-5W/LED  
Voltage: 3V  
SDCM<3  
Driver:  
Input Voltage:100-277VAC  
/220-240VAC  
Output Current:600mA  
Output Voltage:DC25-36V



G.W.:14.06kgs  
Packaging:56x30x25cm,20PCS/CTN



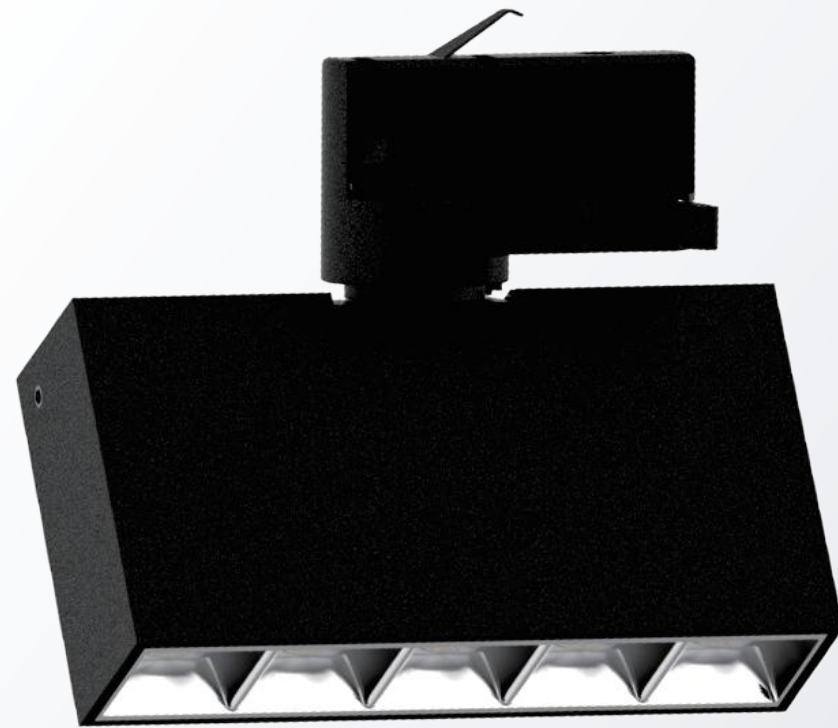

# RasterTrack

Change the optics RASTER is available in track.  
 Perfect light out-put, clear and uniform.  
 Anti glare and visual comfort.

LED Type: OSRAM  
 IP20  
 UV2: See visible body of fitting after installation

●○ Black or white as standard

Power	CRI	Beam Angle	Luminous Flux	CCT	Refractive screen	Frame	Model Number
10W	>90	10°	650lm	2700K	black	white	RATR10-W2710
			700lm	3000K	black	black	RATR10-B3010
			750lm	4000K	black	white	RATR10-W4010
		15°	650lm	2700K	black	black	RATR10-B2715
			700lm	3000K	black	white	RATR10-W3015
			750lm	4000K	black	black	RATR10-B4015
30°	650lm	2700K	black	white	RATR10-W2730		
	700lm	3000K	black	black	RATR10-B3030		
	750lm	4000K	black	white	RATR10-W4030		
45°	650lm	2700K	black	black	RATR10-B2745		
	700lm	3000K	black	white	RATR10-W3045		
	750lm	4000K	black	black	RATR10-B4045		

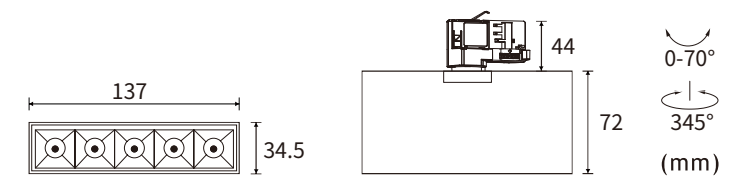

### Filter

- Frosted (standard)
  - Clear
  - Vertical
  - Woven
- (optional)

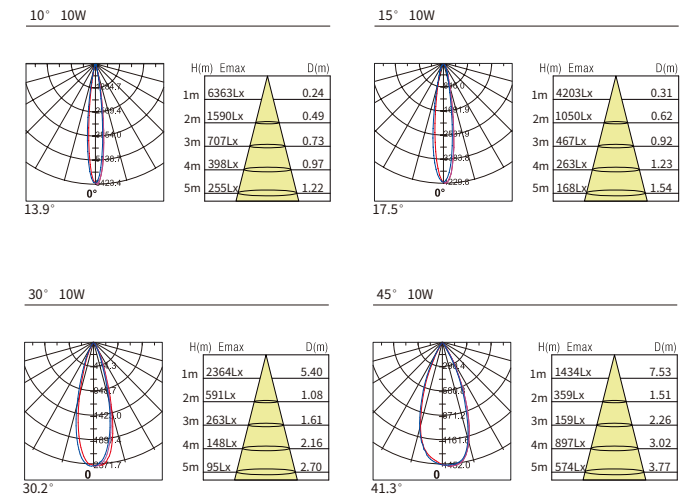

### LED & Driver

Osram smd3030:  
 Power: 3-5W/LED  
 Voltage: 3V  
 SDCM<3  
 Driver:  
 Input Voltage:100-277VAC  
 /220-240VAC  
 Output Current:550mA  
 Output Voltage:DC12-20V



G.W.:14.50kgs  
 Packaging:34x32x36cm,40PCS/CTN





LED Type: OSRAM IP20 IP23 for visible body of fitting after installation  
 ●○ Black or white as standard  
**Raster Track**

Power	CRI	Beam Angle	Luminous Flux	CCT	Refractive screen	Frame	Model Number
20W	>90	10°	1400lm	2700K	black	white	RATR20-W2710
			1450lm	3000K	black	black	RATR20-B3010
			1500lm	4000K	black	white	RATR20-W4010
		15°	1400lm	2700K	black	black	RATR20-B2715
			1450lm	3000K	black	white	RATR20-W3015
			1500lm	4000K	black	black	RATR20-B4015
30°	1400lm	2700K	black	white	RATR20-W2730		
	1450lm	3000K	black	black	RATR20-B3030		
	1500lm	4000K	black	white	RATR20-W4030		
45°	1400lm	2700K	black	black	RATR20-B2745		
	1450lm	3000K	black	white	RATR20-W3045		
	1500lm	4000K	black	black	RATR20-B4045		

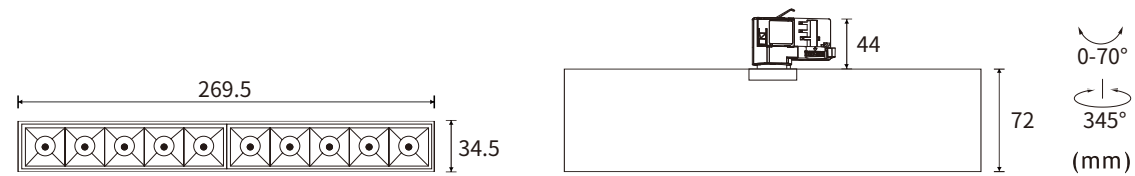
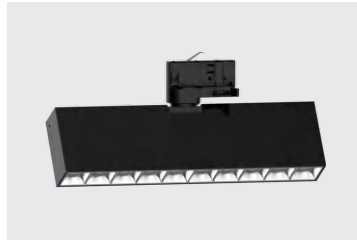
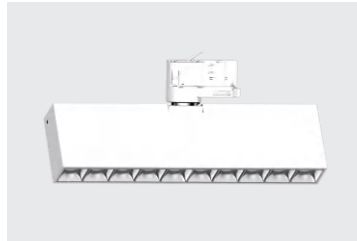

**Filter**

- Frosted (standard)
- Clear
- Vertical (optional)
- Woven (optional)

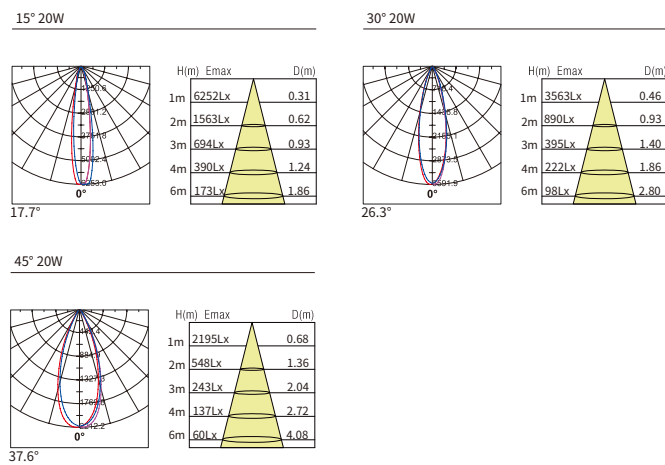

**LED & Driver**

Osram smd3030:  
 Power: 3-5W/LED  
 Voltage: 3V  
 SDCM<3  
 Driver:  
 Input Voltage:100-277VAC /220-240VAC  
 Output Current:600mA  
 Output Voltage:DC25-36V



G.W.:12.30kgs  
 Packaging:32x32x36cm,20PCS/CTN



LED Type: OSRAM IP20 IP23 for visible body of fitting after installation  
 ●○ Black or white as standard  
**Raster Track**

Power	CRI	Beam Angle	Luminous Flux	CCT	Refractive screen	Frame	Model Number
30W	>90	10°	2100lm	2700K	black	white	RATR30-W2710
			2150lm	3000K	black	black	RATR30-B3010
			2250lm	4000K	black	white	RATR30-W4010
		15°	2100lm	2700K	black	black	RATR30-B2715
			2150lm	3000K	black	white	RATR30-W3015
			2250lm	4000K	black	black	RATR30-B4015
30°	2100lm	2700K	black	white	RATR30-W2730		
	2150lm	3000K	black	black	RATR30-B3030		
	2200lm	4000K	black	white	RATR30-W4030		
45°	2100lm	2700K	black	black	RATR30-B2745		
	2150lm	3000K	black	white	RATR30-W3045		
	2200lm	4000K	black	black	RATR30-B4045		

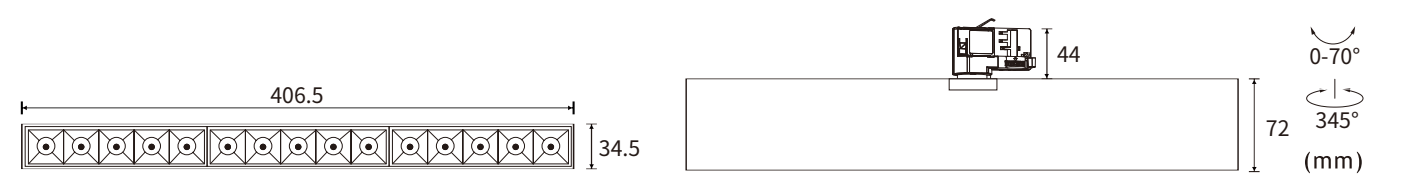
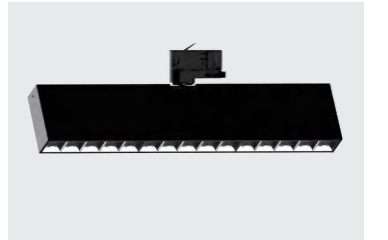
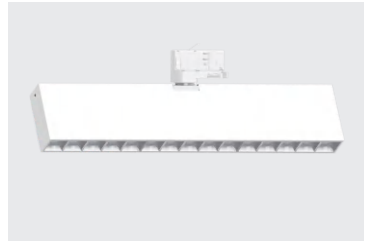

**Filter**

- Frosted (standard)
- Clear
- Vertical (optional)
- Woven (optional)

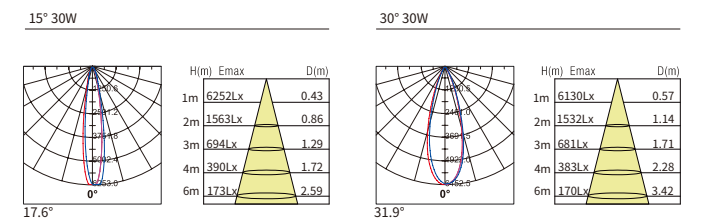

**LED & Driver**

Osram smd3030:  
 Power: 3-5W/LED  
 Voltage: 3V  
 SDCM<3  
 Driver:  
 Input Voltage:100-277VAC /220-240VAC  
 Output Current:600mA  
 Output Voltage:DC25-44V



G.W.:13.80kgs  
 Packaging:45x32x27cm,15PCS/CTN



# Raster trimless

Hidden in the ceiling of white or black.  
Main body replacement supported after years using.  
Optics changeable to general lighting, wall washer, spotlight.

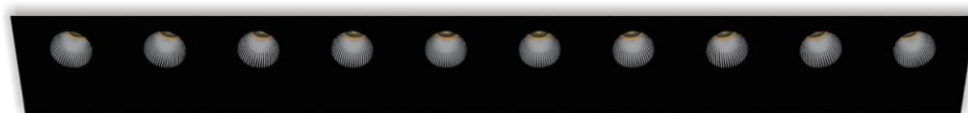
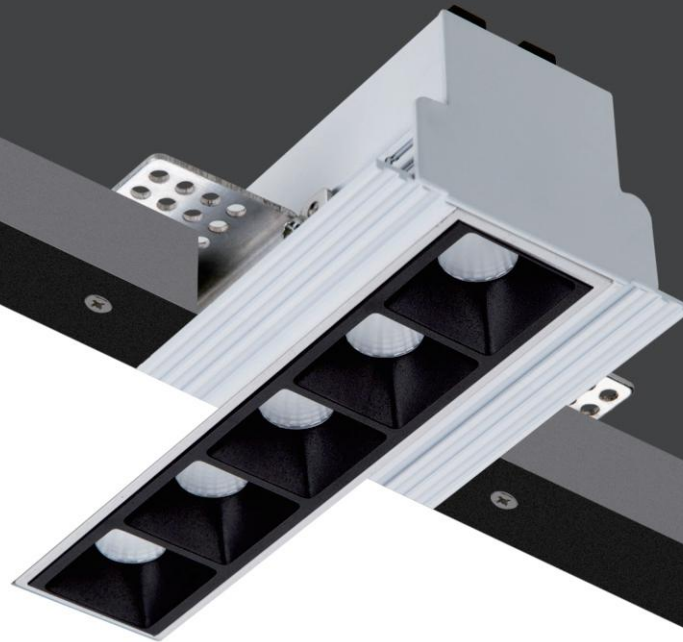

LED Type: OSRAM  
IP23  
White as standard

Power	CRI	Beam Angle	Luminous Flux	CCT	Refractive screen	Frame	Model Number
4W	>90	15°	280lm	2700K	black	black	RAT04-B2715
			290lm	3000K	black	white	RAT04-W3015
			300lm	4000K	black	black	RAT04-B4015
		30°	280lm	2700K	black	white	RAT04-W2730
			290lm	3000K	black	black	RAT04-B3030
			300lm	4000K	black	white	RAT04-W4030
		45°	280lm	2700K	black	black	RAT04-B2745
			290lm	3000K	black	white	RAT04-W3045
			300lm	4000K	black	black	RAT04-B4045

# Raster trimless

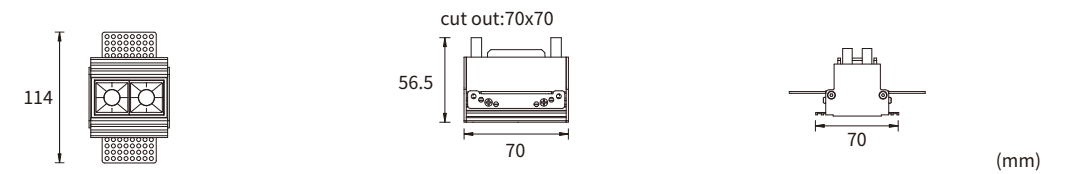

### Filter

- Frosted (standard)
  - Clear
  - Vertical
  - Woven
- (optional)

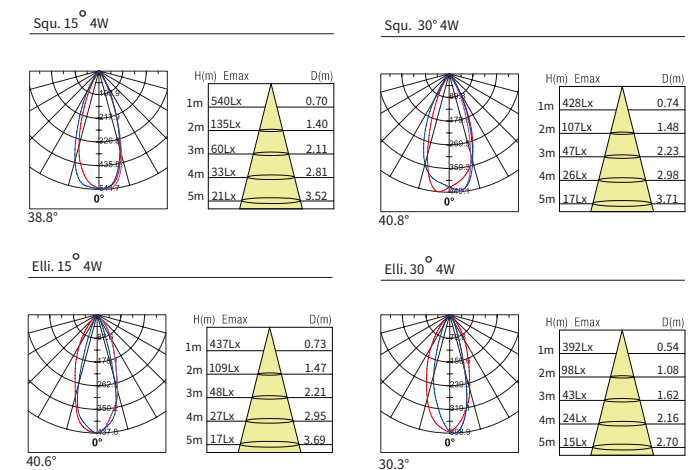

### LED & Driver

Osram smd3030:  
Power: 3-5W/LED  
Voltage: 3V  
SDCM<3  
Driver:  
Input Voltage:100-277VAC  
/220-240VAC  
Output Current:600mA  
Output Voltage:DC25-42V



G.W.:14.5kgs  
Packaging:42x20x42cm,50PCS/CTN





### Raster trimless

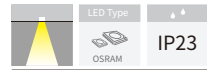

○ White as standard

Power	CRI	Beam Angle	Luminous Flux	CCT	Refractive screen	Frame	Model Number
30W	>90	10°	2100lm	2700K	black	white	RAT30-W2710
			2175lm	3000K	black	black	RAT30-B3010
			2250lm	4000K	black	white	RAT30-W4010
		15°	2100lm	2700K	black	black	RAT30-B2715
			2175lm	3000K	black	white	RAT30-W3015
			2250lm	4000K	black	black	RAT30-B4015
30°	2100lm	2700K	black	white	RAT30-W2730		
	2175lm	3000K	black	black	RAT30-B3030		
	2250lm	4000K	black	white	RAT30-W4030		
45°	2100lm	2700K	black	black	RAT30-B2745		
	2175lm	3000K	black	white	RAT30-W3045		
	2250lm	4000K	black	black	RAT30-B4045		

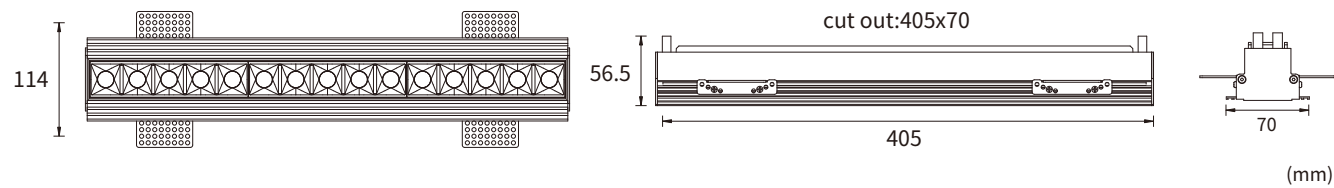
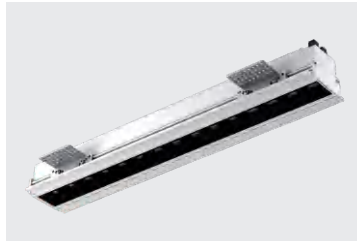

#### Filter

- Frosted (standard)
- Clear
- Vertical (optional)
- Woven

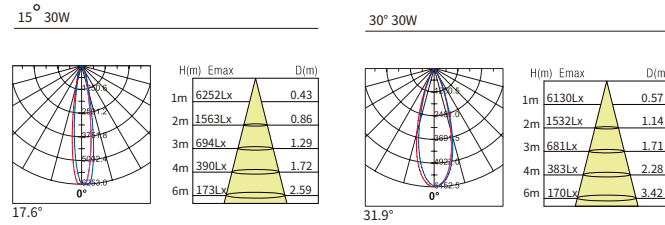

#### LED & Driver

Osram smd3030:  
 Power: 3-5W/LED  
 Voltage: 3V  
 SDCM<3  
 Driver:  
 Input Voltage:100-277VAC  
 /220-240VAC  
 Output Current:600mA  
 Output Voltage:DC20-50V



G.W.:11.38kgs  
 Packaging:44x42x18cm,10PCS/CTN

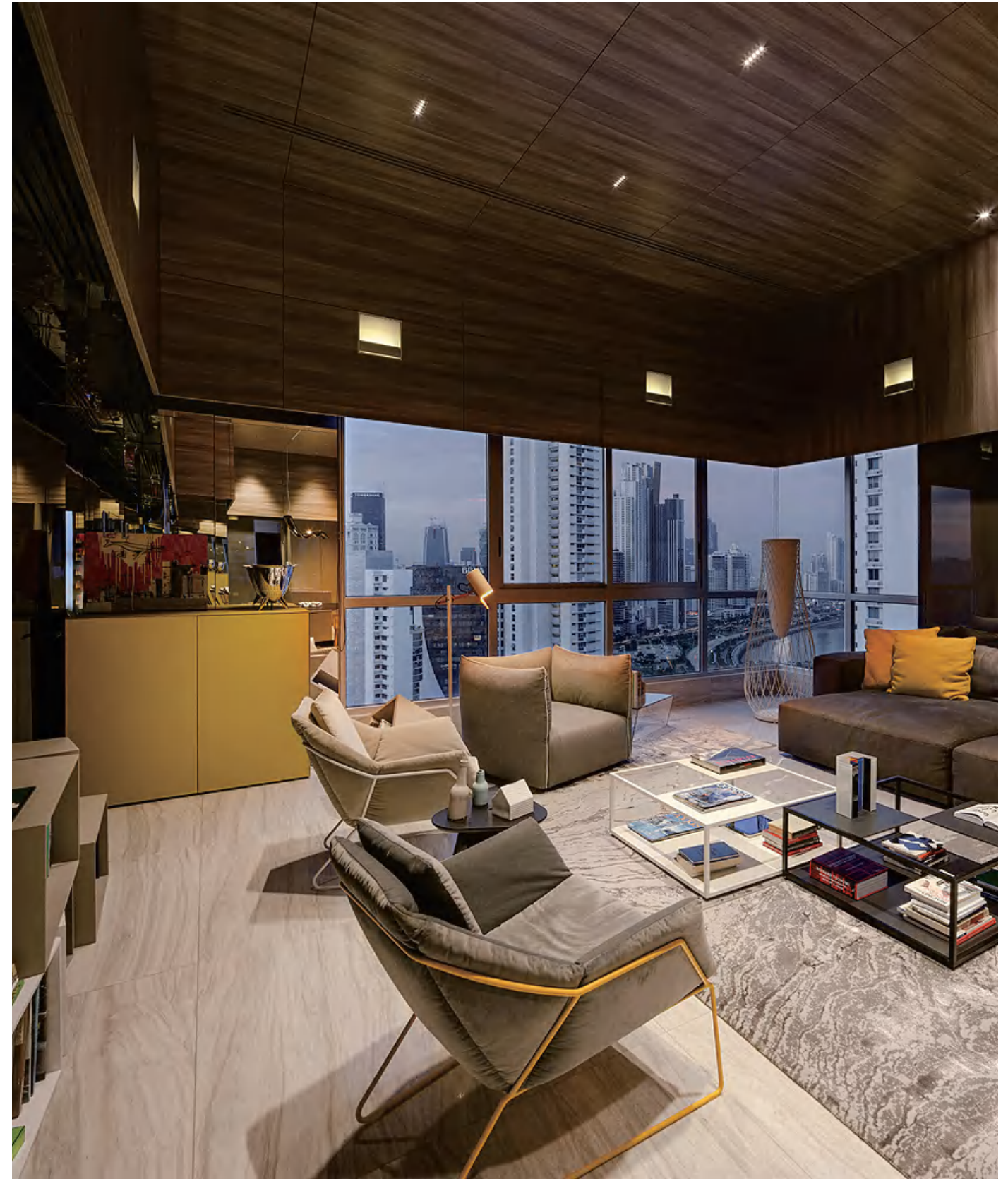

LED Type: OSRAM IP23 White as standard **Raster trimless**

Power	CRI	Beam Angle	Luminous Flux	CCT	Refractive screen	Frame	Model Number
10W	>90	10°	700lm	2700K	black	white	RAT10-W2710
			725lm	3000K	black	black	RAT10-B3010
			750lm	4000K	black	white	RAT10-W4010
		15°	700lm	2700K	black	black	RAT10-B2715
			725lm	3000K	black	white	RAT10-W3015
			750lm	4000K	black	black	RAT10-B4015
30°	700lm	2700K	black	white	RAT10-W2730		
	725lm	3000K	black	black	RAT10-B3030		
	750lm	4000K	black	white	RAT10-W4030		
45°	700lm	2700K	black	black	RAT10-B2745		
	725lm	3000K	black	white	RAT10-W3045		
	750lm	4000K	black	black	RAT10-B4045		

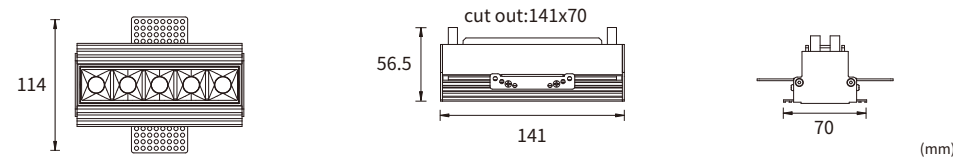

Filter

- Frosted (standard)
- Clear
- Vertical (optional)
- Woven

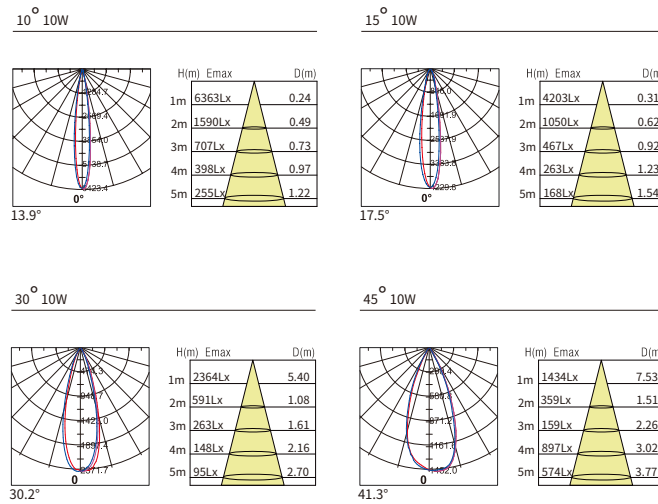

LED & Driver

Osram smd3030:  
Power: 3-5W/LED  
Voltage: 3V  
SDCM<3  
Driver:  
Input Voltage:100-277VAC  
/220-240VAC  
Output Current:550mA  
Output Voltage:DC8-20V



G.W.:14.37kgs  
Packaging:42x34x26cm,30PCS/CTN



LED Type: OSRAM IP23 White as standard **Raster trimless**

Power	CRI	Beam Angle	Luminous Flux	CCT	Refractive screen	Frame	Model Number
20W	>90	10°	1400lm	2700K	black	white	RAT20-W2710
			1450lm	3000K	black	black	RAT20-B3010
			1500lm	4000K	black	white	RAT20-W4010
		15°	1400lm	2700K	black	black	RAT20-B2715
			1450lm	3000K	black	white	RAT20-W3015
			1500lm	4000K	black	black	RAT20-B4015
30°	1400lm	2700K	black	white	RAT20-W2730		
	1450lm	3000K	black	black	RAT20-B3030		
	1500lm	4000K	black	white	RAT20-W4030		
45°	1400lm	2700K	black	black	RAT20-B2745		
	1450lm	3000K	black	white	RAT20-W3045		
	1500lm	4000K	black	black	RAT20-B4045		

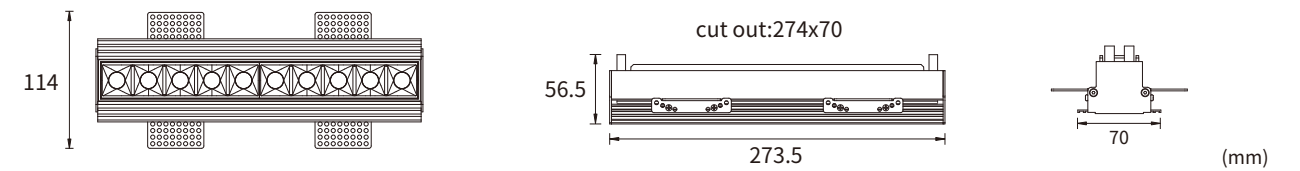

Filter

- Frosted (standard)
- Clear
- Vertical (optional)
- Woven

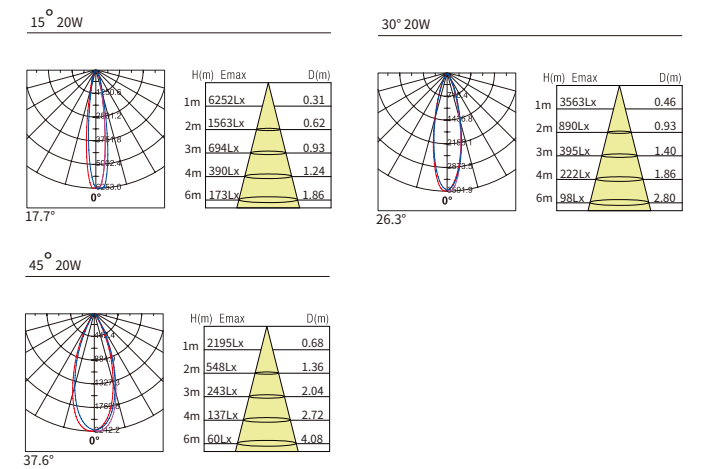

LED & Driver

Osram smd3030:  
Power: 3-5W/LED  
Voltage: 3V  
SDCM<3  
Driver:  
Input Voltage:100-277VAC  
/220-240VAC  
Output Current:600mA  
Output Voltage:DC25-42V



G.W.:15.95kgs  
Packaging:42x31x34cm,20PCS/CTN







# Raster wall washer

Change the optics RASTER is available in wall washer.  
 Perfect light out-put, clear and uniform.  
 Anti glare and visual comfort.

LED Type: OSRAM IP23 ●○ Black or white as standard

Power	CRI	Beam Angle	Luminous Flux	CCT	Refractive screen	Frame	Model Number
10W	>90	wall washer	700lm	2700K	black	white	RAW10-W27
			725lm	3000K	black	black	RAW10-B30
			750lm	4000K	black	white	RAW10-W40
20W	>90	wall washer	1400lm	2700K	black	black	RAW20-B27
			1450lm	3000K	black	white	RAW20-W30
			1500lm	4000K	black	black	RAW20-B40
30W	>90	wall washer	2100lm	2700K	black	white	RAW30-W27
			2175lm	3000K	black	black	RAW30-B30
			2250lm	4000K	black	white	RAW30-W40

## Raster wall washer

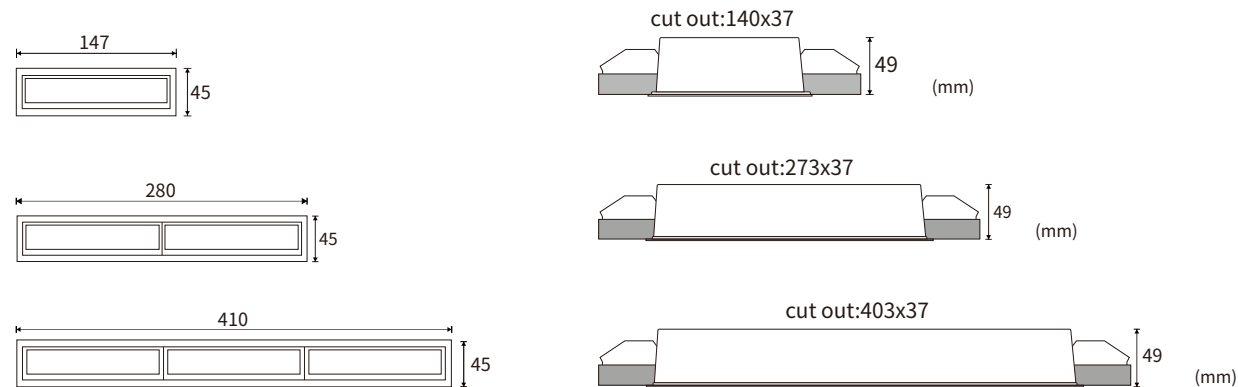
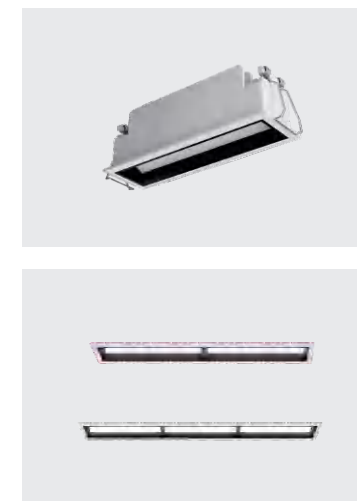

### LED & Driver

Osram smd3030:  
 Power: 3-5W/LED  
 Voltage: 3V  
 SDCM<3  
 Driver:  
 Input Voltage:100-277VAC  
 /220-240VAC  
 Output Current:600mA  
 Output Voltage:DC25-42V



wall washer 10W

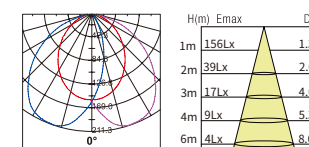

G.W.:14.50kgs  
 Packaging:35x32x28cm,30PCS/CTN



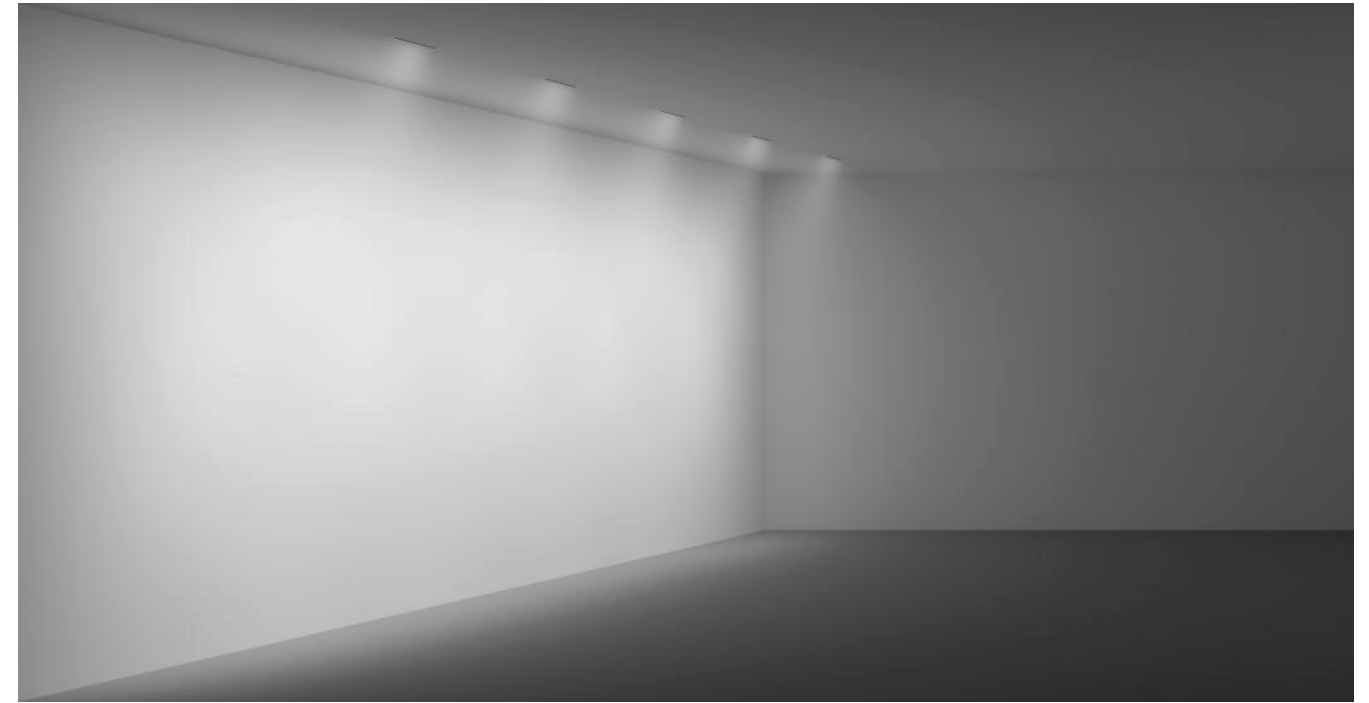

Wall washing  
 For uniform vertical illuminance,  
 the distance  $a$  of the luminaire  
 from the wall should be around one  
 third of the room height ( $h$ ).  
 Optimal wall offset and luminaire  
 spacing values are indicated in the  
 wall washer tables on the product  
 data sheets.  
 Rough guide:  $a = 1/3 \times h$

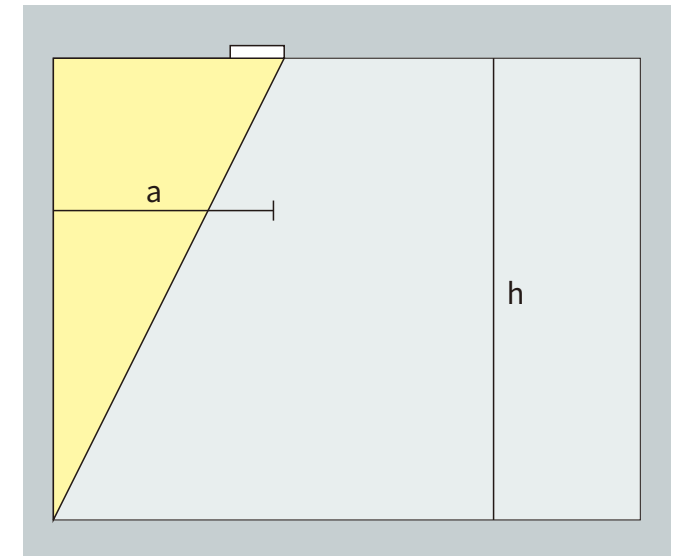

For good longitudinal uniformity, the  
 spacing ( $d$ ) of Compar lens wall washers  
 may be up to 1.3 times the offset from  
 the wall ( $a$ ).  
 Arrangement:  $d \leq 1.3 \times a$

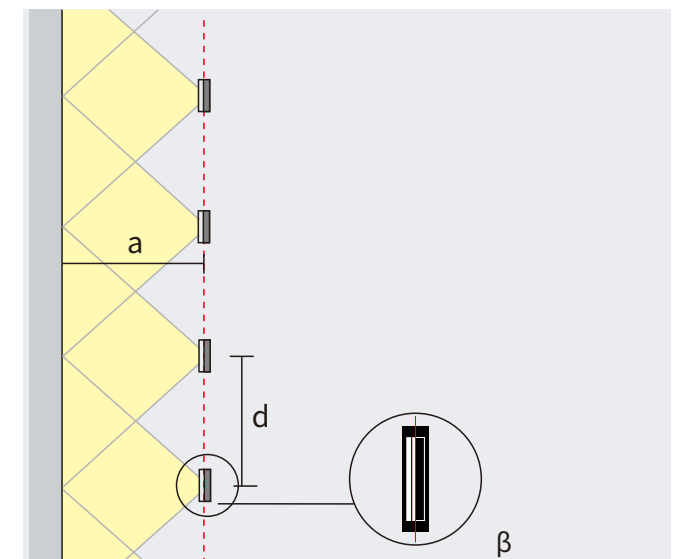

Please make sure install all luminaire in same direction which its keep  $\beta$  parallel with the wall.

LINEAR DOWNLIGHT | WALL WASHER

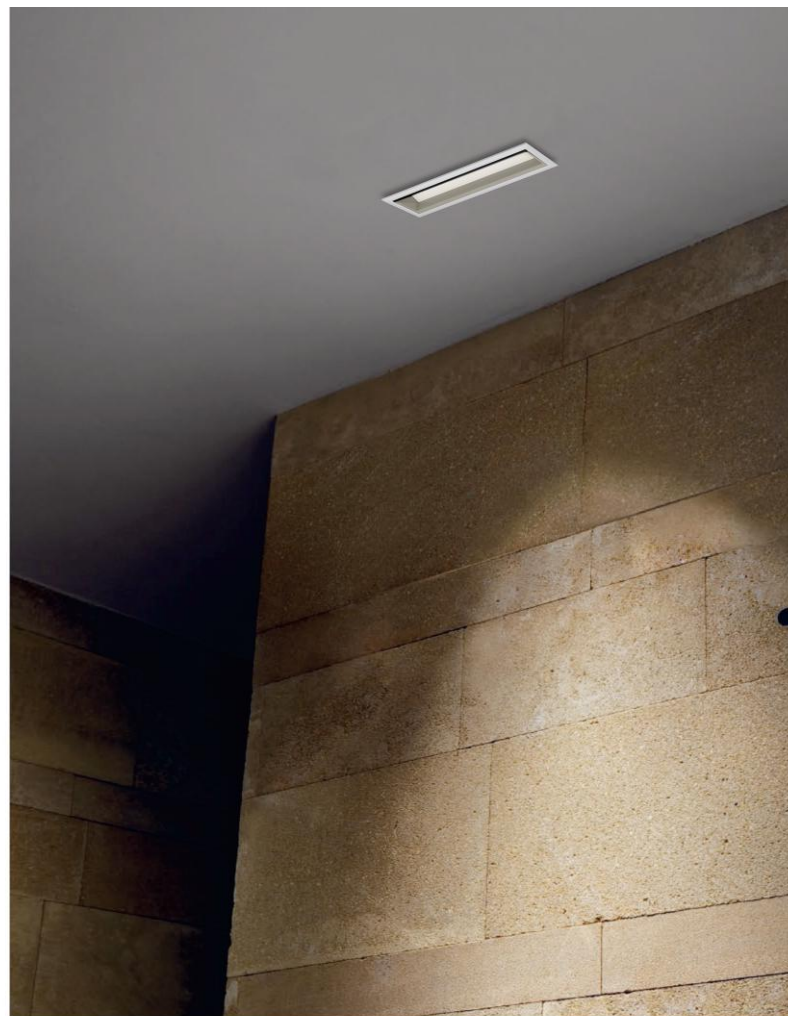



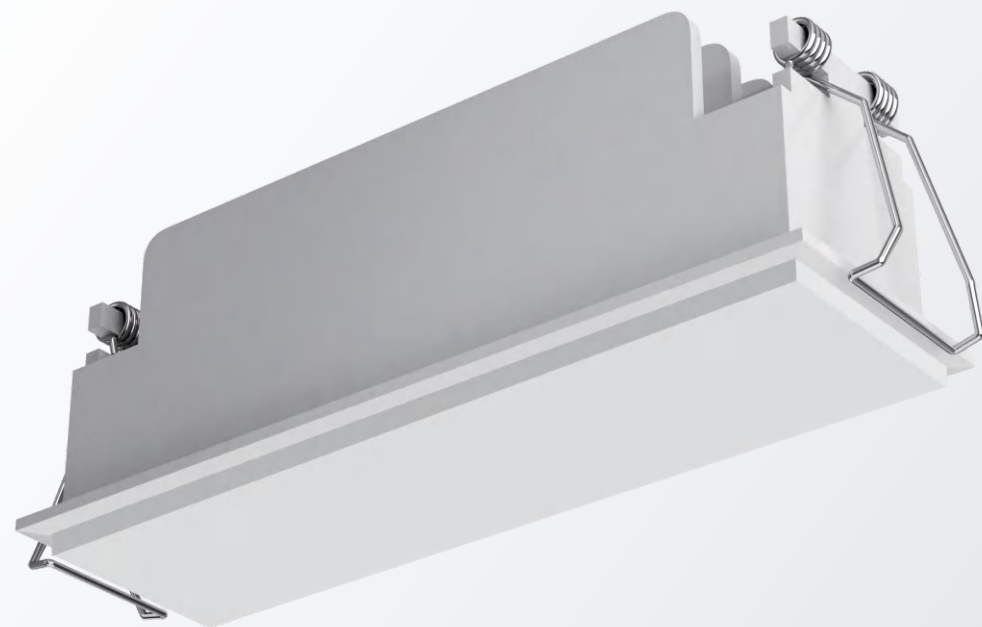

# Rasteracrylic

Change the optics RASTER is available in general lighting.  
Perfect light out-put, more brightness.

LED Type: OSRAM IP23 ●○ Black or white as standard

Power	CRI	Beam Angle	Luminous Flux	CCT	Refractive screen	Frame	Model Number
10W	>80	120°	800lm	2700K	black	white	RA10A-W27
			825lm	3000K	black	black	RA10A-B30
			850lm	4000K	black	white	RA10A-W40
20W	>80	120°	1600lm	2700K	black	black	RA20A-B27
			1650lm	3000K	black	white	RA20A-W30
			1700lm	4000K	black	black	RA20A-B40

## Raster acrylic

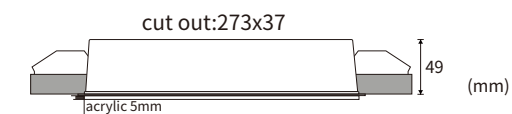
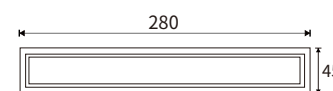
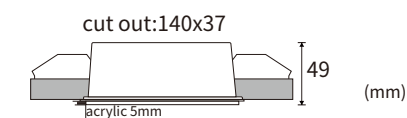
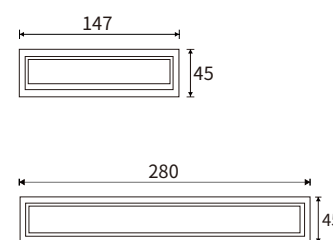
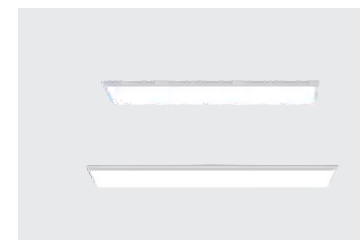
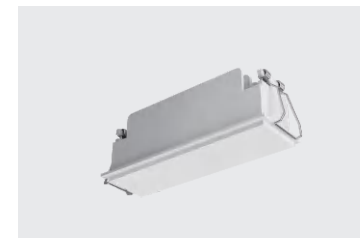

### LED & Driver

Epistar SMD2835:  
Power: 0.2W/LED  
Voltage: 3V  
SDCM<3  
Driver:  
Input Voltage:100-277VAC  
/220-240VAC  
Output Current:550mA



### acrylic 10W

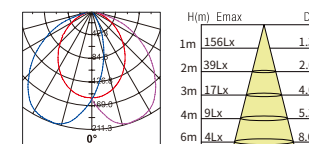

G.W.:12.50kgs  
Packaging:35x36x42cm,20PCS/CTN



## Raster General

LED Type: OSRAM IP23 ●○ Black or white as standard

Power	CRI	Beam Angle	Luminous Flux	CCT	Refractive screen	Frame	Model Number
10W	>90	100°	700lm	2700K	black	white	RAG10-W27
			725lm	3000K	black	black	RAG10-B30
			750lm	4000K	black	white	RAG10-W40

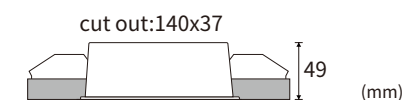
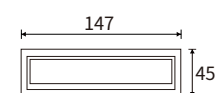
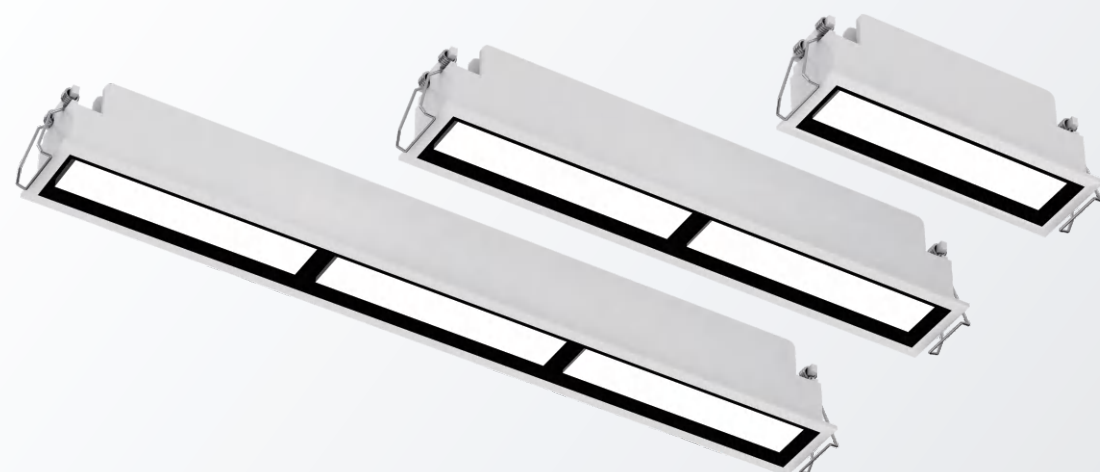

# Raster General

Change the optics RASTER is available in diffuser.  
Application in general lightings.

### LED & Driver

Osram smd3030:  
Power: 3-5W/LED  
Voltage: 3V  
SDCM<3  
Driver:  
Input Voltage:100-277VAC  
/220-240VAC  
Output Current:600mA  
Output Voltage:DC25-42V



diffuser 10W

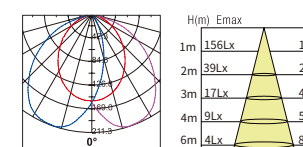

G.W.:14.50kgs  
Packaging:35x32x28cm,30PCS/CTN





LED Type: OSRAM IP23  Black or white as standard **Raster General**

Power	CRI	Beam Angle	Luminous Flux	CCT	Refractive screen	Frame	Model Number
20W	>90	100°	1400lm	2700K	black	white	RAG20-W27
			1450lm	3000K	black	black	RAG20-B30
			1500lm	4000K	black	white	RAG20-W40

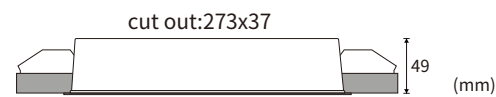
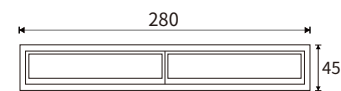

**LED & Driver**

Osram smd3030:  
 Power: 3-5W/LED  
 Voltage: 3V  
 SDCM<3  
 Driver:  
 Input Voltage:100-277VAC  
 /220-240VAC  
 Output Current:600mA  
 Output Voltage:DC25-36V



diffuser 20W

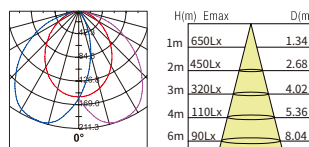

G.W.:12.30kgs  
 Packaging:32x32x36cm,20PCS/CTN



LED Type: OSRAM IP23  Black or white as standard **Raster General**

Power	CRI	Beam Angle	Luminous Flux	CCT	Refractive screen	Frame	Model Number
30W	>90	100°	2100lm	2700K	black	white	RAG30-W27
			2175lm	3000K	black	black	RAG30-B30
			2250lm	4000K	black	white	RAG30-W40

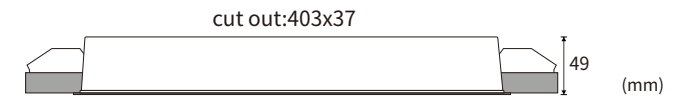
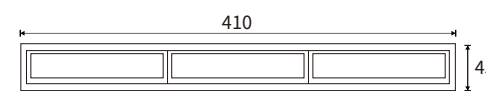
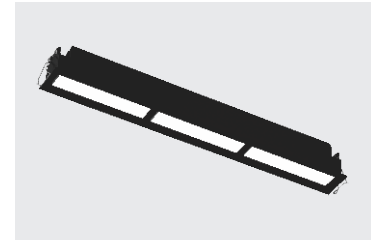
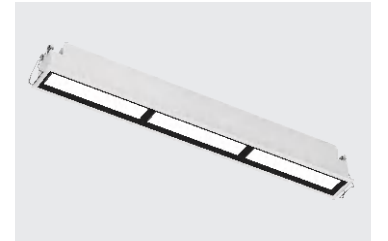

**LED & Driver**

Osram smd3030:  
 Power: 3-5W/LED  
 Voltage: 3V  
 SDCM<3  
 Driver:  
 Input Voltage:100-277VAC  
 /220-240VAC  
 Output Current:600mA  
 Output Voltage:DC20-50V



diffuser 30W

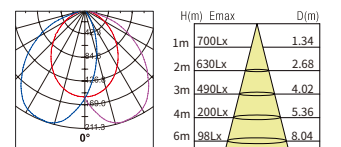

G.W.:14.5kgs  
 Packaging:42x20x42cm,50PCS/CTN



Raster adjustable



**Raster  
Adjustable**

| Adjustable Recessed Light



LED Type: OSRAM IP23 ●○ Black or white as standard  
**Raster adjustable**

Power	CRI	Beam Angle	Luminous Flux	CCT	Refractive screen	Frame	Model Number
2W	>90	15°	140lm	2700K	black	black	RAD02-B2715
			145lm	3000K	black	white	RAD02-W3015
			150lm	4000K	black	black	RAD02-B4015
		30°	140lm	2700K	black	white	RAD02-W2730
			145lm	3000K	black	black	RAD02-B3030
			150lm	4000K	black	white	RAD02-W4030
45°	140lm	2700K	black	black	RAD02-B2745		
	145lm	3000K	black	white	RAD02-W3045		
	150lm	4000K	black	black	RAD02-B4045		

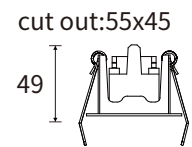
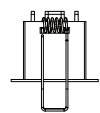
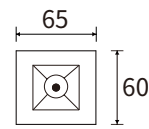

LED Type: OSRAM IP23 ●○ Black or white as standard  
**Raster adjustable**

Power	CRI	Beam Angle	Luminous Flux	CCT	Refractive screen	Frame	Model Number
4W	>90	15°	280lm	2700K	black	black	RAD04-B2715
			290lm	3000K	black	white	RAD04-W3015
			300lm	4000K	black	black	RAD04-B4015
		30°	280lm	2700K	black	white	RAD04-W2730
			290lm	3000K	black	black	RAD04-B3030
			300lm	4000K	black	white	RAD04-W4030
45°	280lm	2700K	black	black	RAD04-B2745		
	290lm	3000K	black	white	RAD04-W3045		
	300lm	4000K	black	black	RAD04-B4045		

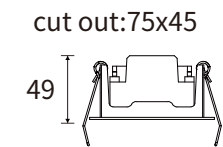
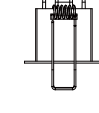
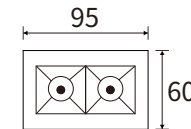

**Filter**

- Frosted (standard)
- Clear
- Vertical (optional)
- Woven

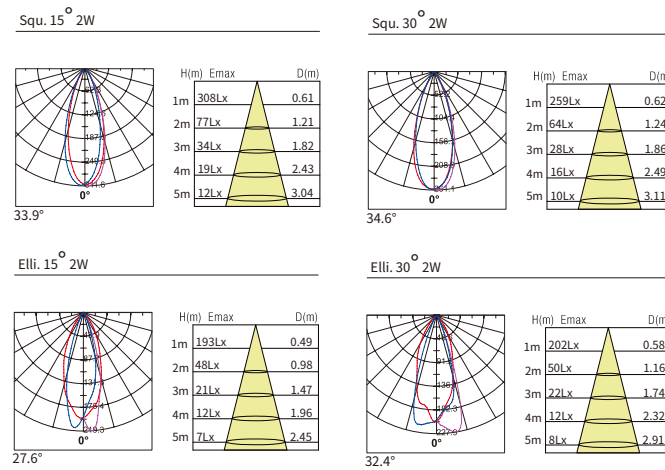

**LED & Driver**

Osram smd3030:  
 Power: 3-5W/LED  
 Voltage: 3V  
 SDCM<3  
 Driver:  
 Input Voltage:100-277VAC /220-240VAC  
 Output Current:700mA  
 Output Voltage:DC3-8V



G.W.:11.80kgs  
 Packaging:39x25x45cm,50PCS/CTN



**Filter**

- Frosted (standard)
- Clear
- Vertical (optional)
- Woven

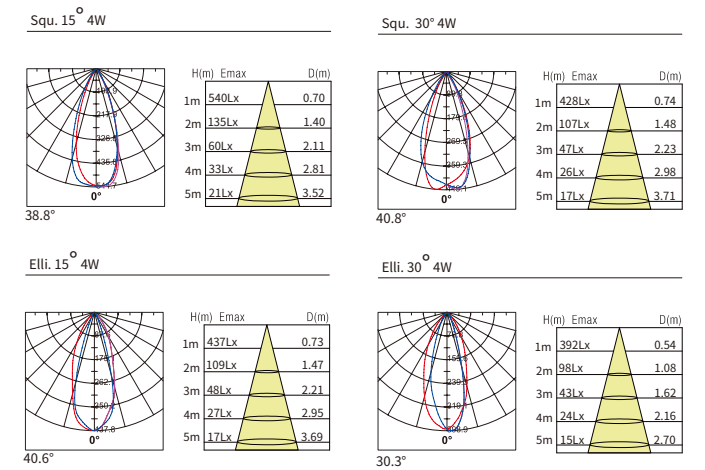

**LED & Driver**

Osram smd3030:  
 Power: 3-5W/LED  
 Voltage: 3V  
 SDCM<3  
 Driver:  
 Input Voltage:100-277VAC /220-240VAC  
 Output Current:700mA  
 Output Voltage:DC3-8V



G.W.:14.70kgs  
 Packaging:39x25x45cm,50PCS/CTN



LED Type: OSRAM IP23 ●○ Black or white as standard  
**Raster adjustable**

Power	CRI	Beam Angle	Luminous Flux	CCT	Refractive screen	Frame	Model Number
10W	>90	10°	700lm	2700K	black	white	RAD10-W2710
			725lm	3000K	black	black	RAD10-B3010
			750lm	4000K	black	white	RAD10-W4010
		15°	700lm	2700K	black	black	RAD10-B2715
			725lm	3000K	black	white	RAD10-W3015
			750lm	4000K	black	black	RAD10-B4015
		30°	700lm	2700K	black	white	RAD10-W2730
			725lm	3000K	black	black	RAD10-B3030
			750lm	4000K	black	white	RAD10-W4030
		45°	700lm	2700K	black	black	RAD10-B2745
			725lm	3000K	black	white	RAD10-W3045
			750lm	4000K	black	black	RAD10-B4045

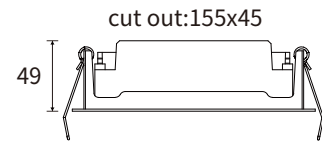
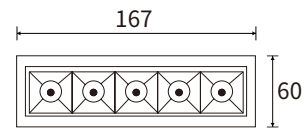
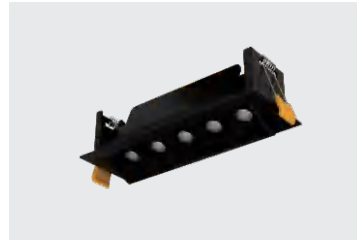

LED Type: OSRAM IP23 ●○ Black or white as standard  
**Raster adjustable**

Power	CRI	Beam Angle	Luminous Flux	CCT	Refractive screen	Frame	Model Number
20W	>90	10°	1400lm	2700K	black	white	RAD20-W2710
			1450lm	3000K	black	black	RAD20-B3010
			1500lm	4000K	black	white	RAD20-W4010
		15°	1400lm	2700K	black	black	RAD20-B2715
			1450lm	3000K	black	white	RAD20-W3015
			1500lm	4000K	black	black	RAD20-B4015
		30°	1400lm	2700K	black	white	RAD20-W2730
			1450lm	3000K	black	black	RAD20-B3030
			1500lm	4000K	black	white	RAD20-W4030
		45°	1400lm	2700K	black	black	RAD20-B2745
			1450lm	3000K	black	white	RAD20-W3045
			1500lm	4000K	black	black	RAD20-B4045

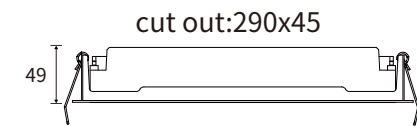
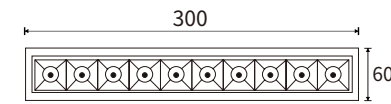

**Filter**

- Frosted (standard)
- Clear (optional)
- Vertical (optional)
- Woven (optional)

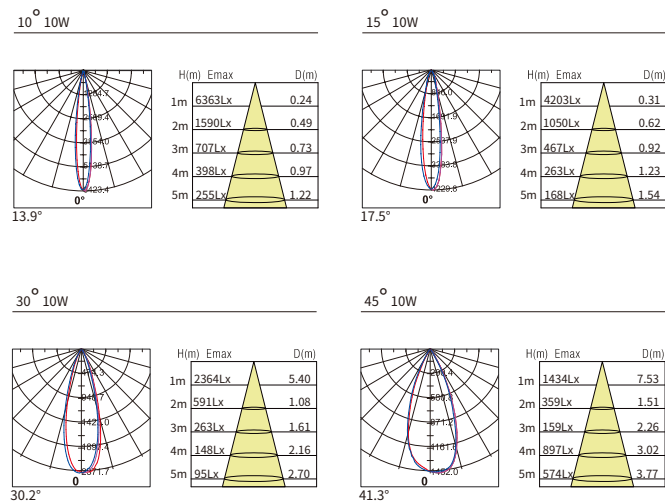

**LED & Driver**

Osram smd3030:  
 Power: 3-5W/LED  
 Voltage: 3V  
 SDCM<3  
 Driver:  
 Input Voltage:100-277VAC  
 /220-240VAC  
 Output Current:550mA  
 Output Voltage:DC8-20V



G.W.:14.52kgs  
 Packaging:39x38x27cm,30PCS/CTN



**Filter**

- Frosted (standard)
- Clear (optional)
- Vertical (optional)
- Woven (optional)

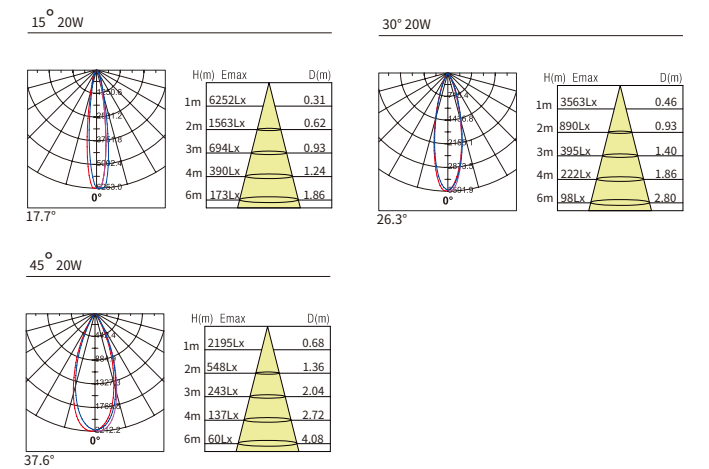

**LED & Driver**

Osram smd3030:  
 Power: 3-5W/LED  
 Voltage: 3V  
 SDCM<3  
 Driver:  
 Input Voltage:100-277VAC  
 /220-240VAC  
 Output Current:600mA  
 Output Voltage:DC25-42V



G.W.:16.10kgs  
 Packaging:39x34x36cm,20PCS/CTN





Raster adjustable



●○ Black or white as standard

Power	CRI	Beam Angle	Luminous Flux	CCT	Refractive screen	Frame	Model Number
30W	>90	10°	2100lm	2700K	black	white	RAD30-W2710
			2175lm	3000K	black	black	RAD30-B3010
			2250lm	4000K	black	white	RAD30-W4010
		15°	2100lm	2700K	black	black	RAD30-B2715
			2175lm	3000K	black	white	RAD30-W3015
			2250lm	4000K	black	black	RAD30-B4015
30°	2100lm	2700K	black	white	RAD30-W2730		
	2175lm	3000K	black	black	RAD30-B3030		
	2250lm	4000K	black	white	RAD30-W4030		
45°	2100lm	2700K	black	black	RAD30-B2745		
	2175lm	3000K	black	white	RAD30-W3045		
	2250lm	4000K	black	black	RAD30-B4045		

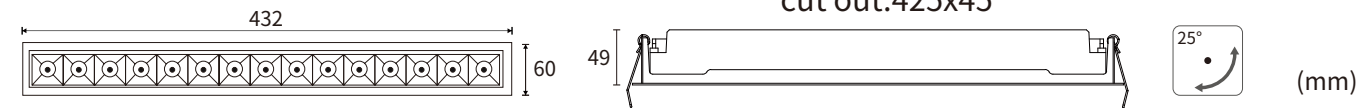
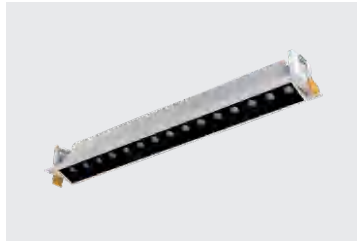

Filter

- Frosted (standard)
- Clear
- Vertical (optional)
- Woven

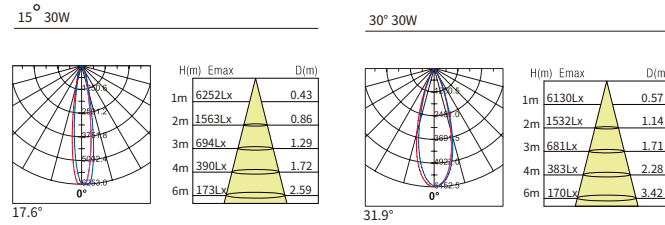

LED & Driver

Osram smd3030:  
 Power: 3-5W/LED  
 Voltage: 3V  
 SDCM<3  
 Driver:  
 Input Voltage:100-277VAC  
 /220-240VAC  
 Output Current:600mA  
 Output Voltage:DC20-50V



G.W.:11.53kgs  
 Packaging:47x39x19cm,10PCS/CTN



LED Type: OSRAM IP23 ●○ Black or white as standard **Raster plus**

Power	CRI	Beam Angle	Luminous Flux	CCT	Body	Frame	Model Number
20W	>90	10°	1400lm	2700K	black	white	RAPL201-W2710
			1450lm	3000K	black	black	RAPL201-B3010
			1500lm	4000K	black	white	RAPL201-W4010
		15°	1400lm	2700K	black	black	RAPL201-B2715
			1450lm	3000K	black	white	RAPL201-W3015
			1500lm	4000K	black	black	RAPL201-B4015
		30°	1400lm	2700K	black	white	RAPL201-W2730
			1450lm	3000K	black	black	RAPL201-B3030
			1500lm	4000K	black	white	RAPL201-W4030
		45°	1400lm	2700K	black	black	RAPL201-B2745
			1450lm	3000K	black	white	RAPL201-W3045
			1500lm	4000K	black	black	RAPL201-B4045

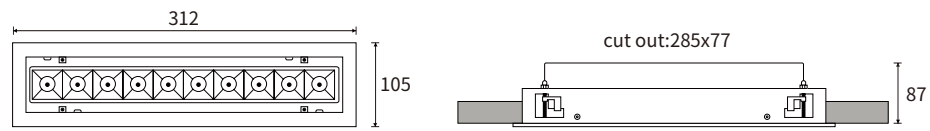

Filter

- Frosted (standard)
- Clear
- Vertical (optional)
- Woven

LED & Driver

Osram smd3030:  
 Power: 3-5W/LED  
 Voltage: 3V  
 SDCM<3  
 Driver:  
 Input Voltage:100-277VAC /220-240VAC  
 Output Current:600mA  
 Output Voltage:DC25-42V



G.W.:11.10kgs  
 Packaging:37x48x34cm,8PCS/CTN



LED Type: OSRAM IP23 ●○ Black or white as standard **Raster plus**

Power	CRI	Beam Angle	Luminous Flux	CCT	Body	Frame	Model Number
30W	>90	10°	2100lm	2700K	black	white	RAPL301-W2710
			2150lm	3000K	black	black	RAPL301-W3010
			2250lm	4000K	black	white	RAPL301-W4010
		15°	2100lm	2700K	black	black	RAPL301-W2715
			2150lm	3000K	black	white	RAPL301-W3015
			2250lm	4000K	black	black	RAPL301-W4015
		30°	2100lm	2700K	black	white	RAPL301-W2730
			2150lm	3000K	black	black	RAPL301-W3030
			2200lm	4000K	black	white	RAPL301-W4030
		45°	2100lm	2700K	black	black	RAPL301-W2745
			2150lm	3000K	black	white	RAPL301-W3045
			2200lm	4000K	black	black	RAPL301-W4045

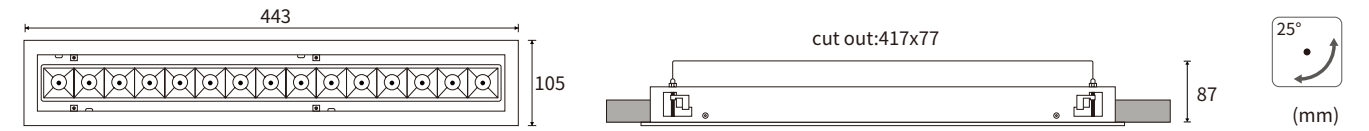

Filter

- Frosted (standard)
- Clear
- Vertical (optional)
- Woven

LED & Driver

Osram smd3030:  
 Power: 3-5W/LED  
 Voltage: 3V  
 SDCM<3  
 Driver:  
 Input Voltage:100-277VAC /220-240VAC  
 Output Current:600mA  
 Output Voltage:DC20-50V



G.W.:14.94kgs  
 Packaging:37x48x47cm,8PCS/CTN





LED Type: OSRAM IP23 ●○ Black or white as standard **Raster plus**

Power	CRI	Beam Angle	Luminous Flux	CCT	Body	Frame	Model Number
2x20W	>90	10°	2800lm	2700K	black	white	RAPL202-W2710
			2850lm	3000K	black	black	RAPL202-W3010
			3000lm	4000K	black	white	RAPL202-W4010
		15°	2800lm	2700K	black	black	RAPL202-W2715
			2850lm	3000K	black	white	RAPL202-W3015
			3000lm	4000K	black	black	RAPL202-W4015
		30°	2800lm	2700K	black	white	RAPL202-W2730
			2850lm	3000K	black	black	RAPL202-W3030
			3000lm	4000K	black	white	RAPL202-W4030
45°	2800lm	2700K	black	black	RAPL202-W2745		
	2850lm	3000K	black	white	RAPL202-W3045		
	3000lm	4000K	black	black	RAPL202-W4045		

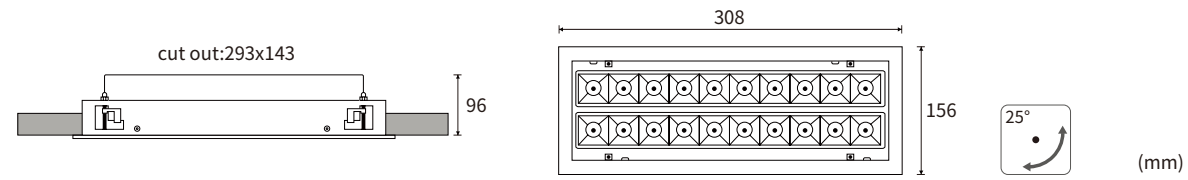

- Filter**
- Frosted (standard)
  - Clear
  - Vertical
  - Woven
- (optional)

**LED & Driver**  
 Osram smd3030:  
 Power: 3-5W/LED  
 Voltage: 3V  
 SDCM<  
 Driver:  
 Input Voltage:100-277VAC /220-240VAC  
 Output Current:600mA  
 Output Voltage:DC25-42V

G.W.:11.10kgs  
 Packaging:37x48x34cm,4PCS/CTN



LED Type: OSRAM IP23 ●○ Black or white as standard **Raster plus**

Power	CRI	Beam Angle	Luminous Flux	CCT	Body	Frame	Model Number
2x30W	>90	10°	4200lm	2700K	black	white	RAPL303-W2710
			4250lm	3000K	black	black	RAPL303-W3010
			4500lm	4000K	black	white	RAPL303-W4010
			4200lm	2700K	black	black	RAPL303-W2715
			4250lm	3000K	black	white	RAPL303-W3015
			4500lm	4000K	black	black	RAPL303-W4015
		15°	4200lm	2700K	black	white	RAPL303-W2730
			4250lm	3000K	black	black	RAPL303-W3030
			4500lm	4000K	black	white	RAPL303-W4030
			4200lm	2700K	black	black	RAPL303-W2745
			4250lm	3000K	black	white	RAPL303-W3045
			4500lm	4000K	black	black	RAPL303-W4045

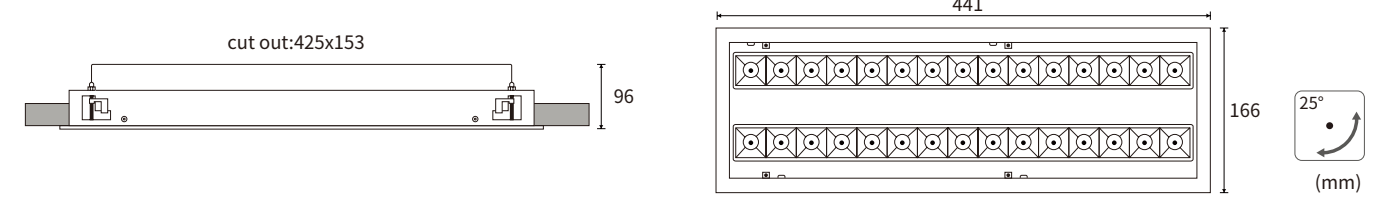

- Filter**
- Frosted (standard)
  - Clear
  - Vertical
  - Woven
- (optional)

**LED & Driver**  
 Osram smd3030:  
 Power: 3-5W/LED  
 Voltage: 3V  
 SDCM<3  
 Driver:  
 Input Voltage:100-277VAC /220-240VAC  
 Output Current:600mA  
 Output Voltage:DC20-50V

G.W.:14.94kgs  
 Packaging:37x48x47cm,4PCS/CTN





# Rasterpro

1, 2 or 3 lamps combination available for Raster pro series.  
 Visual installation and performing UGR<19.  
 Anti-glare, matt frosted and spread optical accessories  
 are available to match different applications.

LED Type: OSRAM IP23 ●○ Black or white as standard

Power	CRI	Beam Angle	Luminous Flux	CCT	Refractive screen	Frame	Model Number
10W	>90	15°	800lm	2700K	black	black	RAP10-B2715
			800lm	3000K	black	white	RAP10-W3015
			850lm	4000K	black	black	RAP10-B4015
		30°	800lm	2700K	black	white	RAP10-W2730
			800lm	3000K	black	black	RAP10-B3030
			850lm	4000K	black	white	RAP10-W4030
45°	800lm	2700K	black	black	RAP10-B2745		
	800lm	3000K	black	white	RAP10-W3045		
	850lm	4000K	black	black	RAP10-B4045		

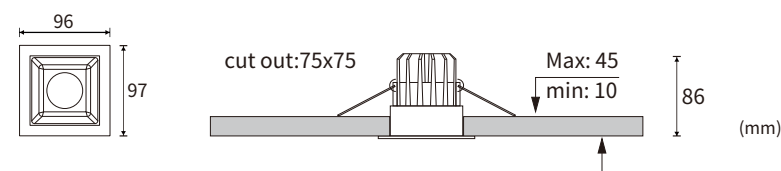
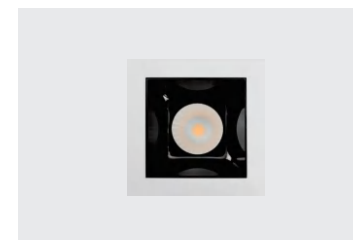

## LED & Driver

CREE COB:  
 Power: 10W/LED  
 Voltage: 36V  
 SDCM<3  
 Driver:  
 Input Voltage:100-277VAC  
 /220-240VAC  
 Output Current:250mA  
 Output Voltage:DC24-42V



15° 10W

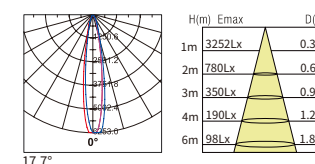

30° 10W

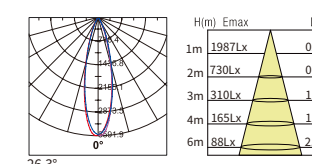

45° 10W

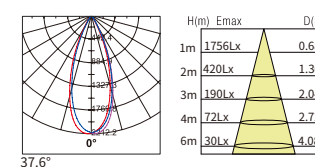

G.W.:11.82kgs  
 Packaging:52x32x20cm,30PCS/CTN







LED Type: OSRAM IP23 ●○ Black or white as standard

### Raster pro

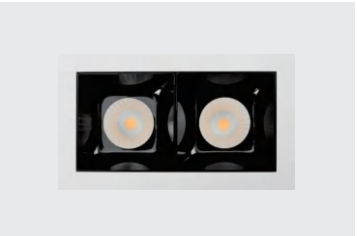
Power	CRI	Beam Angle	Luminous Flux	CCT	Refractive screen	Frame	Model Number
20W	>90	15°	1600lm	2700K	black	black	RAP20-B2715
			1600lm	3000K	black	white	RAP20-W3015
			1650lm	4000K	black	black	RAP20-B4015
		30°	1600lm	2700K	black	white	RAP20-W2730
			1600lm	3000K	black	black	RAP20-B3030
			1650lm	4000K	black	white	RAP20-W4030
45°	1600lm	2700K	black	black	RAP20-B2745		
	1600lm	3000K	black	white	RAP20-W3045		
	1650lm	4000K	black	black	RAP20-B4045		

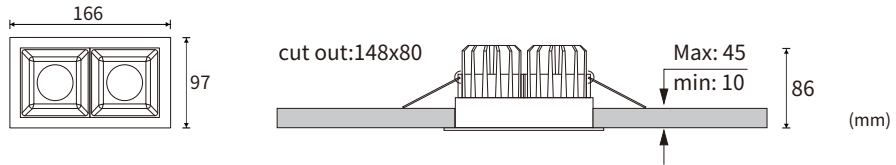





LED & Driver

CREE COB:  
 Power: 20W/LED  
 Voltage: 36V  
 SDCM<3  
 Driver:  
 Input Voltage:100-277VAC /220-240VAC  
 Output Current:250mA  
 Output Voltage:DC24-42V

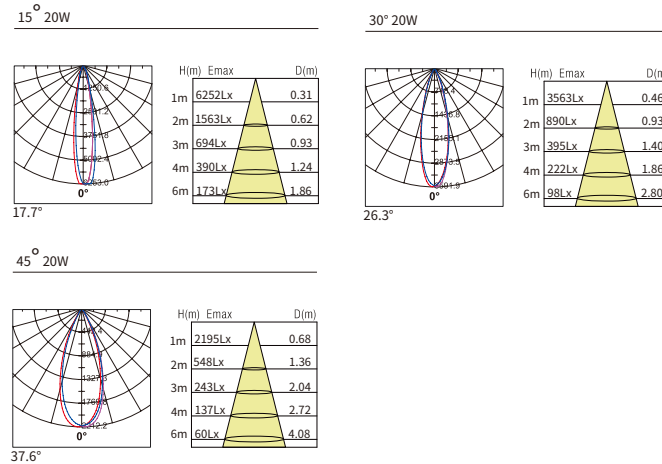



G.W.:15.60kgs  
 Packaging:52x36x20cm,20PCS/CTN



LED Type: OSRAM IP23 ●○ Black or white as standard

### Raster pro

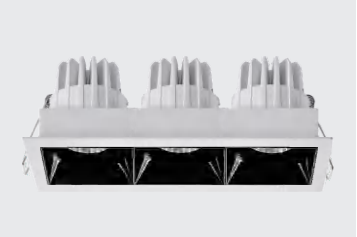
Power	CRI	Beam Angle	Luminous Flux	CCT	Refractive screen	Frame	Model Number
30W	>90	15°	2400lm	2700K	black	black	RAP30-B2715
			2400lm	3000K	black	white	RAP30-W3015
			2450lm	4000K	black	black	RAP30-B4015
		30°	2400lm	2700K	black	white	RAP30-W2730
			2400lm	3000K	black	black	RAP30-B3030
			2450lm	4000K	black	white	RAP30-W4030
45°	2400lm	2700K	black	black	RAP30-B2745		
	2400lm	3000K	black	white	RAP30-W3045		
	2450lm	4000K	black	black	RAP30-B4045		

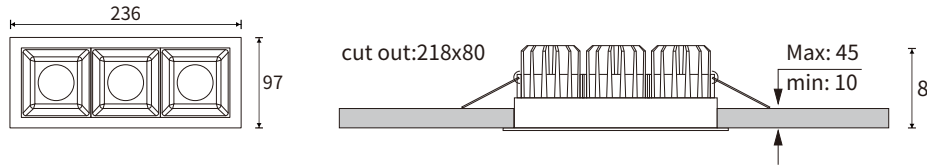





LED & Driver

CREE COB:  
 Power: 30W/LED  
 Voltage: 36V  
 SDCM<3  
 Driver:  
 Input Voltage:100-277VAC /220-240VAC  
 Output Current:250mA  
 Output Voltage:DC24-42V

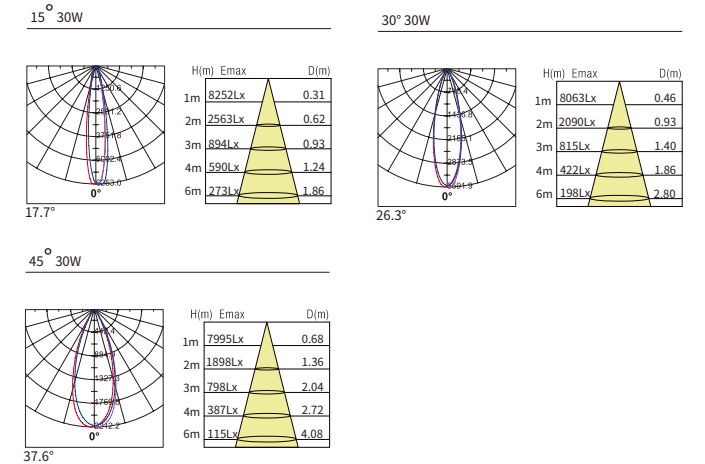

G.W.:16.20kgs  
 Packaging:52x26x32cm,15PCS/CTN





# Raster pendant

Raster pendant is a new version in Raster family.  
Further will be more options.

LED Type: CREE IP20  White color as standard

Power	CRI	Beam Angle	Luminous Flux	CCT	Housing	Model Number
5W	>80	13°	400lm	2700K	white	RAP05-W2713
			450lm	3000K	black	RAP05-B3013
			480lm	4000K	white	RAP05-W4013
		36°	400lm	2700K	black	RAP05-B2736
			450lm	3000K	white	RAP05-W3036
			480lm	4000K	white	RAP05-W4036
		46°	400lm	2700K	white	RAP05-W2746
			450lm	3000K	white	RAP05-W3046
			480lm	4000K	black	RAP05-B4046

## Raster pendent

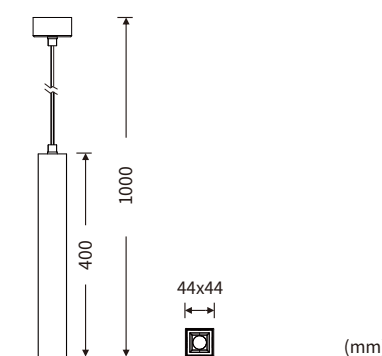

### LED & Driver

CREE COB:  
Power: 5W/LED  
Voltage: 18V  
SDCM<3  
LIFUD driver:  
Input voltage:100-240VAC  
/220-240V/110-130V  
Output current: 150mA  
Output voltage:DC12-24V



### 36° 5W

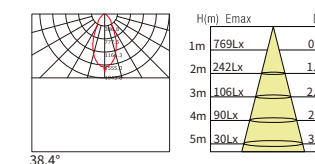





Direct X

LED Type: Bridgelux IP20 White as standard

Power	CRI	Beam Angle	Luminous Flux	CCT	Refractive screen	Frame	Model Number
33W	>90	15°/ wallwasher	2300lm	2700K	ww+15+ww	balck	DIX33-B27W15W
			2300lm	3000K	15+15+15	balck	DIX33-B3015
			2300lm	4000K	15+ww+ww	balck	DIX33-B4015WW
			2300lm	2700K	ww+15+ww	white	DIX33-W27W15W
			2300lm	3000K	15+15+15	white	DIX33-W3015
			2300lm	4000K	15+ww+ww	white	DIX33-W4015WW

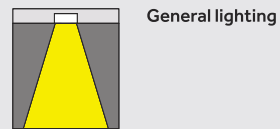

General lighting

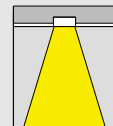

**Downlights**  
Wide beam, rotationally symmetrical light distribution for general lighting

**LED module**  
33W  
2000lm - 2500 lm  
Light distribution: Wide flood

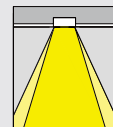

**Downlights oval flood**  
Axially symmetrical light distribution for linear lighting.

**LED module**  
33W  
2000lm - 2500 lm  
Light distribution: Oval flood

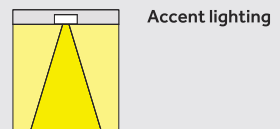

Accent lighting

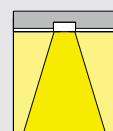

**Double wallwashers+General lighting**  
Axially symmetrical light distribution for illumination of parallel walls in corridors and hallways, with downwards-directed light for the general illumination

**LED module**  
33W  
1500lm - 2000 lm  
Light distribution: Wallwash+Wide flood

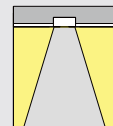

With wireless intelligent control driver, individual controllable, double wallwashers

**LED module**  
22W  
1000lm - 1200 lm  
Light distribution: Wallwash

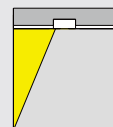

With wireless intelligent control driver, individual controllable, one-side wallwasher

**LED module**  
11W  
500lm - 700 lm  
Light distribution: Wallwash

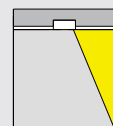

With wireless intelligent control driver, individual controllable, one-side wallwasher

**LED module**  
11W  
500lm - 700 lm  
Light distribution: Wallwash

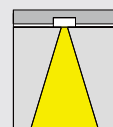

With wireless intelligent control driver, individual controllable, downwards-directed light for general lighting

**LED module**  
11W  
500lm - 700 lm  
Light distribution: Wide flood

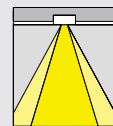

**LED module**  
11W  
500lm - 700 lm  
Light distribution: Oval wide flood

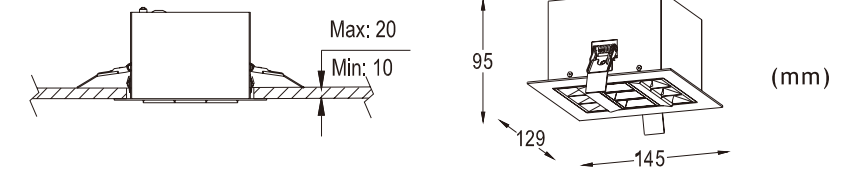

15° 33W

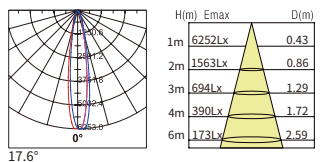

LED & Driver

Bridgelux 5050  
Power: 3-4W/LED  
Voltage: 36V  
SDCM<3  
TCI DALI Driver:  
Input voltage:100-240VAC  
/220-240V/110-130V  
Output current:300mA  
Output voltage:DC30-40V



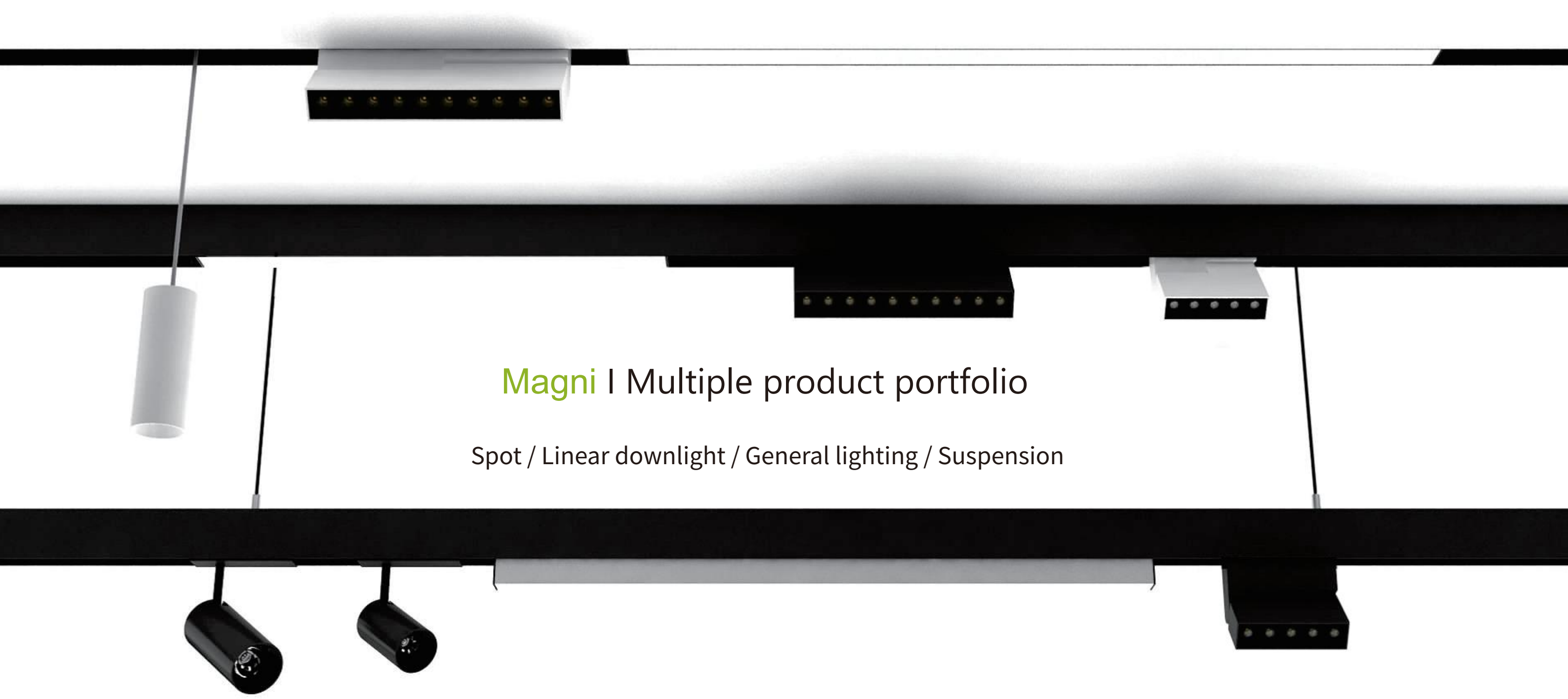

Magni | Multiple product portfolio

Spot / Linear downlight / General lighting / Suspension





## Dimmer

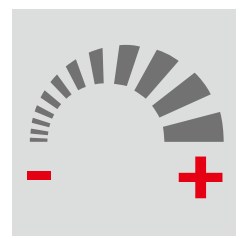

On-board electronic adjustment device for controlling and modulating the intensity of the lamp light flow.



## Adjustability

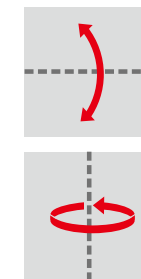

The spot/floodlights can rotate about the vertical axis and be angled relative to the horizontal plane. The degrees vary depending on the luminaire.

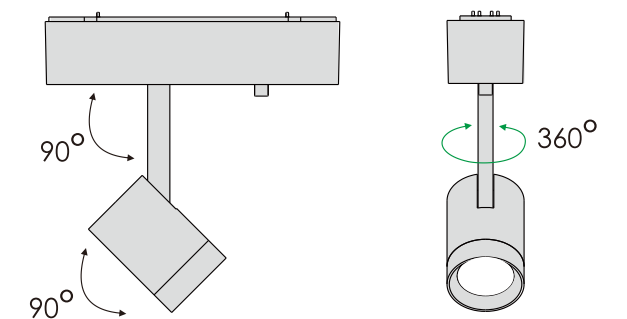

## Installation Notes

- Lamps are installed by magnetic adsorption mode, the magnetic installation end of lamps can not have foreign matter.
- If need to move the position of the lamps, please take it out, and then put it into the track again, adjust position, prohibit sliding adjusting in the track, in case of damaging track distribution structure parts.

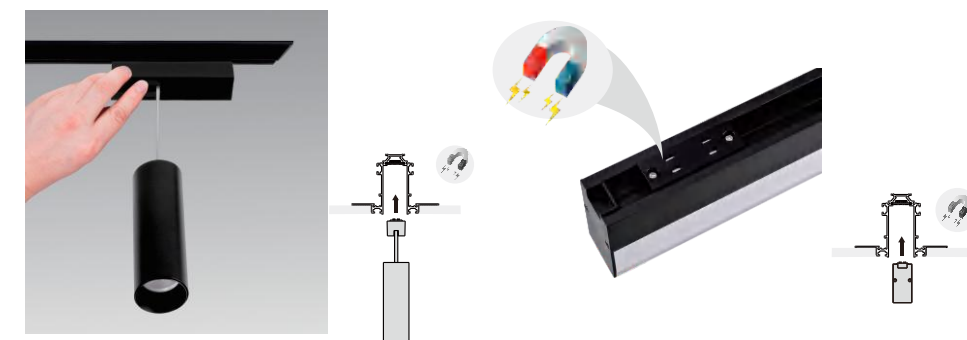

# MAGNETIC TRACK

RECESSED TRACK

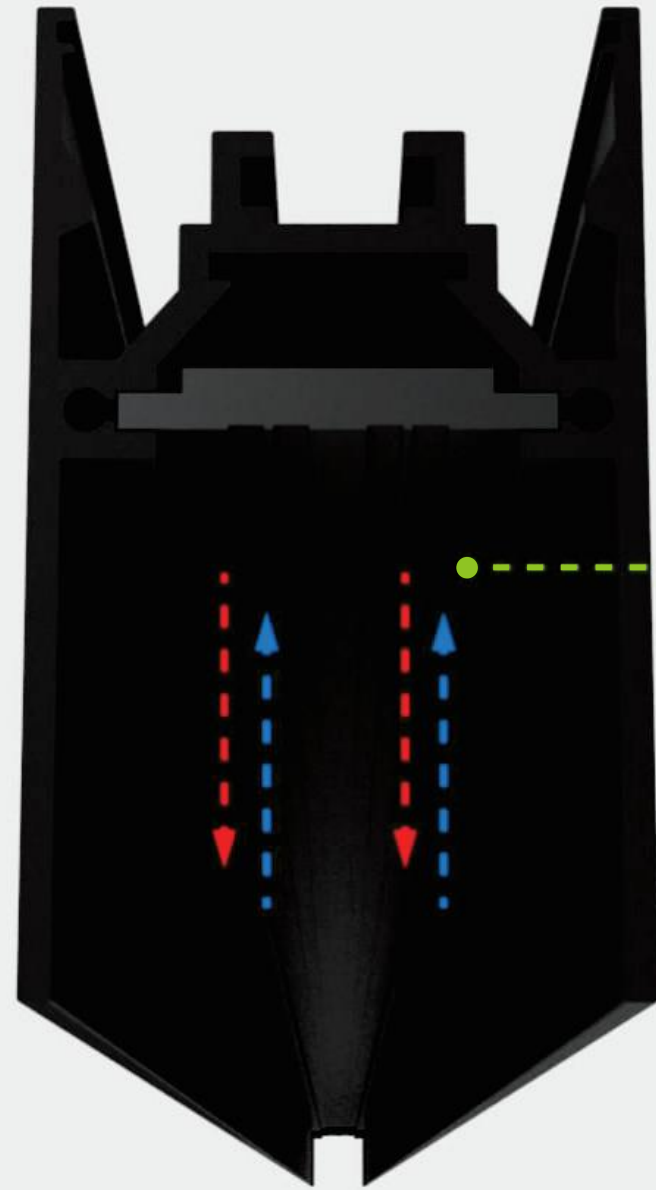
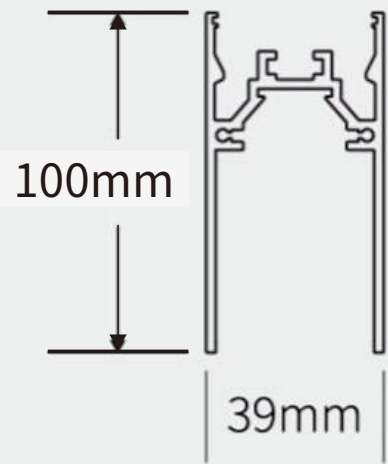

**Magnetic circuit**  
Regardless of the positive and negative poles



Max user weight pulling: 5KG







LED Type: CREE IP20 Black as standard **Magni Raster**

Power	CRI	Beam Angle	Luminous Flux	CCT	Diffuser	Housing	Model Number
7W	>90	15°	400lm	2700K	black	black	RARA07-B2715
			450lm	3000K	black	black	RARA07-B3015
			490lm	4000K	black	black	RARA07-B4015
		30°	400lm	2700K	black	black	RARA07-B2730
			450lm	3000K	black	black	RARA07-B3030
			490lm	4000K	black	black	RARA07-B4030
		45°	400lm	2700K	black	black	RARA07-B2745
			450lm	3000K	black	black	RARA07-B3045
			490lm	4000K	black	black	RARA07-B4545

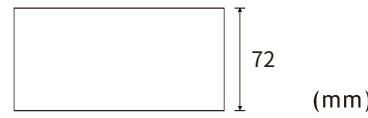

Optical Parameters

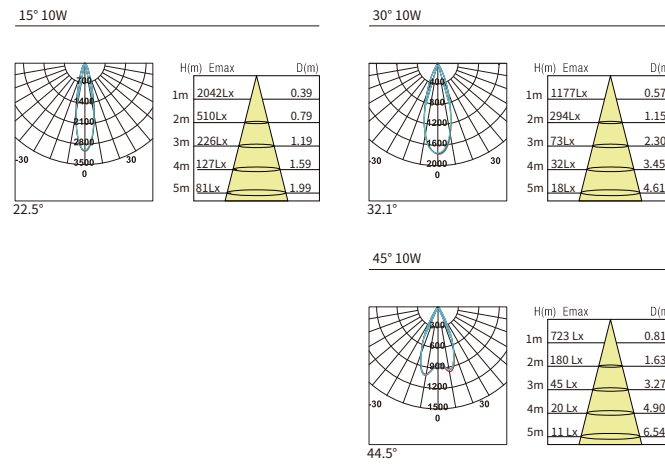
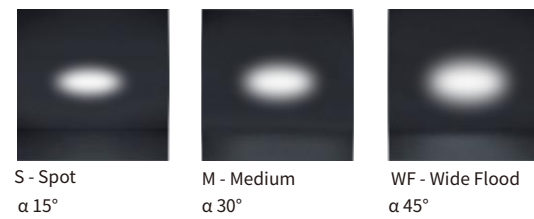

LED & Driver

CREE XPG2:  
Power: 1-3W/LED  
Voltage: 3V  
SDCM<3  
MEANWELL Driver:  
Input Voltage:85-265VAC  
/220-240V/110-130V  
Output Voltage:DC24V  
Power:100-350W



G.W.:25.50kgs  
Packaging:69x51x40cm,25PCS/CTN



LED Type: CREE IP20 Black as standard **Magni Raster**

Power	CRI	Beam Angle	Luminous Flux	CCT	Diffuser	Housing	Model Number
12W	>90	15°	840lm	2700K	black	black	RARA12-B2715
			900lm	3000K	black	black	RARA12-B3015
			920lm	4000K	black	black	RARA12-B4015
		30°	840lm	2700K	black	black	RARA12-B2730
			900lm	3000K	black	black	RARA12-B3030
			920lm	4000K	black	black	RARA12-B4030
		45°	840lm	2700K	black	black	RARA12-B2745
			900lm	3000K	black	black	RARA12-B3045
			920lm	4000K	black	black	RARA12-B4545

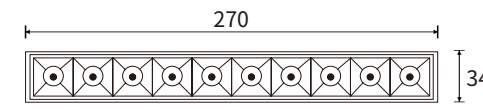

Optical Parameters

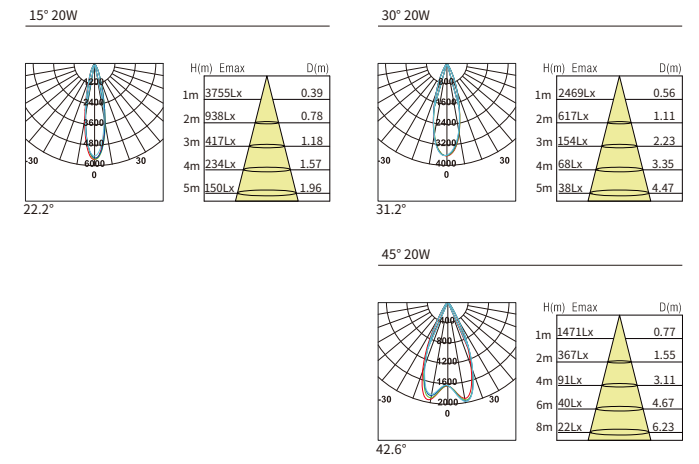
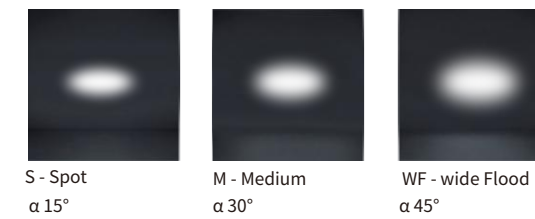

LED & Driver

CREE XPG2:  
Power: 1-3W/LED  
Voltage: 3V  
SDCM<3  
MEANWELL Driver:  
Input Voltage:85-265VAC  
/220-240V/110-130V  
Output Voltage:DC24V  
Power:100-350W



G.W.:25.50kgs  
Packaging:69x51x40cm,25PCS/CTN





## Magni Raster

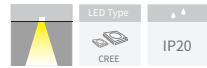

● Black as standard

Power	CRI	Beam Angle	Luminous Flux	CCT	Diffuser	Housing	Model Number
22W	>90	15°	1540lm	2700K	black	black	RARA22-B2715
			1600lm	3000K	black	black	RARA22-B3015
			1650lm	4000K	black	black	RARA22-B4015
		30°	1540lm	2700K	black	black	RARA22-B2730
			1600lm	3000K	black	black	RARA22-B3030
			1650lm	4000K	black	black	RARA22-B4030
		45°	1540lm	2700K	black	black	RARA22-B2745
			1600lm	3000K	black	black	RARA22-B3045
			1650lm	4000K	black	black	RARA22-B4545

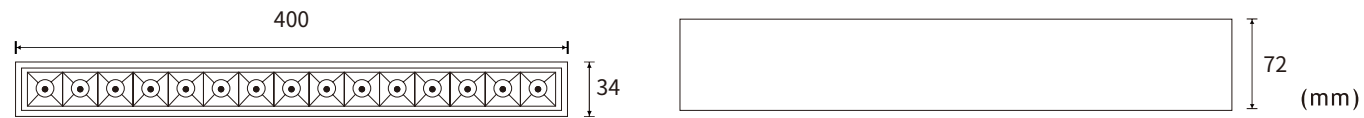

### Optical Parameters



S - Spot  
α 15°

M - Medium  
α 30°

WF - wide Flood  
α 45°

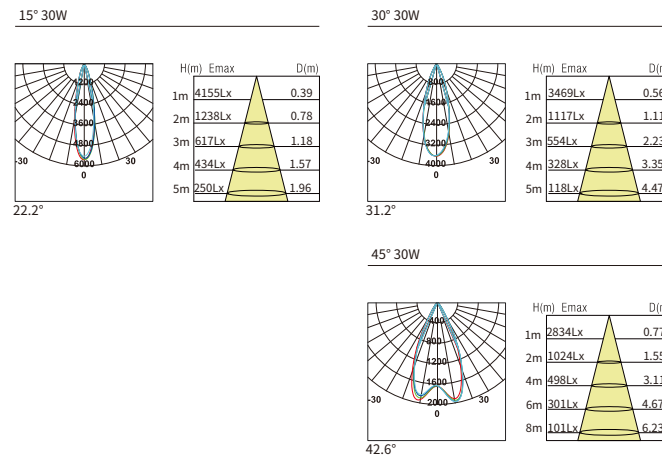

### LED & Driver

CREE XPG2:  
Power: 1-3W/LED  
Voltage: 3V  
SDCM<3  
MEANWELL Driver:  
Input Voltage:85-265VAC  
/220-240V/110-130V  
Output Voltage:DC24V  
Power:100-350W



G.W.:25.50kgs  
Packaging:69x51x40cm,25PCS/CTN

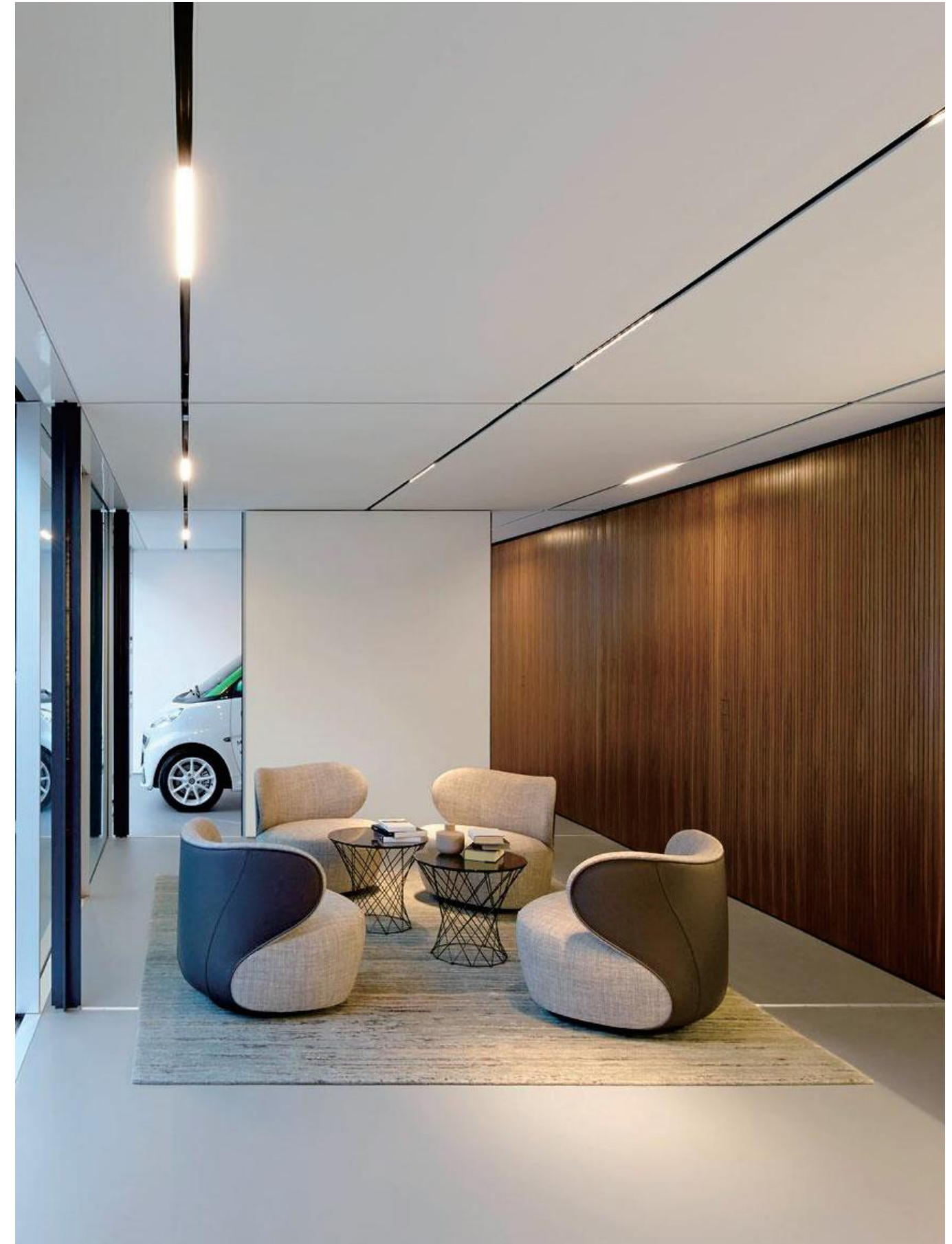

Magni

Power	CRI	Beam Angle	Luminous Flux	CCT	Refractive screen	Housing	Model Number
10W	>90	15°	570lm	2700K	black	black	MAR10-B2715
			630lm	3000K	black	black	MAR10-B3015
			710lm	4000K	black	black	MAR10-B4015
		30°	570lm	2700K	black	black	MAR10-B2730
			630lm	3000K	black	black	MAR10-B3030
			710lm	4000K	black	black	MAR10-B4030
		45°	570lm	2700K	black	black	MAR10-B2745
			630lm	3000K	black	black	MAR10-B3045
			710lm	4000K	black	black	MAR10-B4045

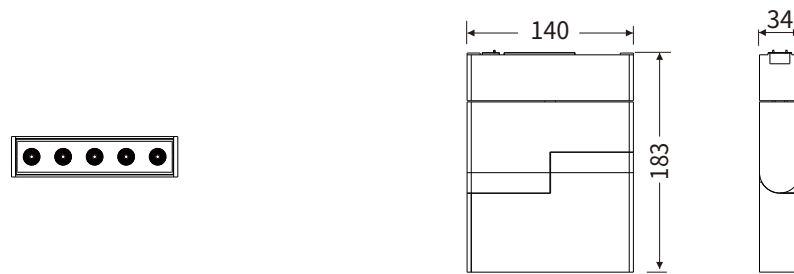

(mm)

Optical Parameters

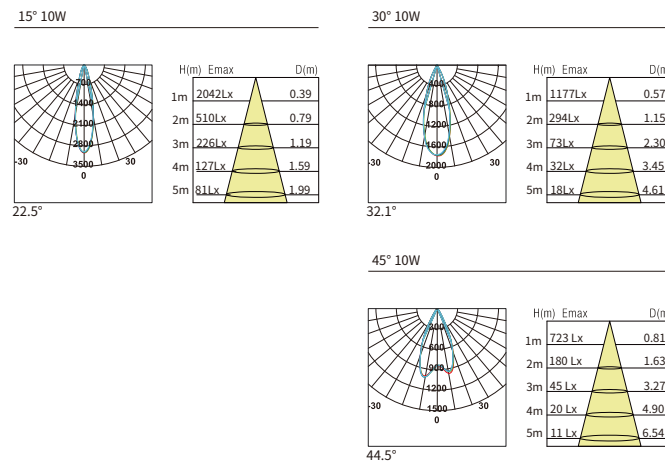
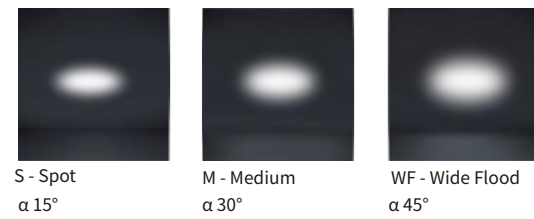

LED & Driver

CREE XPG2:  
Power: 1-3W/LED  
Voltage: 3V  
SDCM<3  
MEANWELL Driver:  
Input Voltage:85-265VAC  
/220-240V/110-130V  
Output Voltage:DC24V  
Power:100-350W



G.W.:25.50kgs  
Packaging:69x51x40cm,25PCS/CTN



Magni

Power	CRI	Beam Angle	Luminous Flux	CCT	Refractive screen	Housing	Model Number
20W	>90	15°	1140lm	2700K	black	black	MAR20-B2715
			1260lm	3000K	black	black	MAR20-B3015
			1420lm	4000K	black	black	MAR20-B4015
		30°	1140lm	2700K	black	black	MAR20-B2730
			1260lm	3000K	black	black	MAR20-B3030
			1420lm	4000K	black	black	MAR20-B4030
		45°	1140lm	2700K	black	black	MAR20-B2745
			1260lm	3000K	black	black	MAR20-B3045
			1420lm	4000K	black	black	MAR20-B4045

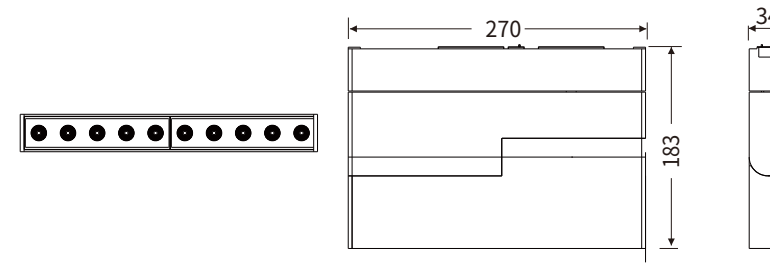

(mm)

Optical Parameters

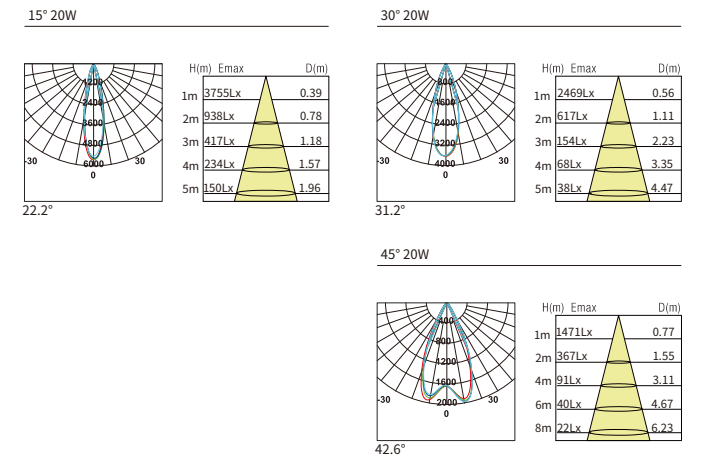
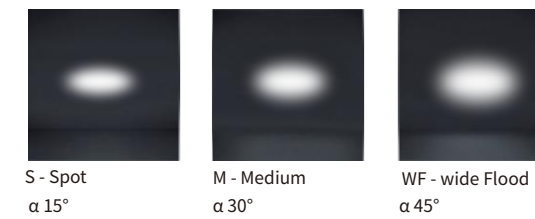

LED & Driver

CREE XPG2:  
Power: 1-3W/LED  
Voltage: 3V  
SDCM<3  
MEANWELL Driver:  
Input Voltage:85-265VAC  
/220-240V/110-130V  
Output Voltage:DC24V  
Power:100-350W



G.W.:25.50kgs  
Packaging:69x51x40cm,25PCS/CTN





LED Type: CREE IP20 ● Black as standard **Magni**

Power	CRI	Beam Angle	Luminous Flux	CCT	Housing	Model Number
6W	>90	10°	310lm	2700K	black	MAS06-B2710
			340lm	3000K	black	MAS06-B3010
			375lm	4000K	black	MAS06-B4010
		30°	310lm	2700K	black	MAS06-B2730
			340lm	3000K	black	MAS06-B3030
			375lm	4000K	black	MAS06-B4030

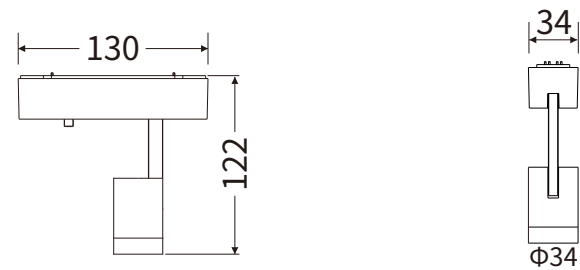

(mm)

Optical Parameters



S - Spot α 10°  
F - Flood α 30°

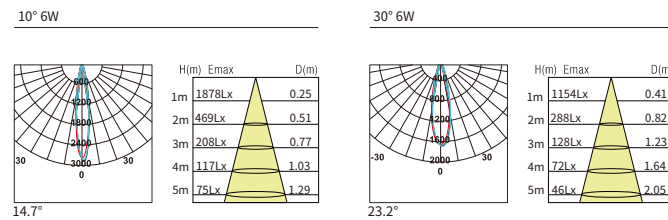

LED & Driver

CREE XPH35:  
Power: 6W/LED  
Voltage: 11V  
SDCM<3  
MEANWELL Driver:  
Input Voltage:85-265VAC  
/220-240V/110-130V  
Output Voltage:DC24V  
Power:100-350W



G.W.:9.0kgs  
Packaging:51x42x23cm,30PCS/CTN



LED Type: CREE IP20 ● Black as standard **Magni**

Power	CRI	Beam Angle	Luminous Flux	CCT	Housing	Model Number
12W	>90	14°	750lm	2700K	black	MAS12-B2714
			810lm	3000K	black	MAS12-B3014
			900lm	4000K	black	MAS12-B4014
		28°	750lm	2700K	black	MAS12-B2728
			810lm	3000K	black	MAS12-B3028
			900lm	4000K	black	MAS12-B4028
		40°	750lm	2700K	black	MAS12-B2740
			810lm	3000K	black	MAS12-B3040
			900lm	4000K	black	MAS12-B4040

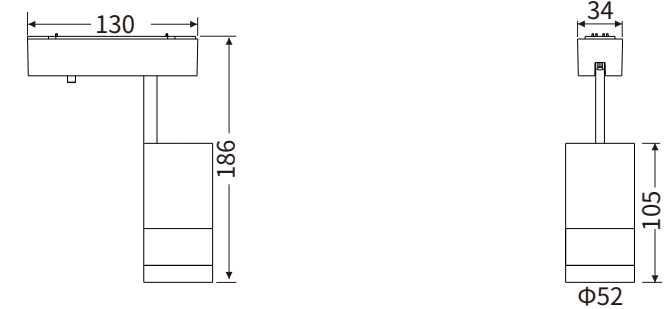

(mm)

Optical Parameters



S - Spot α 14°  
M - Medium α 28°  
WF - wide Flood α 40°

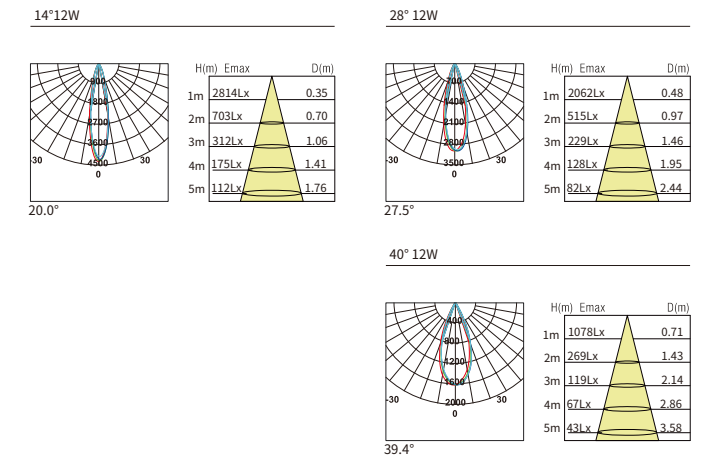

LED & Driver

CREE 1512  
Power: 12W/LED  
Voltage: 35V  
SDCM<3  
MEANWELL Driver:  
Input Voltage:85-265VAC  
/220-240V/110-130V  
Output Voltage:DC24V  
Power:100-350W



G.W.:19.50kgs  
Packaging:48.5x48.5x44.5cm,30PCS/CTN



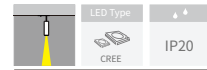

● Black as standard

# Magni

Power	CRI	Beam Angle	Luminous Flux	CCT	Housing	Model Number
13W	>90	10°	750lm	2700K	black	MAH13-B2710
			810lm	3000K	black	MAH13-B3010
			900lm	4000K	black	MAH13-B4010
		30°	750lm	2700K	black	MAH13-B2730
			810lm	3000K	black	MAH13-B3030
			900lm	4000K	black	MAH13-B4030

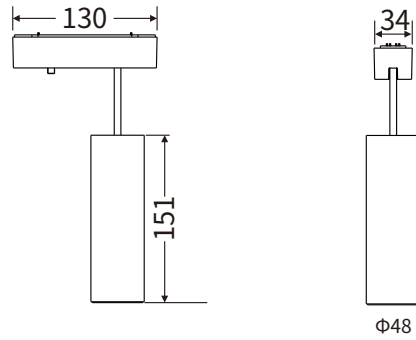

(mm)

## Optical Parameters

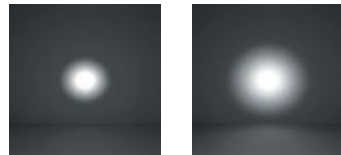

S - Superspot  
α 10°

F - Flood  
α 30°

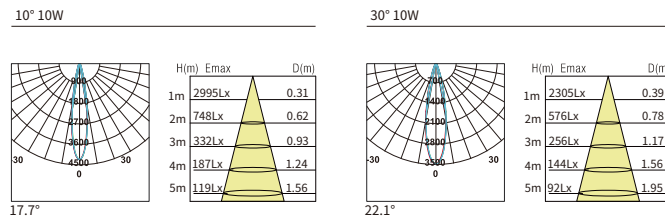

## LED & Driver

CREE XPH35:  
Power: 10W/LED  
Voltage: 35V  
SDCM<3  
MEANWELL Driver:  
Input Voltage:85-265VAC  
/220-240V/110-130V  
Output Voltage:DC24V  
Power:100-350W



G.W.:19.50kgs  
Packaging:57x50x39cm,30PCS/CTN

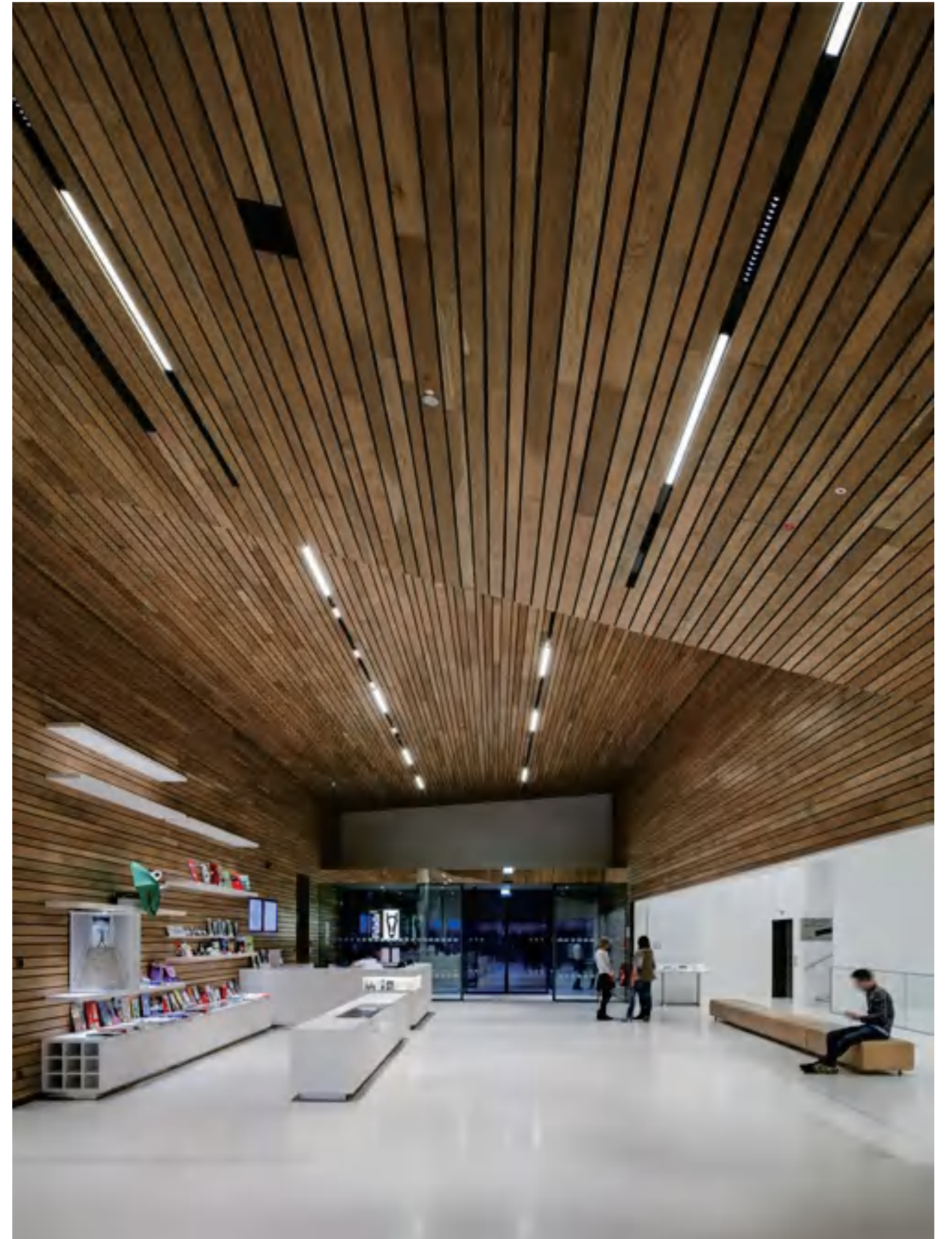



LED Type: CREE IP20 ● Black as standard **Magni**

Power	CRI	Beam Angle	Luminous Flux	CCT	Diffuser	Housing	Model Number
7.5W	>90	100°	525lm	2700K	PC	black	MAL7.5-B27
			563lm	3000K	PC	black	MAL7.5-B30
			600lm	4000K	PC	black	MAL7.5-B40

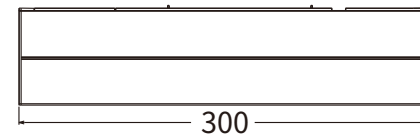
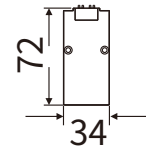
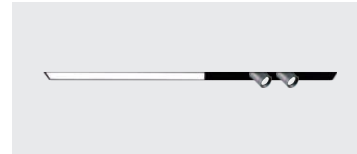

(mm)

Application

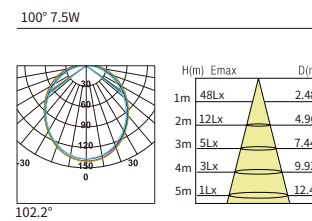
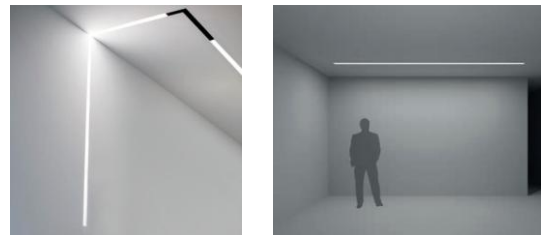

LED & Driver

Epistar smd2835:  
Power: 0.2W/LED  
Voltage: 9V  
SDCM<3  
MEANWELL Driver:  
Input Voltage:85-265VAC  
/220-240V/110-130V  
Output Voltage:DC24V  
Power:100-350W



G.W.:8.50kgs  
Packaging:37x44.5x40cm,12PCS/CTN



LED Type: CREE IP20 ● Black as standard **Magni**

Power	CRI	Beam Angle	Luminous Flux	CCT	Diffuser	Housing	Model Number
15W	>90	100°	1050lm	2700K	PC	black	MAL15-B27
			1125lm	3000K	PC	black	MAL15-B30
			1200lm	4000K	PC	black	MAL15-B40

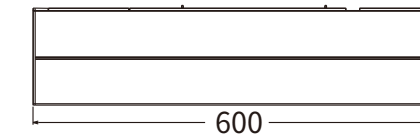
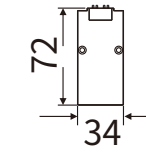
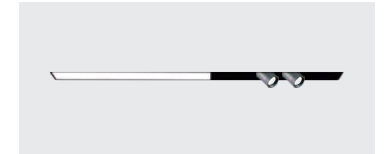
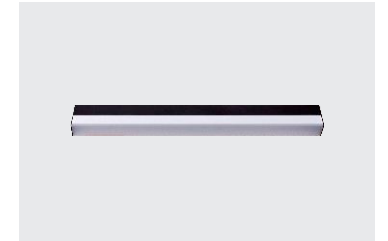

(mm)

Application

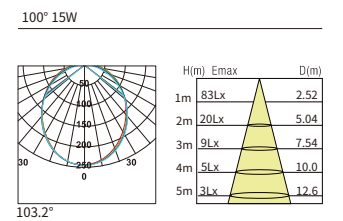

LED & Driver

Epistar smd2835:  
Power: 0.2W/LED  
Voltage: 9V  
SDCM<3  
MEANWELL Driver:  
Input Voltage:85-265VAC  
/220-240V/110-130V  
Output Voltage:DC24V  
Power:100-350W







G.W.:14.30kgs  
Packaging:67x44.5x40cm,12PCS/CTN



LED Type: CREE IP20 ● Black as standard **Magni**

Power	CRI	Beam Angle	Luminous Flux	CCT	Diffuser	Housing	Model Number
22.5W	>90	100°	1575lm	2700K	PC	black	MAL22.5-B27
			1688lm	3000K	PC	black	MAL22.5-B30
			1800lm	4000K	PC	black	MAL22.5-B40

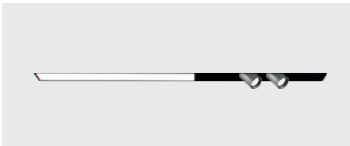
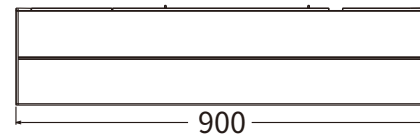
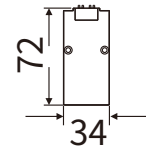
(mm)

Application

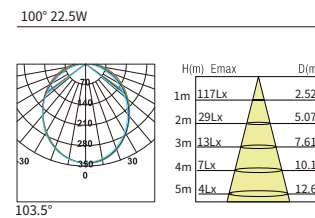
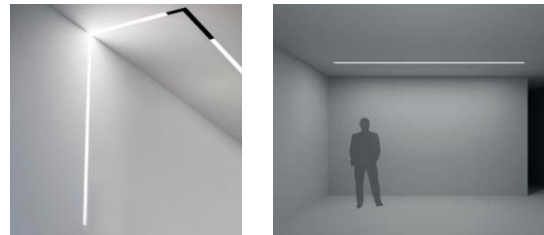

LED & Driver

Epistar smd2835:  
Power: 0.2W/LED  
Voltage: 9V  
SDCM<3  
MEANWELL Driver:  
Input Voltage:85-265VAC  
/220-240V/110-130V  
Output Voltage:DC24V  
Power:100-350W







G.W.:17.00kgs  
Packaging:97x44.5x40cm,9PCS/CTN



LED Type: CREE IP20 ● Black as standard **Magni**

Power	CRI	Beam Angle	Luminous Flux	CCT	Diffuser	Housing	Model Number
30W	>90	100°	2100lm	2700K	PC	black	MAL30-B27
			2250lm	3000K	PC	black	MAL30-B30
			2400lm	4000K	PC	black	MAL30-B40

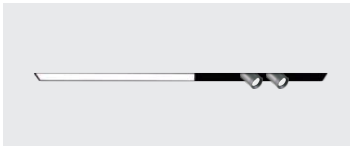
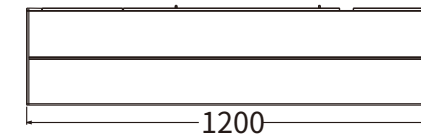
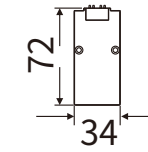
(mm)

Application

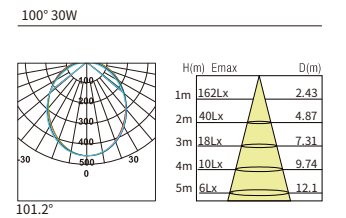

LED & Driver

Epistar smd2835:  
Power: 0.2W/LED  
Voltage: 9V  
SDCM<3  
MEANWELL Driver:  
Input Voltage:85-265VAC  
/220-240V/110-130V  
Output Voltage:DC24V  
Power:100-350W



G.W.:19.80kgs  
Packaging:127x44.5x40cm,9PCS/CTN





Magnetic track system ● Black color as standard

# Magni

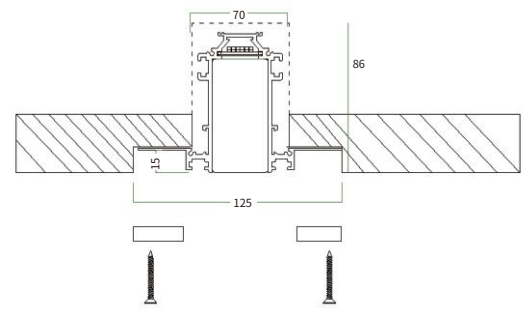

Dimension Unit: mm

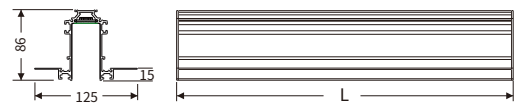

■(L)Track standard length:1000/1500/2500/3000

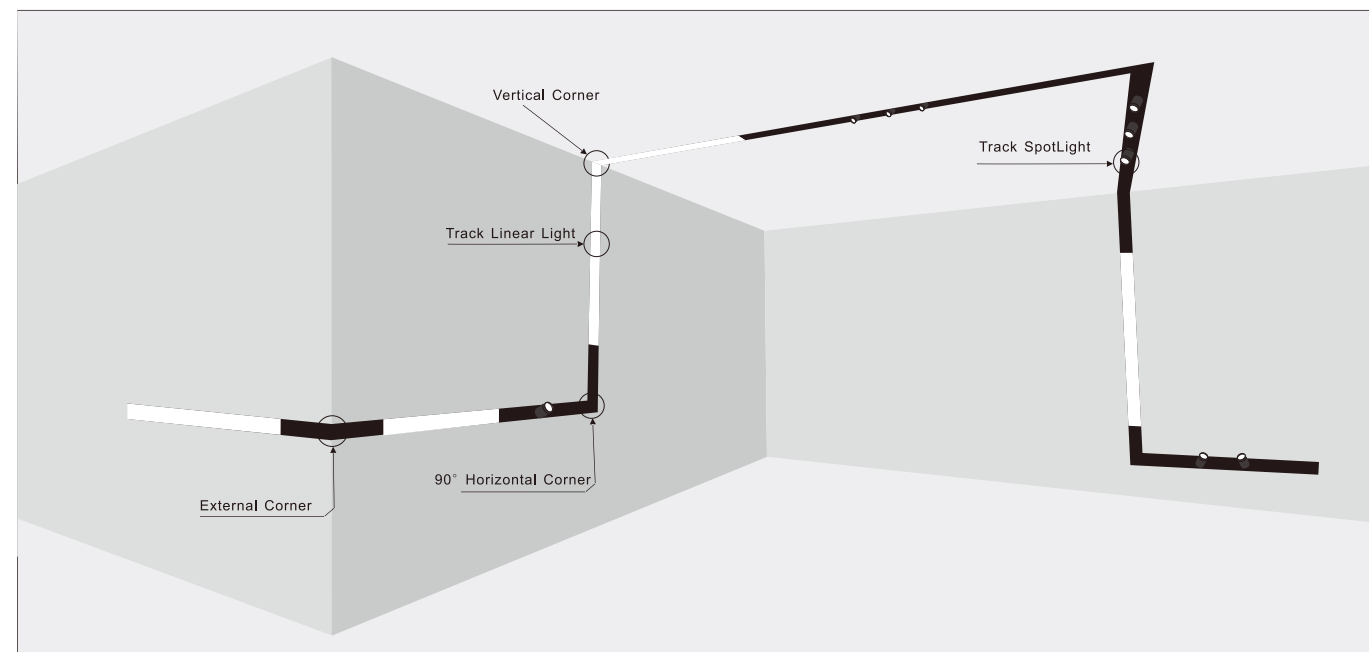
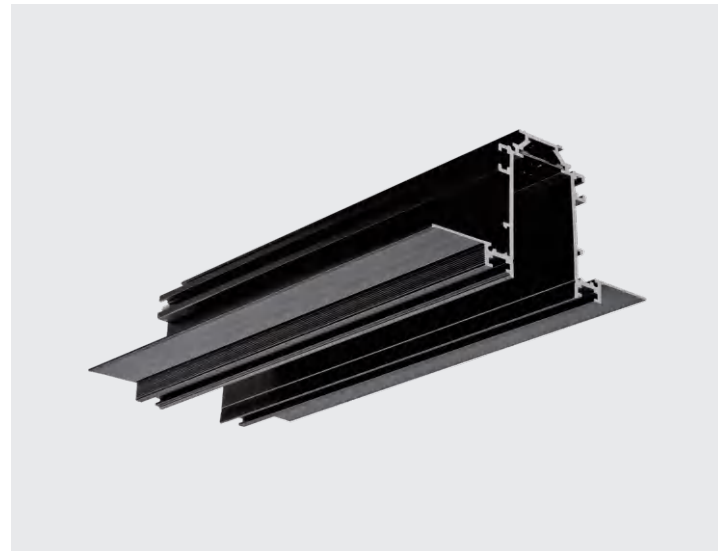

Model	Model Number
Recessed track 1 meter	RE-MT100
Recessed track 1.5 meter	RE-MT150
Recessed track 2.5 meter	RE-MT250
Recessed track 3 meter	RE-MT300
Horizontal corner	RE-HOR90
Vertical corner	RE-VER90
External corner	RE-EXT90
PCB connector	PCB-CON100
PCB connector	PCB-CON50
Track connector	TRACK-CON
End cap	RE-MTAC

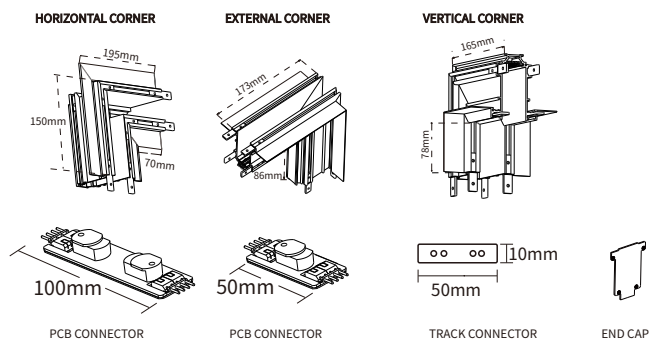

Magnetic track system ● Black color as standard

# Magni

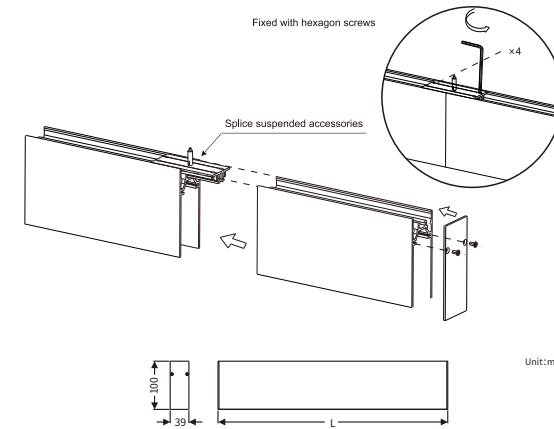

■(L)Track standard length:1000/1500/2500/3000

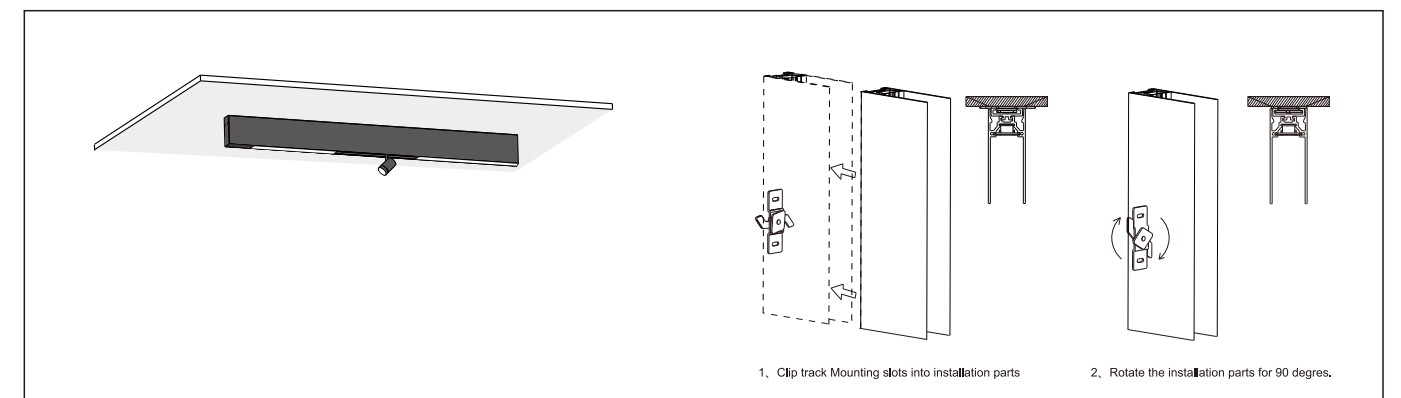
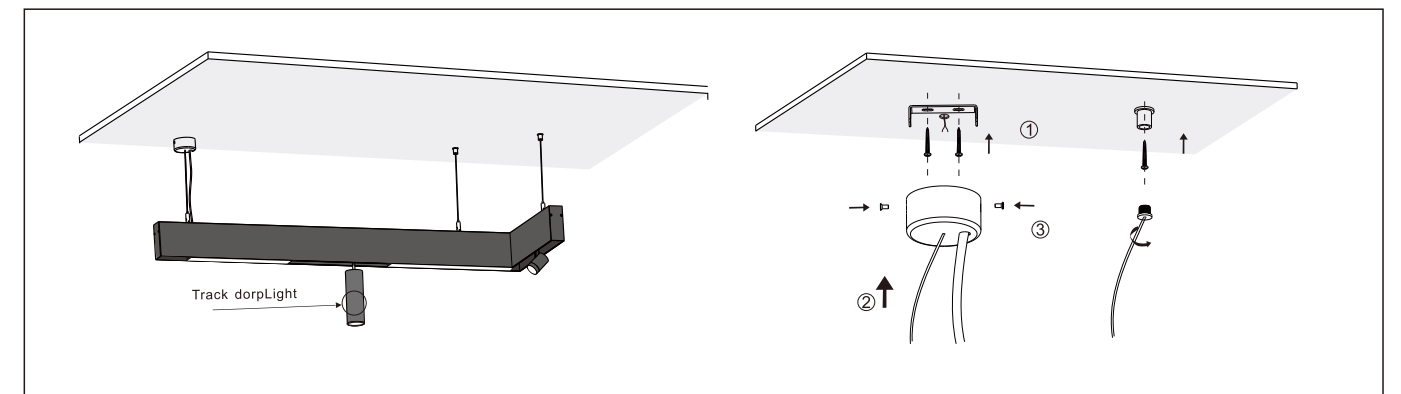

Model	Model Number
Recessed track 1 meter	SU-MT100
Recessed track 1.5 meter	SU-MT150
Recessed track 2.5 meter	SU-MT250
Recessed track 3 meter	SU-MT300
Horizontal corner	SU-HOR90
Vertical corner	SU-VER90
External corner	SU-EXT90
PCB connector	PCB-CON100
PCB connector	PCB-CON50
Track connector	TRACK-CON
End cap	SU-MTAC
Suspended kit	SUS-MTCON
Surface part	SUR-MTCON

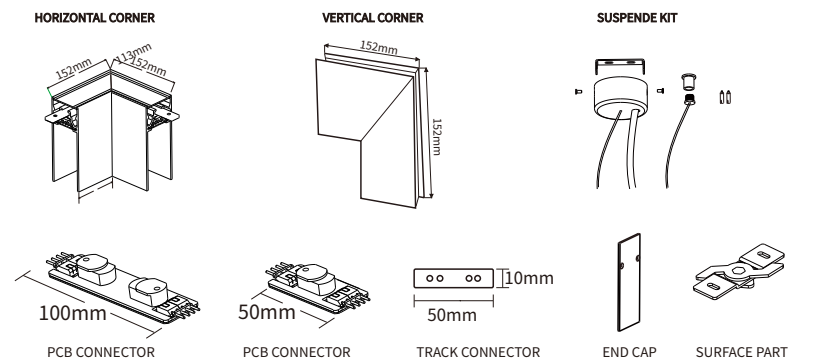

Surface track optional in two heights of 65mm and 100mm.



# Prolight





Normal IP rating: IP20  
Maximum IP rating: IP65

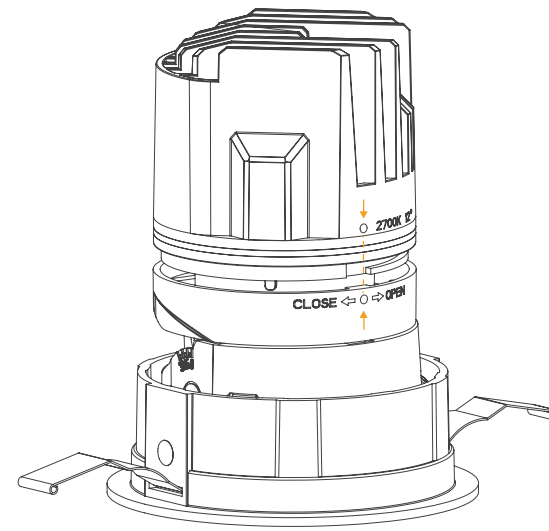

Precise angle alignment  
Self-contained led engine will be opened/closed via twist&lock system

One design for fixed or adjustable performance



White    Grey    Wine    Black

Self-contained LED engine in four colours with industrial design





## Modular Design



Optional accessories give the designr flexibility in combination of different luminaires.

Anti-glare sleeve achieves cut-off angle >40°, UGR <6.

The lighting tool for perfectly glare-free light from ceiling.

LED Type: CREE IP20 White as standard **Prolight**

Power	CRI	BeamAngle	Luminous Flux	CCT	Frame	Model Number
9W	>90	15°	600lm	2700K	white	PRO-FR09-W2715
			630lm	3000K	white	PRO-FR09-W3015
			630lm	4000K	white	PRO-FR09-W4015
		24°	600lm	2700K	white	PRO-FR09-W2724
			630lm	3000K	white	PRO-FR09-W3024
			630lm	4000K	white	PRO-FR09-W4024
		36°	600lm	2700K	white	PRO-FR09-W2736
			630lm	3000K	white	PRO-FR09-W3036
			630lm	4000K	white	PRO-FR09-W4036
		60°	630lm	2700K	white	PRO-FR09-W2760
			630lm	3000K	white	PRO-FR09-W3060
			630lm	4000K	white	PRO-FR09-W4060

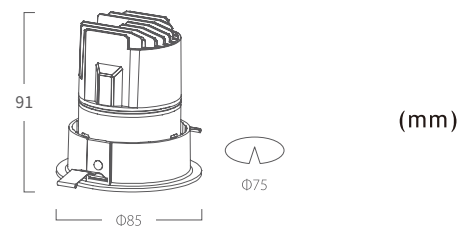

Optical Parameters

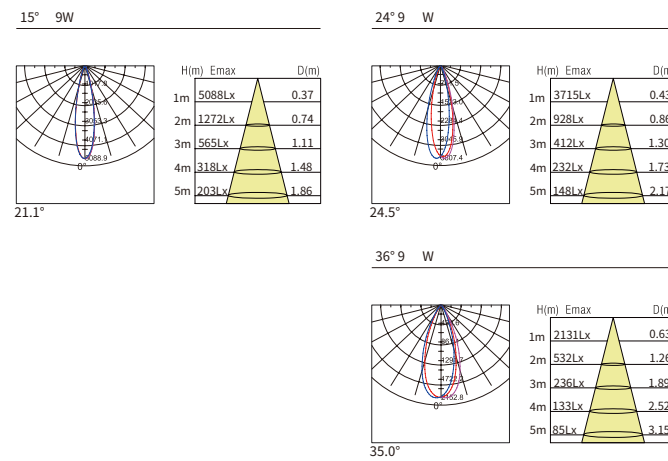

LED & Driver

Luminus COB  
 Power: 13W/LED  
 Voltage: 36V  
 SDCM<3  
 MEANWELL Driver:  
 Input voltage:100-240VAC  
 /220-240V/110-130V  
 Output current:200mA  
 Output voltage:DC36-40V



LED Type: CREE IP20 White as standard **Prolight trimless**

Power	CRI	BeamAngle	Luminous Flux	CCT	Frame	Model Number
9W	>90	15°	600lm	2700K	white	PRO-TR09-W2715
			630lm	3000K	white	PRO-TR09-W3015
			630lm	4000K	white	PRO-TR09-W4015
		24°	600lm	2700K	white	PRO-TR09-W2724
			630lm	3000K	white	PRO-TR09-W3024
			630lm	4000K	white	PRO-TR09-W4024
		36°	600lm	2700K	white	PRO-TR09-W2736
			630lm	3000K	white	PRO-TR09-W3036
			630lm	4000K	white	PRO-TR09-W4036
		60°	630lm	2700K	white	PRO-TR09-W2760
			630lm	3000K	white	PRO-TR09-W3060
			630lm	4000K	white	PRO-TR09-W4060

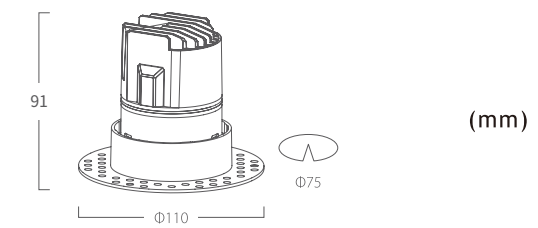

Optical Parameters

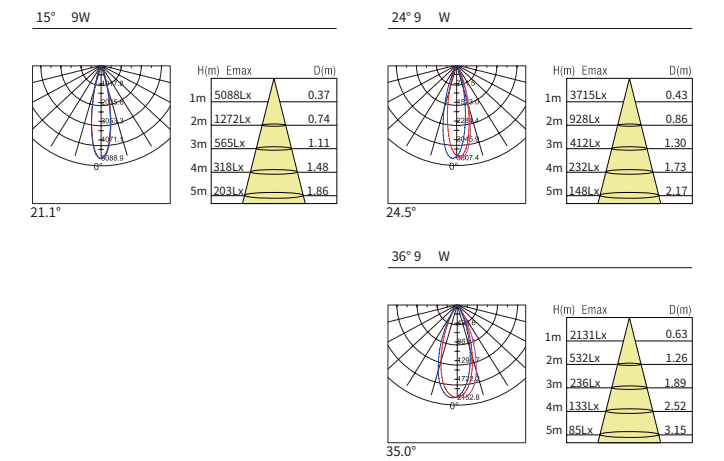

LED & Driver

Luminus COB  
 Power: 13W/LED  
 Voltage: 36V  
 SDCM<3  
 MEANWELL Driver:  
 Input voltage:100-240VAC  
 /220-240V/110-130V  
 Output current:200mA  
 Output voltage:DC36-40V





LED Type: CREE IP20 White as standard **Prolight**

Power	CRI	BeamAngle	Luminous Flux	CCT	Frame	Model Number
9W	>90	15°	600lm	2700K	white	PRO-FS09-W2715
			630lm	3000K	white	PRO-FS09-W3015
			630lm	4000K	white	PRO-FS09-W4015
		24°	600lm	2700K	white	PRO-FS09-W2724
			630lm	3000K	white	PRO-FS09-W3024
			630lm	4000K	white	PRO-FS09-W4024
		36°	600lm	2700K	white	PRO-FS09-W2736
			630lm	3000K	white	PRO-FS09-W3036
			630lm	4000K	white	PRO-FS09-W4036
		60°	630lm	2700K	white	PRO-FS09-W2760
			630lm	3000K	white	PRO-FS09-W3060
			630lm	4000K	white	PRO-FS09-W4060

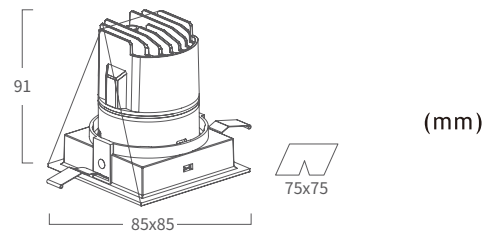

Optical Parameters



Direct

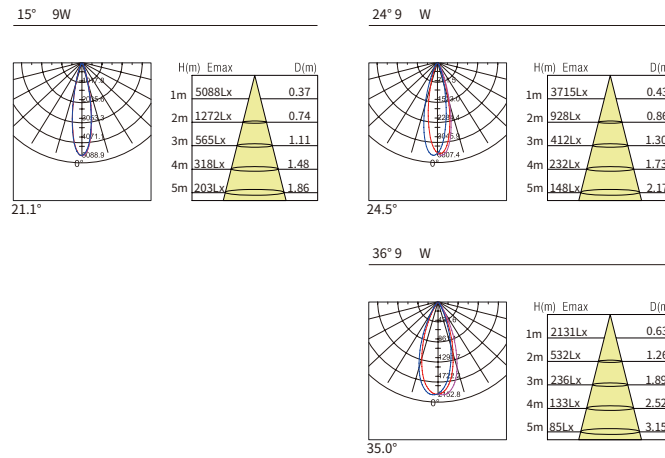

LED & Driver

Luminus COB  
 Power: 13W/LED  
 Voltage: 36V  
 SDCM<3  
 MEANWELL Driver:  
 Input voltage:100-240VAC  
 /220-240V/110-130V  
 Output current:200mA  
 Output voltage:DC36-40V



LED Type: CREE IP20 White as standard **Prolight trimless**

Power	CRI	BeamAngle	Luminous Flux	CCT	Frame	Model Number
9W	>90	15°	600lm	2700K	white	PRO-TS09-W2715
			630lm	3000K	white	PRO-TS09-W3015
			630lm	4000K	white	PRO-TS09-W4015
		24°	600lm	2700K	white	PRO-TS09-W2724
			630lm	3000K	white	PRO-TS09-W3024
			630lm	4000K	white	PRO-TS09-W4024
		36°	600lm	2700K	white	PRO-TS09-W2736
			630lm	3000K	white	PRO-TS09-W3036
			630lm	4000K	white	PRO-TS09-W4036
		60°	630lm	2700K	white	PRO-TS09-W2760
			630lm	3000K	white	PRO-TS09-W3060
			630lm	4000K	white	PRO-TS09-W4060

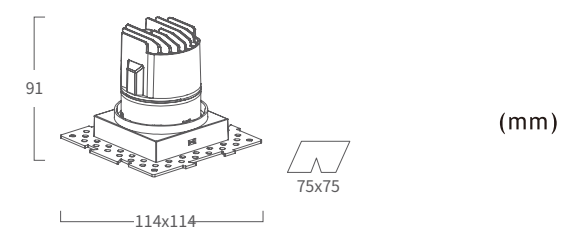
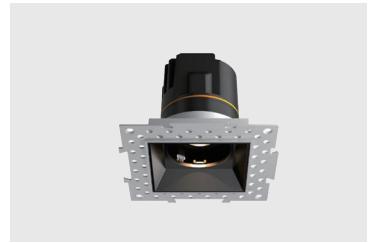

Optical Parameters



Direct

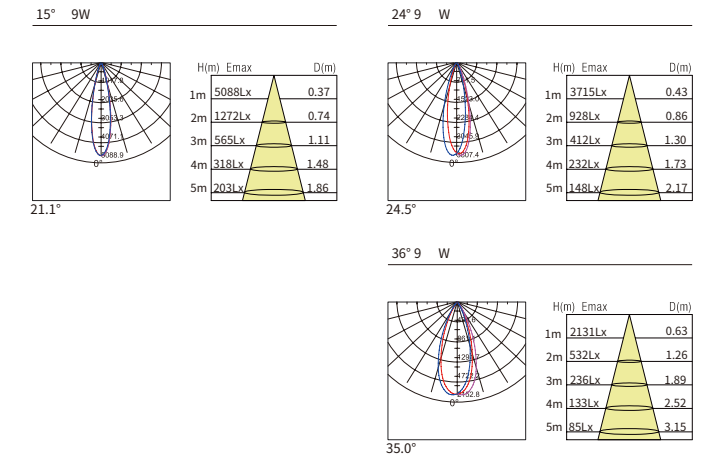

LED & Driver

Luminus COB  
 Power: 13W/LED  
 Voltage: 36V  
 SDCM<3  
 MEANWELL Driver:  
 Input voltage:100-240VAC  
 /220-240V/110-130V  
 Output current:200mA  
 Output voltage:DC36-40V



LED Type: CREE IP20 White as standard **Prolight**

Power	CRI	BeamAngle	Luminous Flux	CCT	Frame	Model Number
9W	>90	15°	600lm	2700K	white	PRO-AS09-W2715
			630lm	3000K	white	PRO-AS09-W3015
			630lm	4000K	white	PRO-AS09-W4015
		24°	600lm	2700K	white	PRO-AS09-W2724
			630lm	3000K	white	PRO-AS09-W3024
			630lm	4000K	white	PRO-AS09-W4024
		36°	600lm	2700K	white	PRO-AS09-W2736
			630lm	3000K	white	PRO-AS09-W3036
			630lm	4000K	white	PRO-AS09-W4036
		60°	630lm	2700K	white	PRO-AS09-W2760
			630lm	3000K	white	PRO-AS09-W3060
			630lm	4000K	white	PRO-AS09-W4060

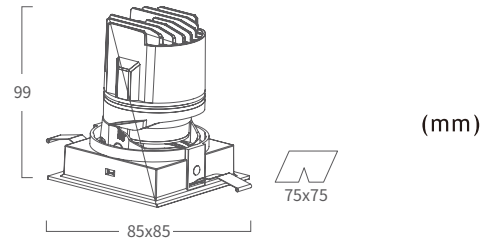
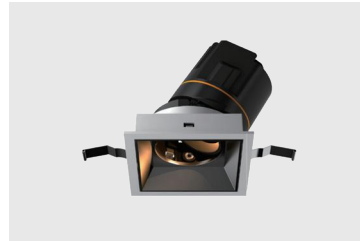

Optical Parameters



Direct

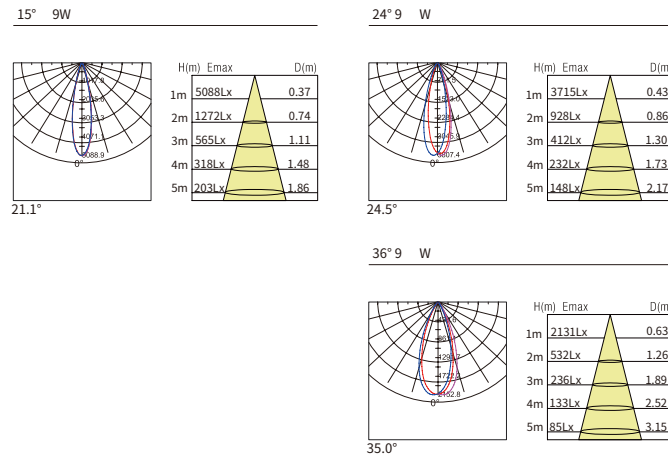

LED & Driver

Luminus COB  
 Power: 13W/LED  
 Voltage: 36V  
 SDCM<3  
 MEANWELL Driver:  
 Input voltage:100-240VAC  
 /220-240V/110-130V  
 Output current:200mA  
 Output voltage:DC36-40V



LED Type: CREE IP20 White as standard **Prolight trimless**

Power	CRI	BeamAngle	Luminous Flux	CCT	Frame	Model Number
9W	>90	15°	600lm	2700K	white	PRO-TAS09-W2715
			630lm	3000K	white	PRO-TAS09-W3015
			630lm	4000K	white	PRO-TAS09-W4015
		24°	600lm	2700K	white	PRO-TAS09-W2724
			630lm	3000K	white	PRO-TAS09-W3024
			630lm	4000K	white	PRO-TAS09-W4024
		36°	600lm	2700K	white	PRO-TAS09-W2736
			630lm	3000K	white	PRO-TAS09-W3036
			630lm	4000K	white	PRO-TAS09-W4036
		60°	630lm	2700K	white	PRO-TAS09-W2760
			630lm	3000K	white	PRO-TAS09-W3060
			630lm	4000K	white	PRO-TAS09-W4060

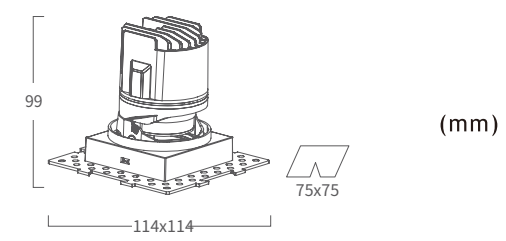

Optical Parameters



Direct

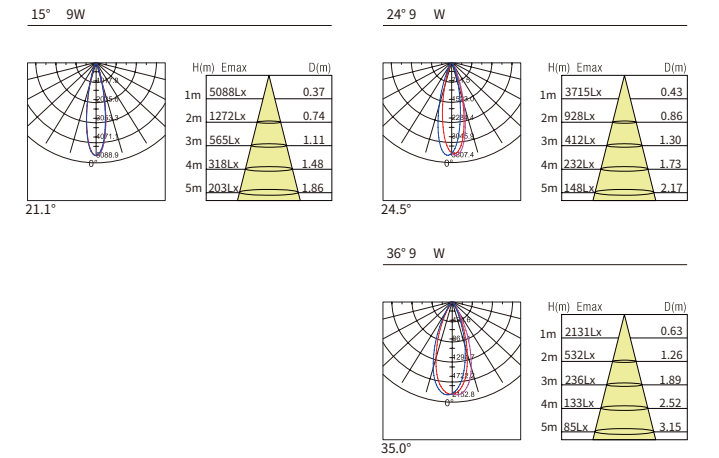

LED & Driver

Luminus COB  
 Power: 13W/LED  
 Voltage: 36V  
 SDCM<3  
 MEANWELL Driver:  
 Input voltage:100-240VAC  
 /220-240V/110-130V  
 Output current:200mA  
 Output voltage:DC36-40V



LED Type: CREE IP20 White as standard **Prolight**

Power	CRI	BeamAngle	Luminous Flux	CCT	Frame	Model Number
9W	>90	15°	600lm	2700K	white	PRO-AR09-W2715
			630lm	3000K	white	PRO-AR09-W3015
			630lm	4000K	white	PRO-AR09-W4015
		24°	600lm	2700K	white	PRO-AR09-W2724
			630lm	3000K	white	PRO-AR09-W3024
			630lm	4000K	white	PRO-AR09-W4024
		36°	600lm	2700K	white	PRO-AR09-W2736
			630lm	3000K	white	PRO-AR09-W3036
			630lm	4000K	white	PRO-AR09-W4036
		60°	630lm	2700K	white	PRO-AR09-W2760
			630lm	3000K	white	PRO-AR09-W3060
			630lm	4000K	white	PRO-AR09-W4060

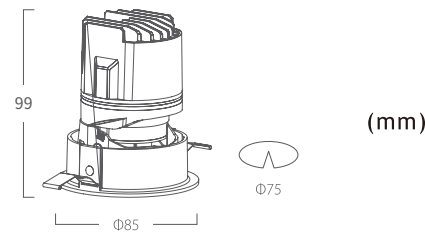

Optical Parameters

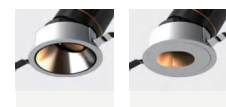

Direct Arc

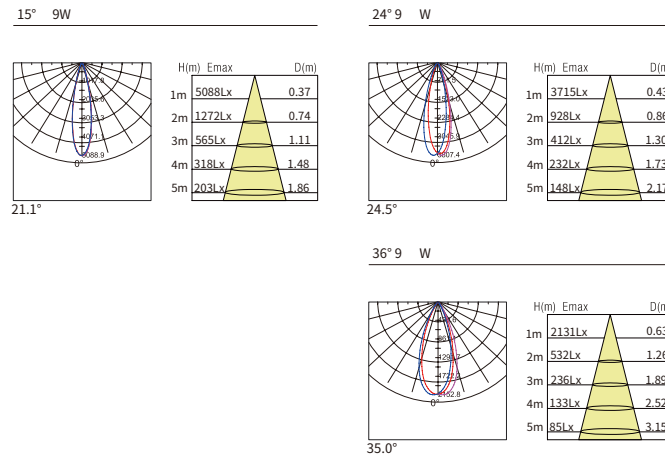

LED & Driver

Luminus COB  
 Power: 13W/LED  
 Voltage: 36V  
 SDCM<3  
 MEANWELL Driver:  
 Input voltage:100-240VAC  
 /220-240V/110-130V  
 Output current:200mA  
 Output voltage:DC36-40V



LED Type: CREE IP20 White as standard **Prolight trimless**

Power	CRI	BeamAngle	Luminous Flux	CCT	Frame	Model Number
9W	>90	15°	600lm	2700K	white	PRO-TAR09-W2715
			630lm	3000K	white	PRO-TAR09-W3015
			630lm	4000K	white	PRO-TAR09-W4015
		24°	600lm	2700K	white	PRO-TAR09-W2724
			630lm	3000K	white	PRO-TAR09-W3024
			630lm	4000K	white	PRO-TAR09-W4024
		36°	600lm	2700K	white	PRO-TAR09-W2736
			630lm	3000K	white	PRO-TAR09-W3036
			630lm	4000K	white	PRO-TAR09-W4036
		60°	630lm	2700K	white	PRO-TAR09-W2760
			630lm	3000K	white	PRO-TAR09-W3060
			630lm	4000K	white	PRO-TAR09-W4060

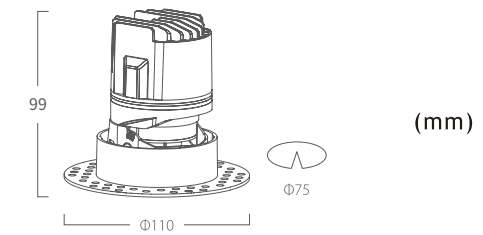

Optical Parameters

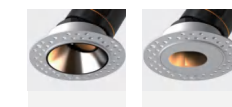

Direct Arc

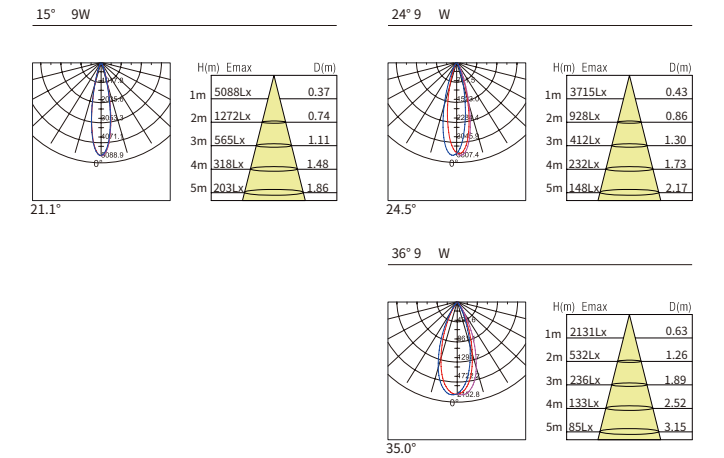

LED & Driver

Luminus COB  
 Power: 13W/LED  
 Voltage: 36V  
 SDCM<3  
 MEANWELL Driver:  
 Input voltage:100-240VAC  
 /220-240V/110-130V  
 Output current:200mA  
 Output voltage:DC36-40V





LED Type: CREE IP20 White as standard

Power	CRI	BeamAngle	Luminous Flux	CCT	Type	Frame	Model Number
12W	>90	wallwasher	700lm	2700K	trim	white	PRO-WWR12-W27
			720lm	3000K	trim	white	PRO-WWR12-W30
			720lm	4000K	trim	white	PRO-WWR12-W40
			700lm	2700K	trimless	white	PRO-WWTR12-W27
			720lm	3000K	trimless	white	PRO-WWTR12-W30
			720lm	4000K	trimless	white	PRO-WWTR12-W40

### Prolight Wallwasher

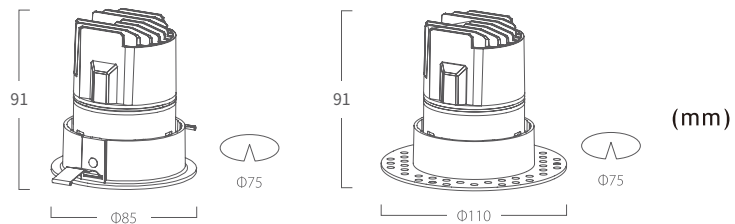

(mm)

wall washer 12W

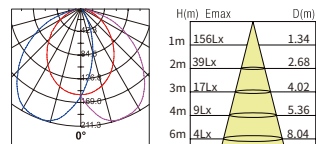

#### LED & Driver

Luminus COB  
 Power: 13W/LED  
 Voltage: 36V  
 SDCM<3  
 Philips Driver:  
 Input voltage:100-240VAC  
 /220-240V/110-130V  
 Output current:300mA  
 Output voltage:DC36-40V



LED Type: CREE IP20 White as standard

Power	CRI	BeamAngle	Luminous Flux	CCT	Type	Frame	Model Number
12W	>90	wallwasher	700lm	2700K	trim	white	PRO-WWS12-W27
			720lm	3000K	trim	white	PRO-WWS12-W30
			720lm	4000K	trim	white	PRO-WWS12-W40
			700lm	2700K	trimless	white	PRO-WWTS12-W27
			720lm	3000K	trimless	white	PRO-WWTS12-W30
			720lm	4000K	trimless	white	PRO-WWTS12-W40

### Prolight Wallwasher

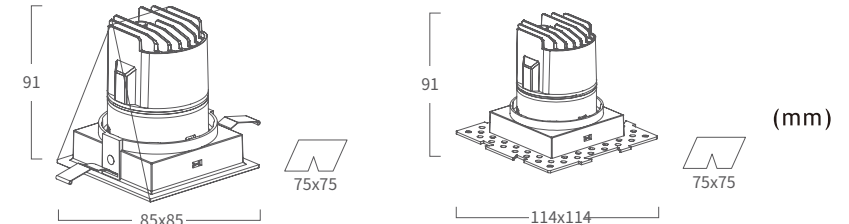

(mm)

wall washer 12W

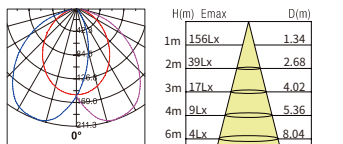

#### LED & Driver

Luminus COB  
 Power: 13W/LED  
 Voltage: 36V  
 SDCM<3  
 Philips Driver:  
 Input voltage:100-240VAC  
 /220-240V/110-130V  
 Output current:300mA  
 Output voltage:DC36-40V



LED Type: CREE IP20 White as standard **Prolight**

Power	CRI	BeamAngle	Luminous Flux	CCT	Refractive screen	Frame	Model Number
20W	>90	15°	1300lm	2700K	chrome	white	PRO-AR20-WC2715
			1300lm	3000K	chrome	white	PRO-AR20-WC3015
			1300lm	4000K	chrome	white	PRO-AR20-WC4015
		24°	1300lm	2700K	chrome	white	PRO-AR20-WC2724
			1300lm	3000K	chrome	white	PRO-AR20-WC3024
			1300lm	4000K	chrome	white	PRO-AR20-WC4024
		36°	1300lm	2700K	chrome	white	PRO-AR20-WC2736
			1300lm	3000K	chrome	white	PRO-AR20-WC3036
			1300lm	4000K	chrome	white	PRO-AR20-WC4036
60°	1300lm	2700K	chrome	white	PRO-AR20-WC2760		
	1300lm	3000K	chrome	white	PRO-AR20-WC3060		
	1300lm	4000K	chrome	white	PRO-AR20-WC4060		

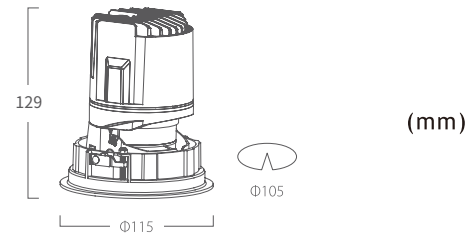

Optical Parameters

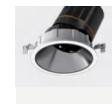

Direct

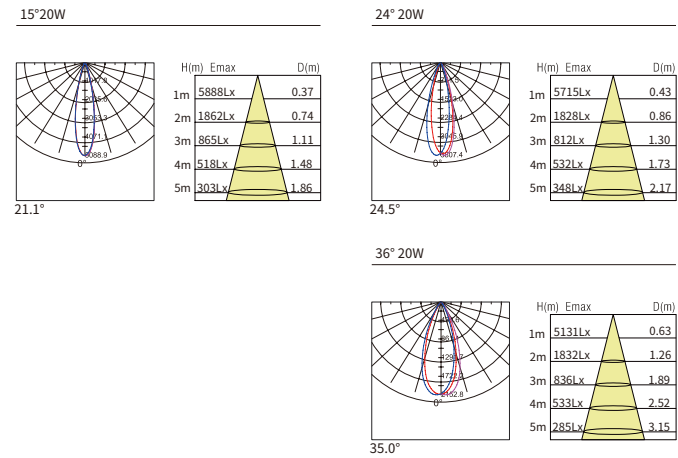

LED & Driver

Luminus COB  
 Power: 26W/LED  
 Voltage: 36V  
 SDCM<3  
 Philips Driver:  
 Input voltage:100-240VAC  
 /220-240V/110-130V  
 Output current:500mA  
 Output voltage:DC36-40V



LED Type: CREE IP20 White as standard **Prolight**

Power	CRI	BeamAngle	Luminous Flux	CCT	Refractive screen	Frame	Model Number
35W	>90	15°	2200lm	2700K	chrome	white	PRO-FAR35-WC2715
			2200lm	3000K	chrome	white	PRO-FAR35-WC3015
			2200lm	4000K	chrome	white	PRO-FAR35-WC4015
			2200lm	2700K	chrome	white	PRO-FAR35-WC2724
		24°	2200lm	3000K	chrome	white	PRO-FAR35-WC3024
			2200lm	4000K	chrome	white	PRO-FAR35-WC4024
			2200lm	2700K	chrome	white	PRO-FAR35-WC2736
			2200lm	3000K	chrome	white	PRO-FAR35-WC3036
		36°	2200lm	4000K	chrome	white	PRO-FAR35-WC4036
			2200lm	2700K	chrome	white	PRO-FAR35-WC2760
			2200lm	3000K	chrome	white	PRO-FAR35-WC3060
			2200lm	4000K	chrome	white	PRO-FAR35-WC4060

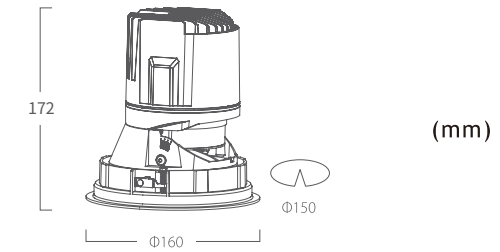

Optical Parameters

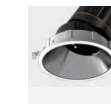

Direct

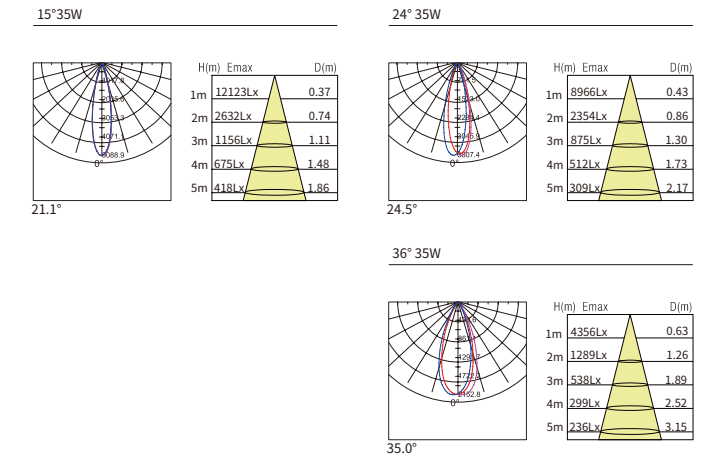

LED & Driver

Luminus COB  
 Power: 40W/LED  
 Voltage: 36V  
 SDCM<3  
 Philips Driver:  
 Input voltage:100-240VAC  
 /220-240V/110-130V  
 Output current:800mA  
 Output voltage:DC36-40V



LED Type: CREE IP20 White as standard **Prolight**

Power	CRI	BeamAngle	Luminous Flux	CCT	Refractive screen	Frame	Model Number
20W	>90	15°	1300lm	2700K	chrome	white	PRO-FR20-WC2715
			1300lm	3000K	chrome	white	PRO-FR20-WC3015
			1300lm	4000K	chrome	white	PRO-FR20-WC4015
		24°	1300lm	2700K	chrome	white	PRO-FR20-WC2724
			1300lm	3000K	chrome	white	PRO-FR20-WC3024
			1300lm	4000K	chrome	white	PRO-FR20-WC4024
		36°	1300lm	2700K	chrome	white	PRO-FR20-WC2736
			1300lm	3000K	chrome	white	PRO-FR20-WC3036
			1300lm	4000K	chrome	white	PRO-FR20-WC4036
60°	1300lm	2700K	chrome	white	PRO-FR20-WC2760		
	1300lm	3000K	chrome	white	PRO-FR20-WC3060		
	1300lm	4000K	chrome	white	PRO-FR20-WC4060		

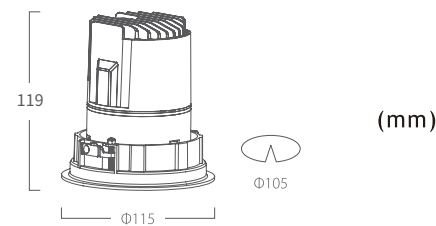

Optical Parameters

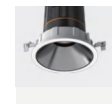

Direct

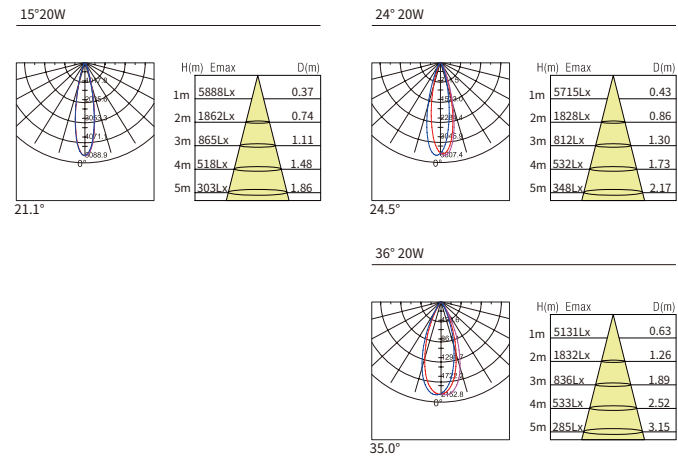

LED & Driver

Luminus COB  
 Power: 26W/LED  
 Voltage: 36V  
 SDCM<3  
 Philips Driver:  
 Input voltage:100-240VAC  
 /220-240V/110-130V  
 Output current:500mA  
 Output voltage:DC36-40V



LED Type: CREE IP20 White as standard **Prolight**

Power	CRI	BeamAngle	Luminous Flux	CCT	Refractive screen	Frame	Model Number
35W	>90	15°	2200lm	2700K	chrome	white	PRO-FR35-WC2715
			2200lm	3000K	chrome	white	PRO-FR35-WC3015
			2200lm	4000K	chrome	white	PRO-FR35-WC4015
			2200lm	2700K	chrome	white	PRO-FR35-WC2724
		24°	2200lm	2700K	chrome	white	PRO-FR35-WC2724
			2200lm	3000K	chrome	white	PRO-FR35-WC3024
			2200lm	4000K	chrome	white	PRO-FR35-WC4024
			2200lm	2700K	chrome	white	PRO-FR35-WC2736
		36°	2200lm	2700K	chrome	white	PRO-FR35-WC2736
			2200lm	3000K	chrome	white	PRO-FR35-WC3036
			2200lm	4000K	chrome	white	PRO-FR35-WC4036
			2200lm	2700K	chrome	white	PRO-FR35-WC2760
60°	2200lm	2700K	chrome	white	PRO-FR35-WC2760		
	2200lm	3000K	chrome	white	PRO-FR35-WC3060		
	2200lm	4000K	chrome	white	PRO-FR35-WC4060		
	2200lm	4000K	chrome	white	PRO-FR35-WC4060		

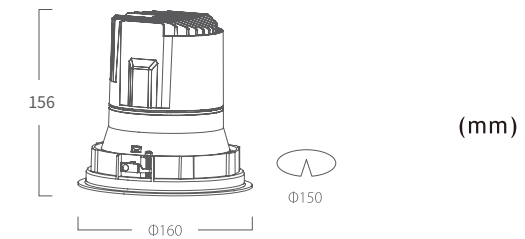

Optical Parameters



Direct

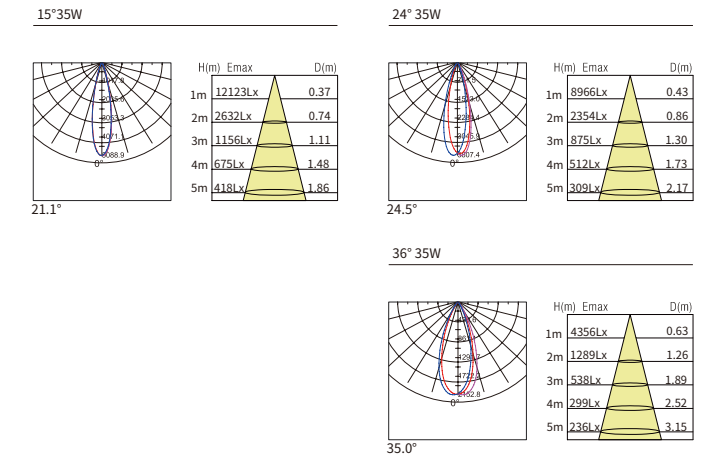

LED & Driver

Luminus COB  
 Power: 40W/LED  
 Voltage: 36V  
 SDCM<3  
 Philips Driver:  
 Input voltage:100-240VAC  
 /220-240V/110-130V  
 Output current:800mA  
 Output voltage:DC36-40V





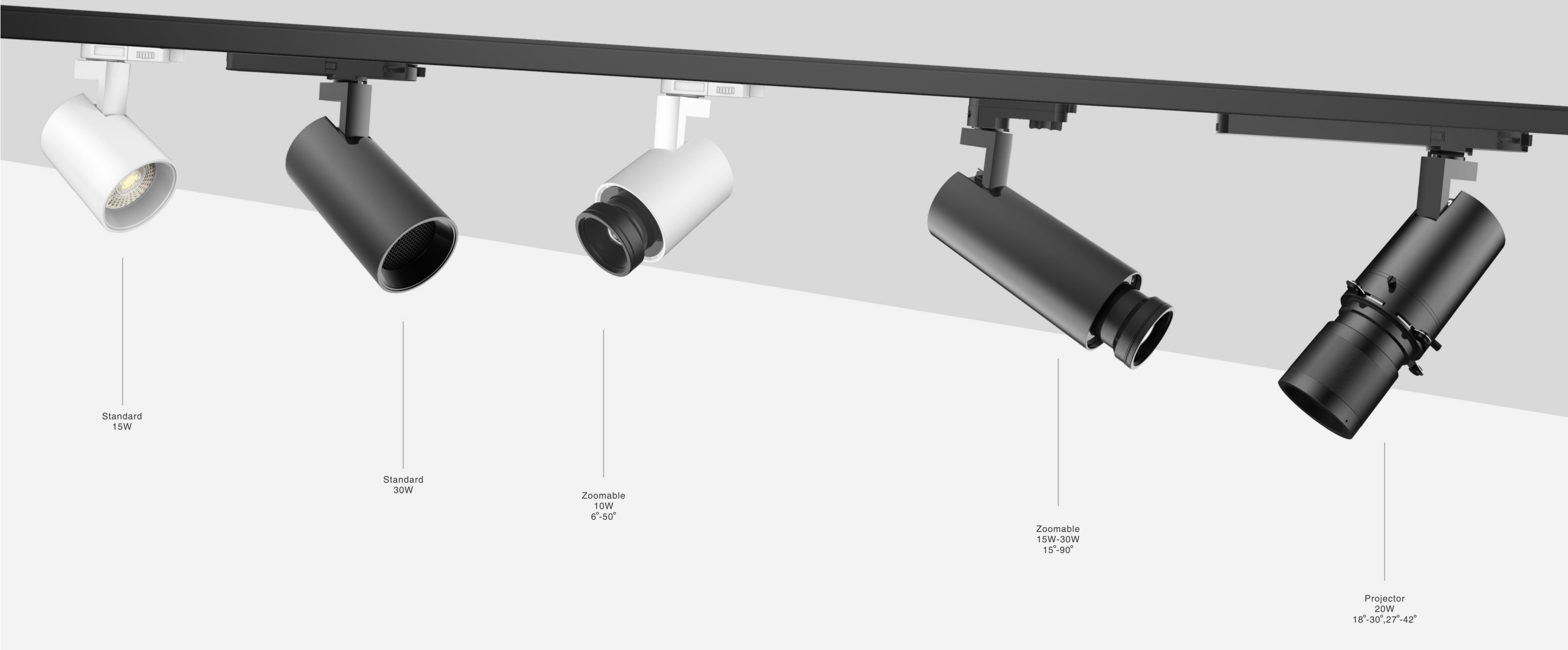

Standard  
15W

Standard  
30W

Zoomable  
10W  
6°-50°

Zoomable  
15W-30W  
15°-90°

Projector  
20W  
18°-30°, 27°-42°

# Sharp



Standard-small



Standard  
(20W)



Standard  
(30W)

Optical Accessories



Honeycomb Filter

Cross Louver

	>100 lm/W	CRI 90+	CRI 80+			Max 45°C -20°C	PF >0.90		
--	--------------	------------	------------	--	--	----------------------	-------------	--	--

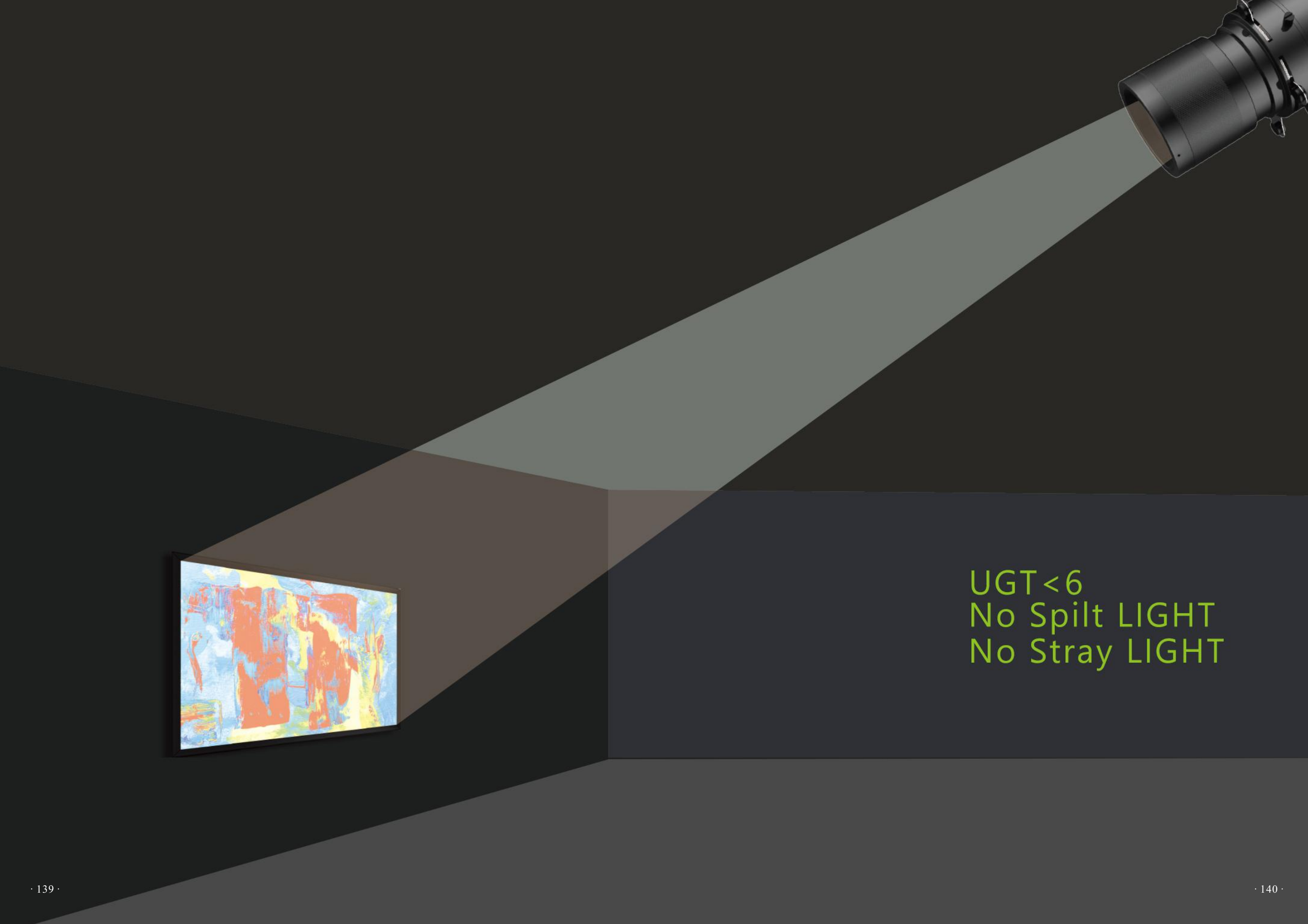

UGT < 6  
No Spilt LIGHT  
No Stray LIGHT





## Lighting Solutions

Beam angle adjustable from **6° to 50°**

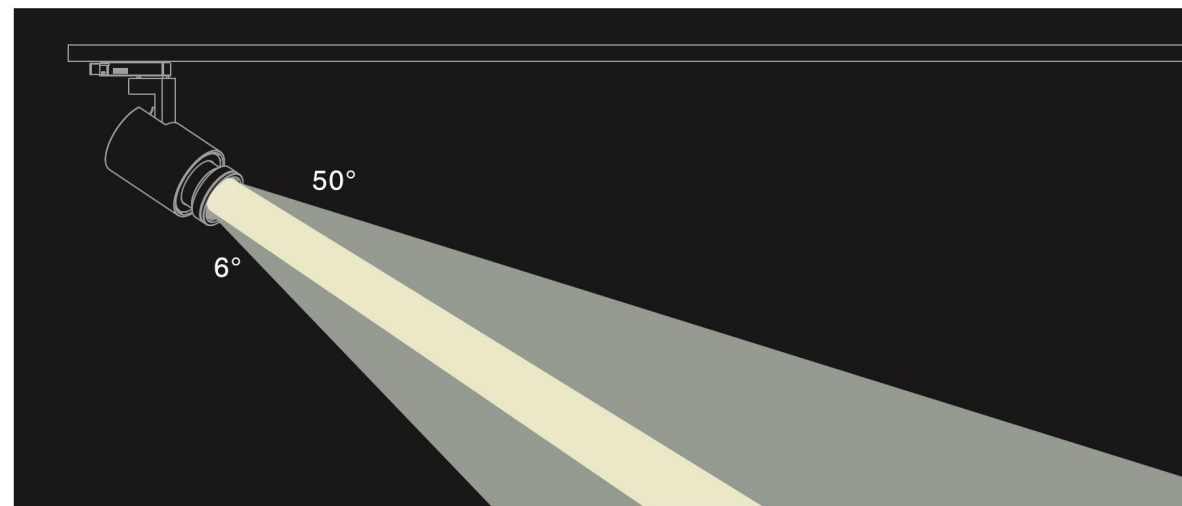

CREE COB	>80 lm/W	CRI 90+	CRI 80+	Dimmable	Dimmable 1-10V	Max 45°C -20°C	PF >0.90	0°-90°	0°-360°	6°-50°	10°-50°
-------------	-------------	------------	------------	----------	-------------------	----------------------	-------------	--------	---------	--------	---------

LED Type PHILIPS IP20 ●○ Black or white as standard **Sharp**

Power	CRI	Beam Angle	Luminous Flux	CCT	Frame	Model Number
10W	>90	15°	950lm	2700K	black	SHA10-B2715
			970lm	3000K	white	SHA10-W3015
			1050lm	4000K	black	SHA10-B4015
		24°	960lm	2700K	white	SHA10-W2724
			1000lm	3000K	black	SHA10-B3024
			1050lm	4000K	white	SHA10-W4024
		38°	960lm	2700K	black	SHA10-B2738
			1000lm	3000K	white	SHA10-W3038
			1050lm	4000K	black	SHA10-B4038
		60°	950lm	2700K	black	SHA10-B2760
			1000lm	3000K	white	SHA10-W3060
			1050lm	4000K	black	SHA10-B4060

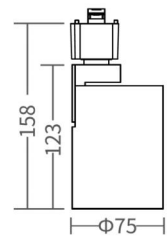

3-pin track adaptor

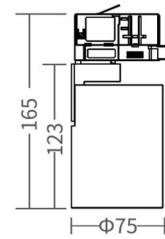

4-pin track adaptor

Angle

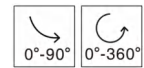

LED & Driver

Philips COB:  
 Power: 12W/LED  
 Voltage: 100-130V/220-240V  
 SDCM<5  
 Driver:  
 Input Voltage:100-277VAC  
 /220-240VAC  
 Output Current:700mA  
 Output Voltage:DC24-42V



G.W.:22kgs  
 Packaging:11.5x11x20.5cm,30PCS/CTN

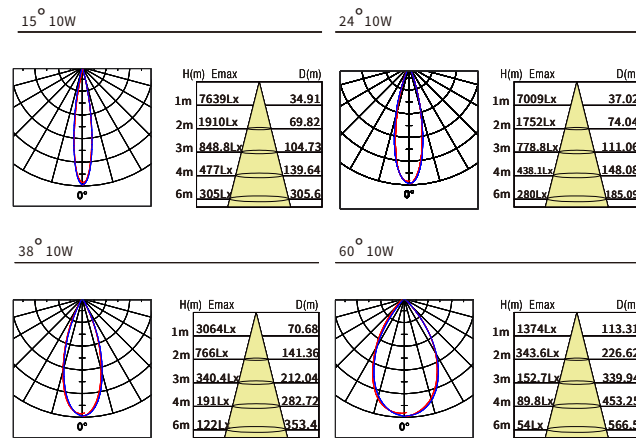

LED Type PHILIPS IP20 ●○ Black or white as standard **Sharp**

Power	CRI	Beam Angle	Luminous Flux	CCT	Frame	Model Number
15W	>90	15°	1400lm	2700K	black	SHA15-B2715
			1450lm	3000K	white	SHA15-W3015
			1500lm	4000K	black	SHA15-B4015
		24°	1400lm	2700K	white	SHA15-W2724
			1450lm	3000K	black	SHA15-B3024
			1500lm	4000K	white	SHA15-W4024
		38°	1400lm	2700K	black	SHA15-B2738
			1450lm	3000K	white	SHA15-W3038
			1500lm	4000K	black	SHA15-B4038
		60°	1400lm	2700K	black	SHA15-B2760
			1450lm	3000K	white	SHA15-W3060
			1500lm	4000K	black	SHA15-B4060

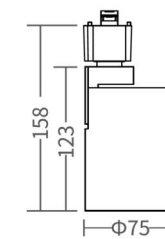
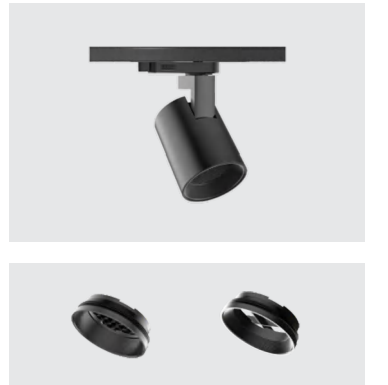

3-pin track adaptor

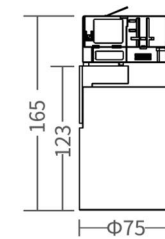

4-pin track adaptor

Angle

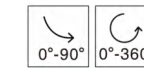

LED & Driver

Philips COB:  
 Power: 17W/LED  
 Voltage: 100-130V/220-240V  
 SDCM<5  
 Driver:  
 Input Voltage:100-277VAC  
 /220-240VAC  
 Output Current:350mA  
 Output Voltage:DC24-42V



G.W.:15.50kgs  
 Packaging:11.5x10x24.5cm,15PCS/CTN

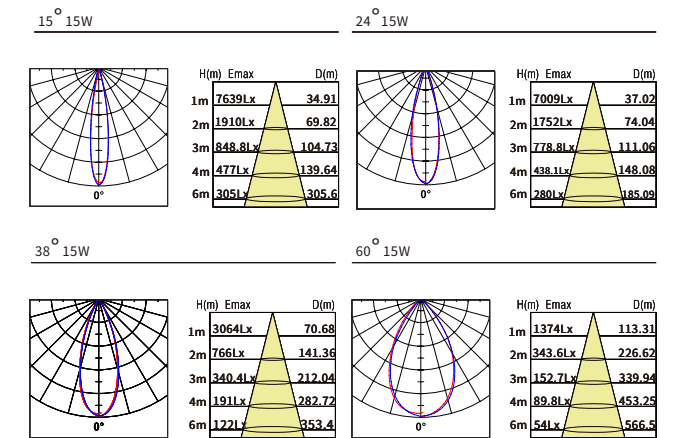

LED Type PHILIPS IP20 ●○ Black or white as standard

# Sharp

Power	CRI	Beam Angle	Luminous Flux	CCT	Frame	Model Number
20W	>90	15°	1900lm	2700K	black	SHA20-B2715
			1950lm	3000K	white	SHA20-W3015
			2000lm	4000K	black	SHA20-B4015
		24°	1900lm	2700K	white	SHA20-W2724
			1950lm	3000K	black	SHA20-B3024
			2000lm	4000K	white	SHA20-W4024
		38°	1900lm	2700K	black	SHA20-B2738
			1950lm	3000K	white	SHA20-W3038
			2000lm	4000K	black	SHA20-B4038
		60°	1900lm	2700K	black	SHA20-B2760
			1950lm	3000K	white	SHA20-W3060
			2000lm	4000K	black	SHA20-B4060

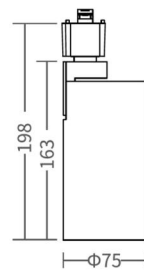

3-pin track adaptor

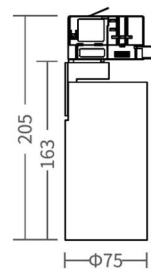

4-pin track adaptor

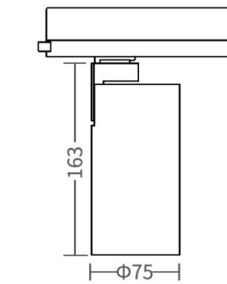

3-pin track adaptor/4-pin track adaptor

## Angle

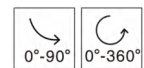

## LED & Driver

Philips COB:  
 Power: 22W/LED  
 Voltage: 100-130V/220-240V  
 SDCM<5  
 Driver:  
 Input Voltage:100-277VAC  
 /220-240VAC  
 Output Current:500mA  
 Output Voltage:DC24-42V  
 G.W.:15kgs  
 Packaging:28.5x24x11.5cm,12PCS/CTN

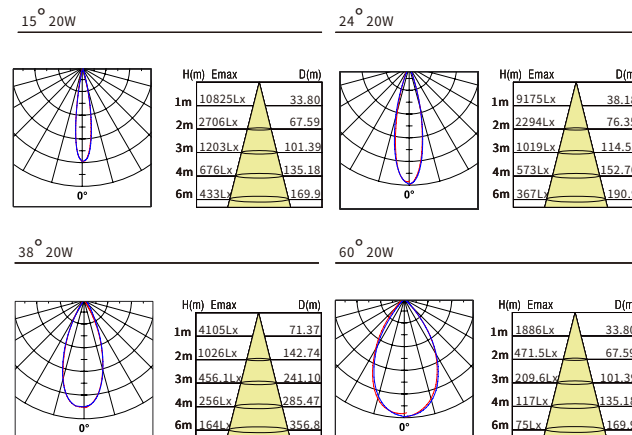

LED Type PHILIPS IP20 ●○ Black or white as standard

# Sharp

Power	CRI	Beam Angle	Luminous Flux	CCT	Frame	Model Number
30W	>90	15°	2700lm	2700K	black	SHA30-B2715
			2750lm	3000K	white	SHA30-W3015
			2800lm	4000K	black	SHA30-B4015
		24°	2700lm	2700K	white	SHA30-W2724
			2750lm	3000K	black	SHA30-B3024
			2800lm	4000K	white	SHA30-W4024
		38°	2700lm	2700K	black	SHA30-B2738
			2750lm	3000K	white	SHA30-W3038
			2800lm	4000K	black	SHA30-B4038
		60°	2700lm	2700K	black	SHA30-B2760
			2750lm	3000K	white	SHA30-W3060
			2800lm	4000K	black	SHA30-B4060

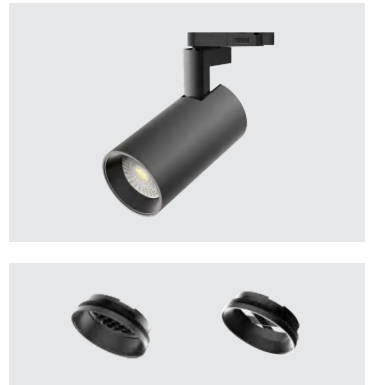

## Angle

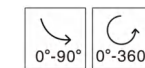

## LED & Driver

Philips COB:  
 Power: 32W/LED  
 Voltage: 100-130V/220-240V  
 SDCM<5  
 Driver:  
 Input Voltage:100-277VAC  
 /220-240VAC  
 Output Current:700mA  
 Output Voltage:DC24-42V  
 G.W.:15kgs  
 Packaging:28.5x24x11.5cm,12PCS/CTN

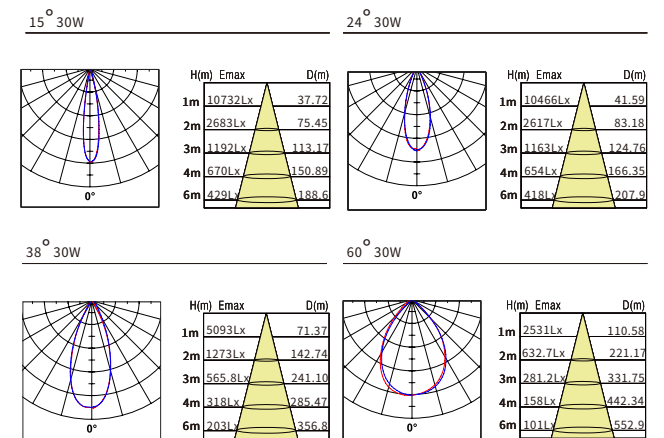



LED Type: PHILIPS IP20 ●○ Black or white as standard

Power	CRI	Beam Angle	Luminous Flux	CCT	Refractive screen	Frame	Model Number
10W	>90	6-50°	950lm	3000K	black	black	SHA10BEA-B30
			1000lm	4000K	black	white	SHA10BEA-W40
			1050lm	5000K	black	black	SHA10BEA-B50
		10-50°	950lm	3000K	black	white	SHA10BEA-W30
			1000lm	4000K	black	black	SHA10BEA-B40
			1050lm	5000K	black	white	SHA10BEA-W50

## Sharp Beaming

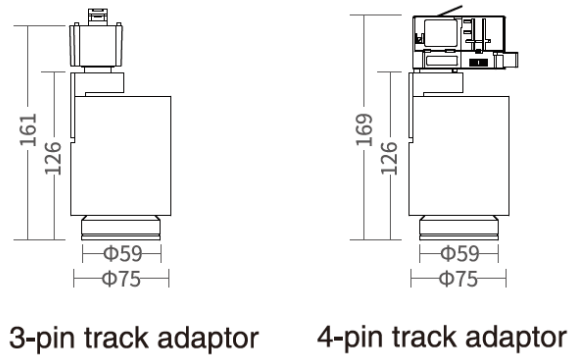
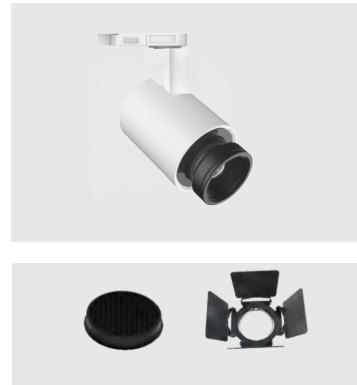

### Angle

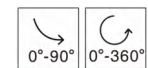

### LED & Driver

Philips COB:  
 Power: 12W/LED  
 Voltage: 100-130V/220-240V  
 SDCM<5  
 Driver:  
 Input Voltage: 100-277VAC /220-240VAC  
 Output Current: 700mA  
 Output Voltage: DC24-42V



G.W.: 17.6kgs  
 Packaging: 29.5x11.9x9.8cm, 15PCS/CTN

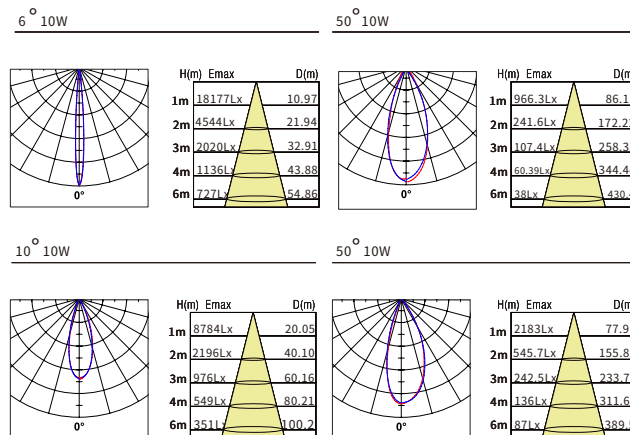

LED Type: PHILIPS IP20 ●○ Black or white as standard

Power	CRI	Beam Angle	Luminous Flux	CCT	Frame	Model Number
15W	>90	15°-70°	1400lm	3000K	black	SHA15BEA-B30
			1450lm	4000K	white	SHA15BEA-W40
			1500lm	5000K	black	SHA15BEA-B50
		15°-90°	1400lm	3000K	white	SHA15BEA-W30
			1450lm	4000K	black	SHA15BEA-B40
			1500lm	5000K	white	SHA15BEA-W50

## Sharp Beaming

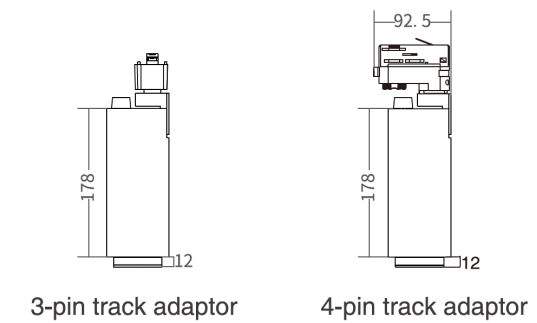

### Angle

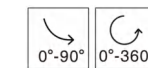

### LED & Driver

Philips COB:  
 Power: 17W/LED  
 Voltage: 100-130V/220-240V  
 SDCM<5  
 Driver:  
 Input Voltage: 100-277VAC /220-240VAC  
 Output Current: 350mA  
 Output Voltage: DC24-42V



G.W.: 17.1kgs  
 Packaging: 24x22.7x20cm, 20PCS/CTN

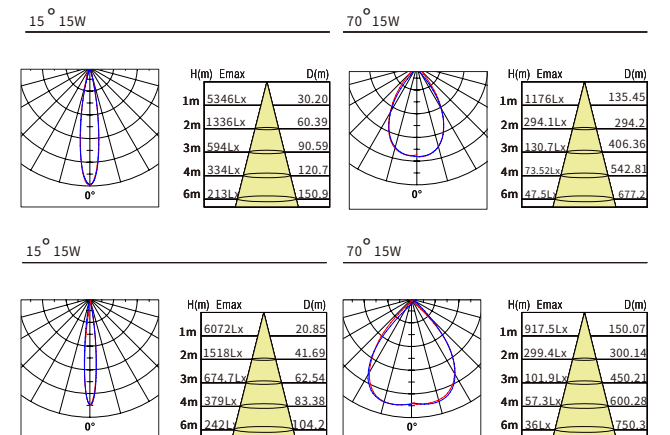

LED Type: PHILIPS IP20 ●○ Black or white as standard

Power	CRI	Beam Angle	Luminous Flux	CCT	Frame	Model Number
20W	>90	15-70°	1900lm	3000K	black	SHA20BEA-B30
			1950lm	4000K	white	SHA20BEA-W40
			2000lm	5000K	black	SHA20BEA-B50
		15-90°	1900lm	3000K	black	SHA20BEA-B30
			1950lm	4000K	white	SHA20BEA-W40
			2000lm	5000K	black	SHA20BEA-B50

## Sharp Beaming

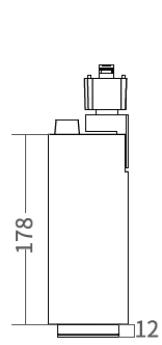

3-pin track adaptor

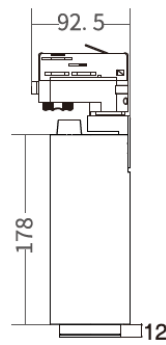

4-pin track adaptor

### Angle



### LED & Driver

Philips COB:  
 Power: 22W/LED  
 Voltage: 100-130V/220-240V  
 SDCM<5  
 Driver:  
 Input Voltage:100-277VAC  
 /220-240VAC  
 Output Current:500mA  
 Output Voltage:DC24-42V



G.W.:17.10kgs  
 Packaging:29.5x11.9x9.8cm,12PCS/CTN

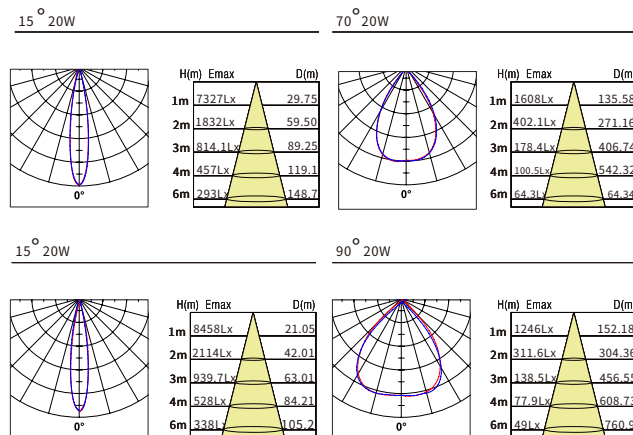

LED Type: PHILIPS IP20 ●○ Black or white as standard

Power	CRI	Beam Angle	Luminous Flux	CCT	Frame	Model Number
30W	>90	15-70°	2700lm	3000K	black	SHA30BEA-B30
			2750lm	4000K	white	SHA30BEA-W40
			2800lm	5000K	black	SHA30BEA-B50
		15-90°	2700lm	3000K	black	SHA30BEA-B30
			2750lm	4000K	white	SHA30BEA-W40
			2800lm	5000K	black	SHA30BEA-B50

## Sharp Beaming

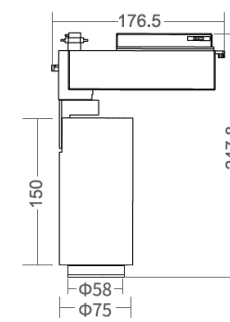

3-pin track adaptor

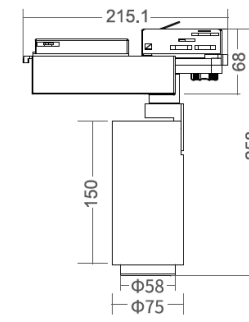

4-pin track adaptor

### Angle

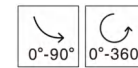

### LED & Driver

Philips COB:  
 Power: 32W/LED  
 Voltage: 100-130V/220-240V  
 SDCM<5  
 Driver:  
 Input Voltage:100-277VAC  
 /220-240VAC  
 Output Current:700mA  
 Output Voltage:DC24-42V



G.W.:17.10kgs  
 Packaging:24x22.7x11cm,10PCS/CTN

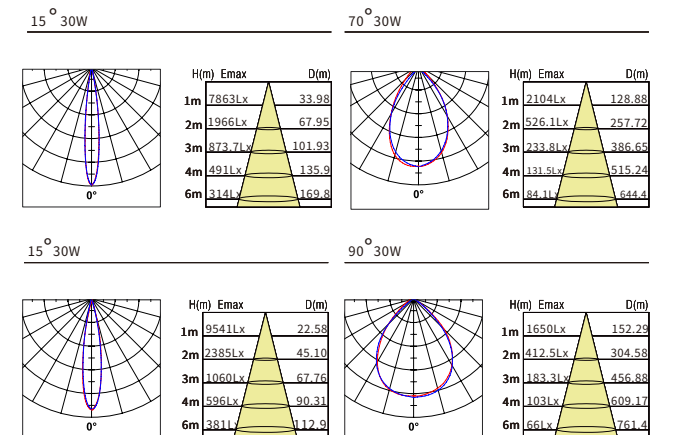

LED Type: PHILIPS IP20 ●○ Black or white as standard



Power	CRI	Beam Angle	Luminous Flux	CCT	Frame	Model Number
20W	>90	3-30°	600lm	3000K	black	SHA20PRO-B30
			650lm	4000K	white	SHA20PRO-W40
			700lm	5000K	black	SHA20PRO-B50

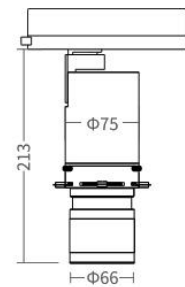

3-pin track adaptor/4-pin track adaptor

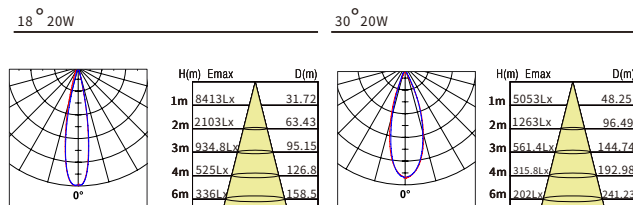

Angle



LED & Driver

Philips COB:  
 Power: 22W/LED  
 Voltage: 100-130V/220-240V  
 SDCM<5  
 Driver:  
 Input Voltage: 100-277VAC /220-240VAC  
 Output Current: 500mA  
 Output Voltage: DC24-42V



Logo Filter

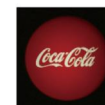

Colour Filter



G.W.: 19kgs  
 Packaging: 28.4x24x11.5cm, 12PCS/CTN



LED Type: PHILIPS IP20 ●○ Black or white as standard



Power	CRI	Beam Angle	Luminous Flux	CCT	Refractive screen	Frame	Model Number
25W	>90	3°-30°	700lm	3000K	black	black	SHA25PRO-B30
			750lm	4000K	white	white	SHA25PRO-W40
			800lm	5000K	black	black	SHA25PRO-B50

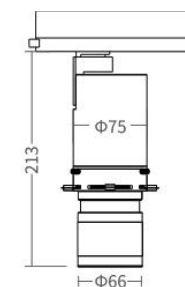

3-pin track adaptor/4-pin track adaptor

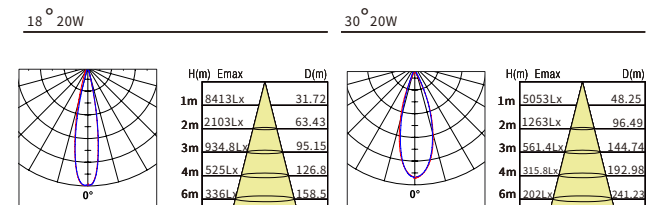

Angle

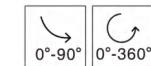

LED & Driver

Philips COB:  
 Power: 27W/LED  
 Voltage: 100-130V/220-240V  
 SDCM<5  
 Driver:  
 Input Voltage: 100-277VAC /220-240VAC  
 Output Current: 500mA  
 Output Voltage: DC24-42V



Logo Filter



Colour Filter



G.W.: 19kgs  
 Packaging: 28.4x24x11.5cm, 12PCS/CTN





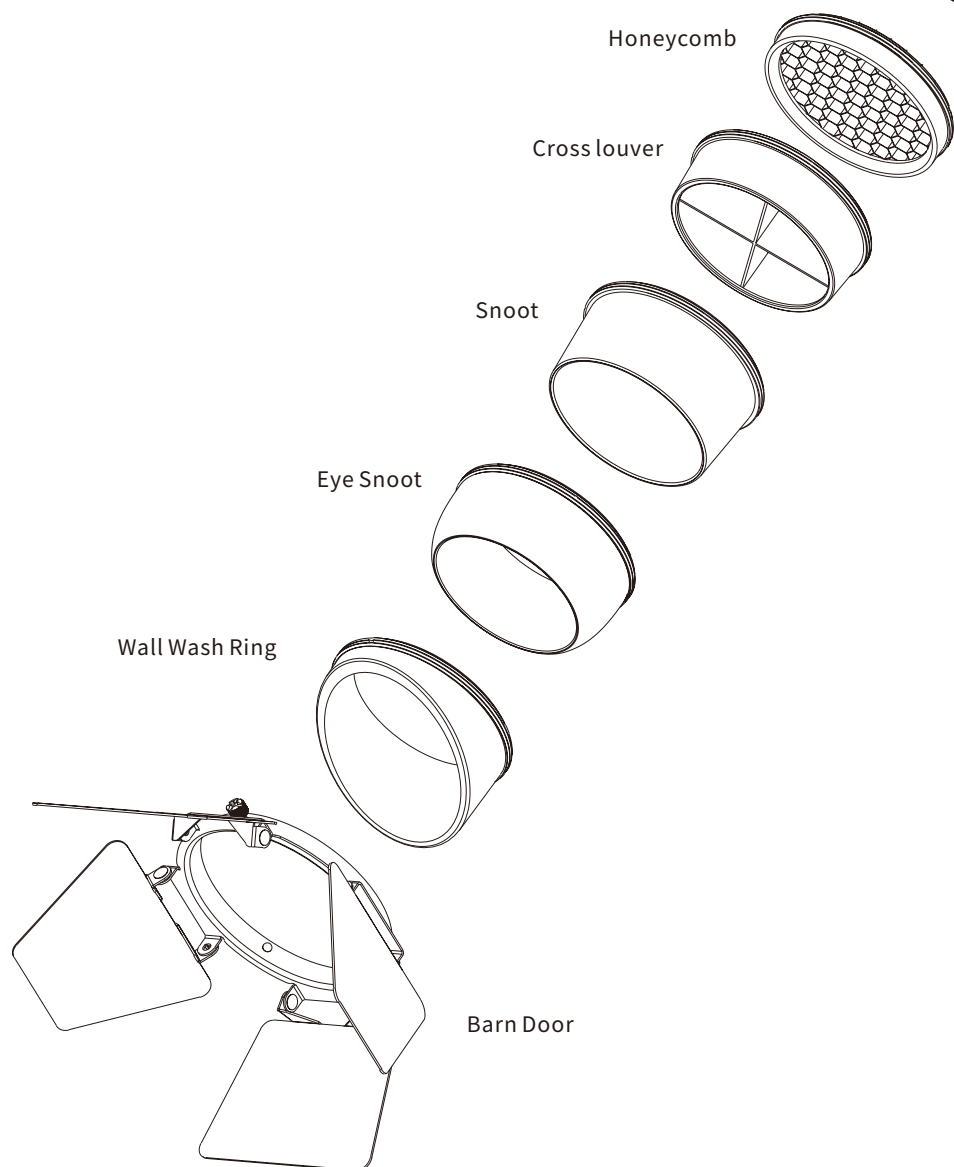
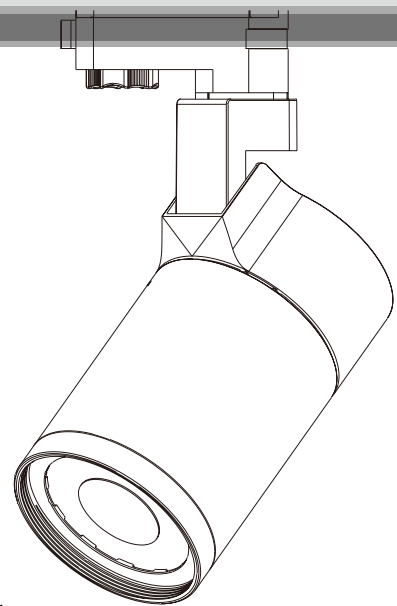

# Unico

# Excellent Modular Combination Concept

Mounted Base:

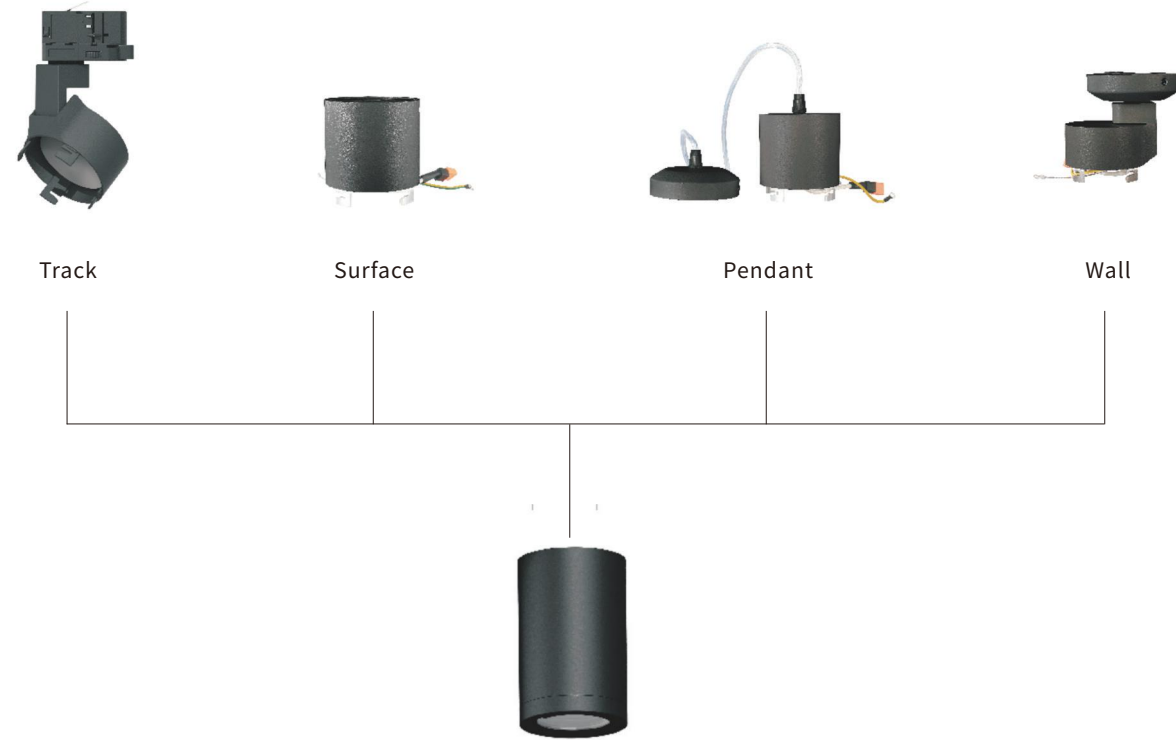

Narrow Beam Light Engine

Mounted:



## 8 Different light shapes:

Simply adding extra optical accessories, the light shape can be changed to big circle, square, rectangular, line.....

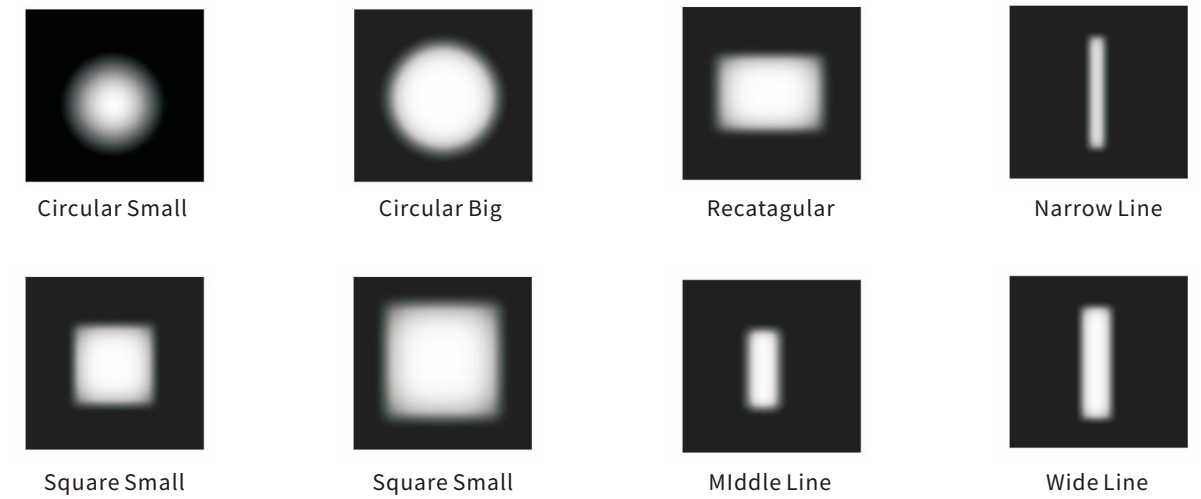



Unico  
10W,15W



Unico  
20W,25W,30W

Optical Accessories



Honeycomb Filter    Cross Louver    Barn Door

Optical Accessories



Barn Door    Wall Wash Ring    Honeycomb Filter    Eye Snoot    Cross Louver    Snoot



LED Type: CREE IP20  
 ○ ● White as standard

Power	CRI	BeamAngle	Luminous Flux	CCT	Refractive screen	Frame	Model Number
10W	>90	6°	450lm	2700K	white	white	UNISUS10-W2706
			450lm	3000K	white	white	UNISUS10-W3006
			450lm	4000K	white	white	UNISUS10-W4006
			450lm	2700K	balck	balck	UNISUS10-B2706
			450lm	3000K	balck	balck	UNISUS10-B3006
			450lm	4000K	balck	balck	UNISUS10-B4006

## Unico Suspension

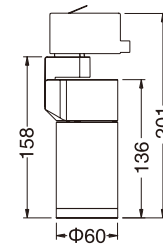
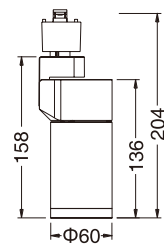

(mm)

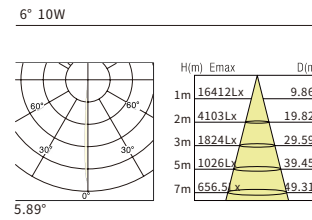

### LED & Driver

CREE COB:  
 Power: 11W/LED  
 Voltage: 36V  
 SDCM<3  
 Tridonic Driver  
 Input voltage:100-240VAC  
 /220-240V/110-130V  
 Output current:700mA  
 Output voltage:DC16-38V



LED Type: CREE IP20  
 ○ ● White as standard

Power	CRI	BeamAngle	Luminous Flux	CCT	Refractive screen	Frame	Model Number
10W	>90	6°	450lm	2700K	white	white	UNIW10-W2706
			450lm	3000K	white	white	UNIW10-W3006
			450lm	4000K	white	white	UNIW10-W4006
			450lm	2700K	balck	balck	UNIW10-B2706
			450lm	3000K	balck	balck	UNIW10-B3006
			450lm	4000K	balck	balck	UNIW10-B4006

## Unico Wall

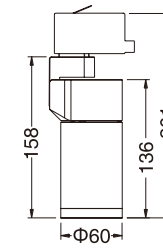
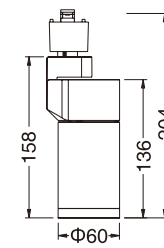

(mm)

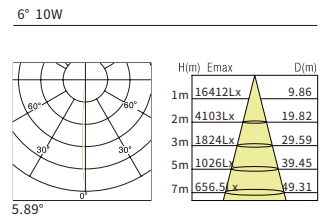

### LED & Driver

CREE COB:  
 Power: 11W/LED  
 Voltage: 36V  
 SDCM<3  
 Tridonic Driver  
 Input voltage:100-240VAC  
 /220-240V/110-130V  
 Output current:700mA  
 Output voltage:DC16-38V



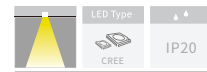

○ ● White as standard

### Unico Track

Power	CRI	BeamAngle	Luminous Flux	CCT	Refractive screen	Frame	Model Number
10W	>90	6°	450lm	2700K	white	white	UNIT10-W2706
			450lm	3000K	white	white	UNIT10-W3006
			450lm	4000K	white	white	UNIT10-W4006
			450lm	2700K	balck	balck	UNIT10-B2706
			450lm	3000K	balck	balck	UNIT10-B3006
			450lm	4000K	balck	balck	UNIT10-B4006

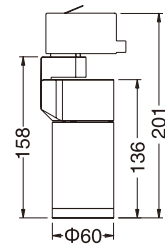
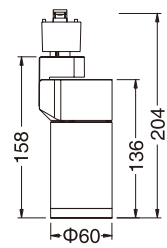

(mm)

6° 10W

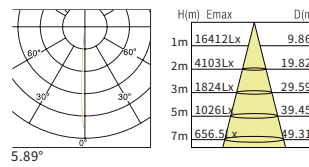

#### LED & Driver

CREE COB:  
Power: 11W/LED  
Voltage: 36V  
SDCM< 3  
Tridonic Driver:  
Input voltage:100-240VAC  
/220-240V/110-130V  
Output current:700mA  
Output voltage:DC16-38V

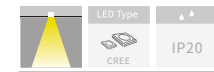

○ ● White as standard

### Unico Surface

Power	CRI	BeamAngle	Luminous Flux	CCT	Refractive screen	Frame	Model Number
10W	>90	6°	450lm	2700K	white	white	UNISUR10-W2706
			450lm	3000K	white	white	UNISUR10-W3006
			450lm	4000K	white	white	UNISUR10-W4006
			450lm	2700K	balck	balck	UNISUR10-B2706
			450lm	3000K	balck	balck	UNISUR10-B3006
			450lm	4000K	balck	balck	UNISUR10-B4006

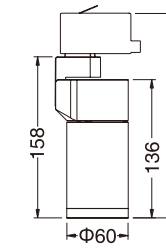
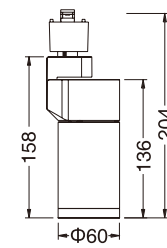

(mm)

6° 10W

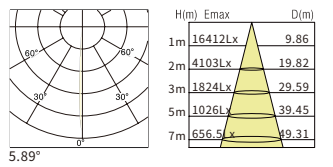

#### LED & Driver

CREE COB:  
Power: 11W/LED  
Voltage: 36V  
SDCM< 3  
Tridonic Driver:  
Input voltage:100-240VAC  
/220-240V/110-130V  
Output current:700mA  
Output voltage:DC16-38V



LED Type: Luminus IP20 White as standard **Unico**

Power	CRI	BeamAngle	Luminous Flux	CCT	Refractive screen	Frame	Model Number
10W	>90	12°	850lm	2700K	balck	balck	UNIT10-B2712
			850lm	3000K	white	white	UNIT10-W3012
			850lm	4000K	white	white	UNIT10-W4012
		24°	850lm	2700K	white	white	UNIT10-W2724
			850lm	3000K	balck	balck	UNIT10-B3024
			850lm	4000K	white	white	UNIT10-W4024
38°	850lm	2700K	white	white	UNIT10-W2738		
	850lm	3000K	white	white	UNIT10-W3038		
	850lm	4000K	balck	balck	UNIT10-B4038		
60°	850lm	2700K	balck	balck	UNIT10-B2760		
	850lm	3000K	balck	balck	UNIT10-B3060		
	850lm	4000K	white	white	UNIT10-W4060		

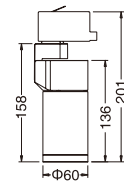
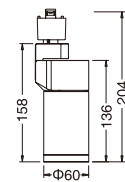

(mm)

Optical Parameters



Track Surface Suspension Wall

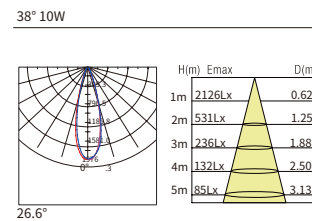
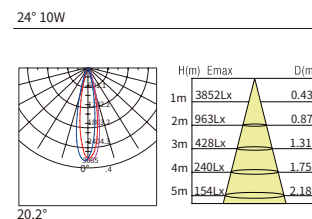
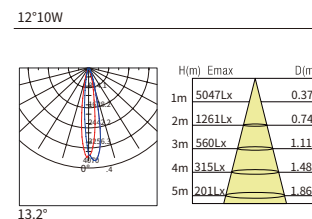

LED & Driver

Luminus COB:  
 Power: 11W/LED  
 Voltage: 36V  
 SDCM<3  
 Tridonic Driver  
 Input voltage:100-240VAC  
 /220-240V/110-130V  
 Output current:250mA  
 Output voltage:DC16-38V



LED Type: Luminus IP20 White as standard **Unico**

Power	CRI	BeamAngle	Luminous Flux	CCT	Refractive screen	Frame	Model Number
15W	>90	12°	1200lm	2700K	balck	balck	UNIT15-B2712
			1200lm	3000K	white	white	UNIT15-W3012
			1200lm	4000K	white	white	UNIT15-W4012
		24°	1200lm	2700K	white	white	UNIT15-W2724
			1200lm	3000K	balck	balck	UNIT15-B3024
			1200lm	4000K	white	white	UNIT15-W4024
38°	1200lm	2700K	white	white	UNIT15-W2738		
	1200lm	3000K	white	white	UNIT15-W3038		
	1200lm	4000K	balck	balck	UNIT15-B4038		
60°	1200lm	2700K	balck	balck	UNIT15-B2760		
	1200lm	3000K	balck	balck	UNIT15-B3060		
	1200lm	4000K	white	white	UNIT15-W4060		

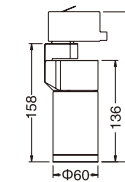
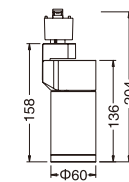

(mm)

Optical Parameters



Track Surface Suspension Wall

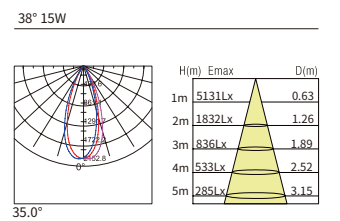
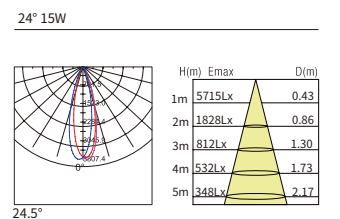
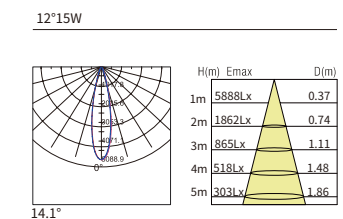

LED & Driver

Luminus COB:  
 Power: 11W/LED  
 Voltage: 36V  
 SDCM<3  
 Tridonic Driver:  
 Input voltage:100-240VAC  
 /220-240V/110-130V  
 Output current:350mA  
 Output voltage:DC16-42V





LED Type: Luminus IP20 White as standard **Unico**

Power	CRI	BeamAngle	Luminous Flux	CCT	Refractive screen	Frame	Model Number
20W	>90	12°	2000lm	2700K	balck	balck	UNIT20-B2712
			2000lm	3000K	white	white	UNIT20-W3012
			2000lm	4000K	white	white	UNIT20-W4012
		24°	2000lm	2700K	white	white	UNIT20-W2724
			2000lm	3000K	balck	balck	UNIT20-B3024
			2000lm	4000K	white	white	UNIT20-W4024
		38°	2000lm	2700K	white	white	UNIT20-W2738
			2000lm	3000K	white	white	UNIT20-W3038
			2000lm	4000K	balck	balck	UNIT20-B4038
		60°	2000lm	2700K	balck	balck	UNIT20-B2760
			2000lm	3000K	balck	balck	UNIT20-B3060
			2000lm	4000K	white	white	UNIT20-W4060

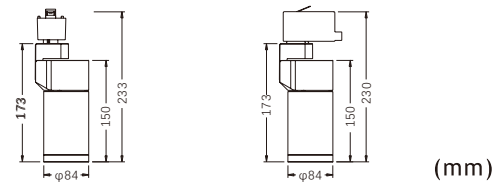

Optical Parameters



Track Surface Suspension Wall

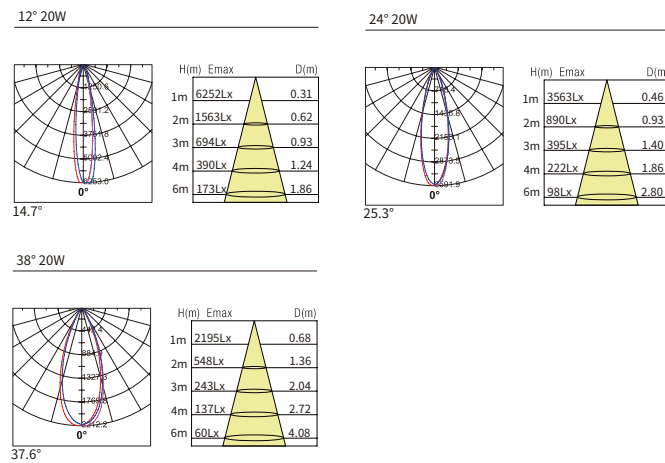

LED & Driver

Luminus COB  
 Power: 21W/LED  
 Voltage: 36V  
 SDCM<3  
 Tridonic Driver:  
 Input voltage:100-240VAC  
 /220-240V/110-130V  
 Output current:520mA  
 Output voltage:DC16-42V



LED Type: Luminus IP20 White as standard **Unico**

Power	CRI	BeamAngle	Luminous Flux	CCT	Refractive screen	Frame	Model Number
25W	>90	12°	2700lm	2700K	balck	balck	UNIT25-B2712
			2700lm	3000K	white	white	UNIT25-W3012
			2700lm	4000K	white	white	UNIT25-W4012
		24°	2700lm	2700K	white	white	UNIT25-W2724
			2700lm	3000K	balck	balck	UNIT25-B3024
			2700lm	4000K	white	white	UNIT25-W4024
		38°	2700lm	2700K	white	white	UNIT25-W2738
			2700lm	3000K	white	white	UNIT25-W3038
			2700lm	4000K	balck	balck	UNIT25-B4038
		60°	2700lm	2700K	balck	balck	UNIT25-B2760
			2700lm	3000K	balck	balck	UNIT25-B3060
			2700lm	4000K	white	white	UNIT25-W4060

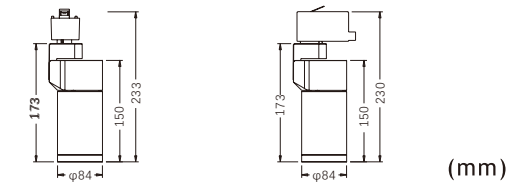

Optical Parameters



Track Surface Suspension Wall

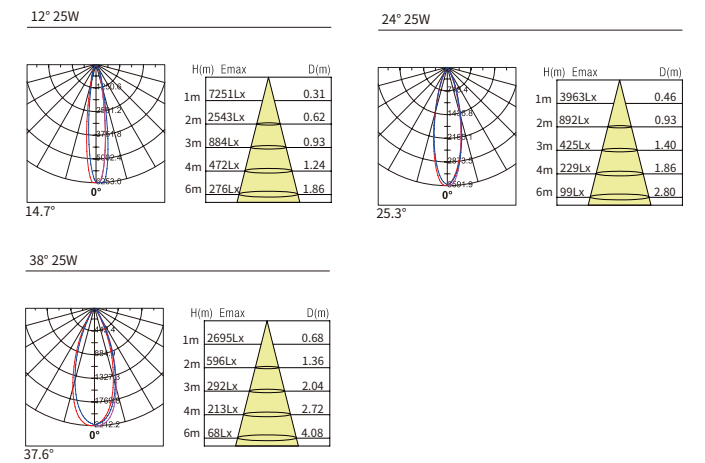

LED & Driver

Luminus COB  
 Power: 27W/LED  
 Voltage: 36V  
 SDCM<3  
 Tridonic Driver:  
 Input voltage:100-240VAC  
 /220-240V/110-130V  
 Output current:600mA  
 Output voltage:DC16-42V



LED Type: CREE IP20 White as standard **Unico**

Power	CRI	BeamAngle	Luminous Flux	CCT	Refractive screen	Frame	Model Number
10W	>90	Zoomable 15°-45°	630lm	2700K	white	white	UNIT10-W27ZO
			630lm	3000K	white	white	UNIT10-W30ZO
			630lm	4000K	white	white	UNIT10-W40ZO
			630lm	2700K	balck	balck	UNIT10-B27ZO
			630lm	3000K	balck	balck	UNIT10-B30ZO
			630lm	4000K	balck	balck	UNIT10-B40ZO

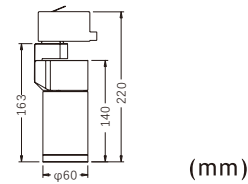
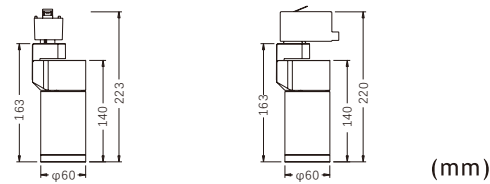

Optical Parameters



Track Surface Suspension Wall

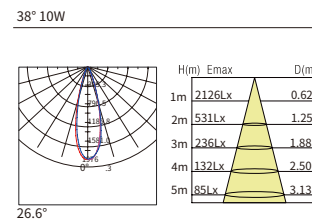
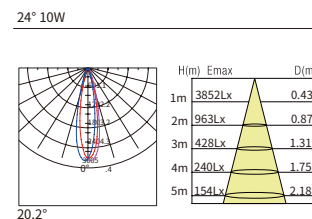
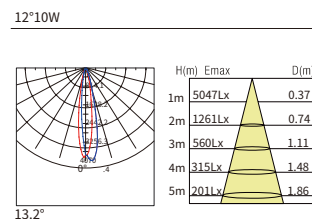

LED & Driver

Luminus COB:  
 Power: 11W/LED  
 Voltage: 36V  
 SDCM<3  
 Tridonic Driver  
 Input voltage:100-240VAC  
 /220-240V/110-130V  
 Output current:250mA  
 Output voltage:DC16-38V



LED Type: CREE IP20 White as standard **Unico**

Power	CRI	BeamAngle	Luminous Flux	CCT	Refractive screen	Frame	Model Number
15W	>90	Zoomable 15°-45°	1150lm	2700K	white	white	UNI15T-W27ZO
			1150lm	3000K	white	white	UNI15T-W30ZO
			1150lm	4000K	white	white	UNI15T-W40ZO
			1150lm	2700K	balck	balck	UNI15T-B27ZO
			1150lm	3000K	balck	balck	UNI15T-B30ZO
			1150lm	4000K	balck	balck	UNI15T-B40ZO

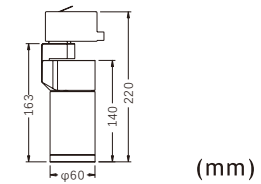
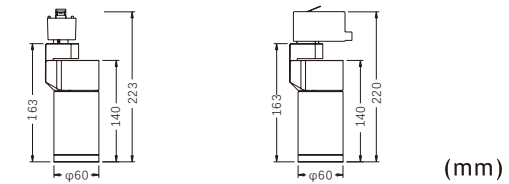

Optical Parameters



Track Surface Suspension Wall

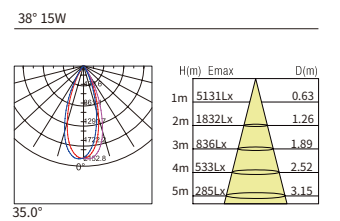
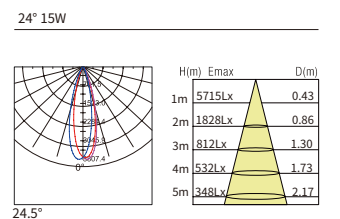
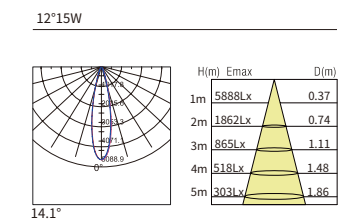

LED & Driver

Luminus COB:  
 Power: 11W/LED  
 Voltage: 36V  
 SDCM<3  
 Tridonic Driver:  
 Input voltage:100-240VAC  
 /220-240V/110-130V  
 Output current:350mA  
 Output voltage:DC16-42V



LED Type: CREE IP20 White as standard **Unico**

Power	CRI	BeamAngle	Luminous Flux	CCT	Refractive screen	Frame	Model Number
20W	>90	Zoomable 15°-45°	1650lm	2700K	white	white	UNIT20-W27ZO
			1650lm	3000K	white	white	UNIT20-W30ZO
			1650lm	4000K	white	white	UNIT20-W40ZO
			1650lm	2700K	balck	balck	UNIT20-B27ZO
			1650lm	3000K	balck	balck	UNIT20-B30ZO
			1650lm	4000K	balck	balck	UNIT20-B40ZO

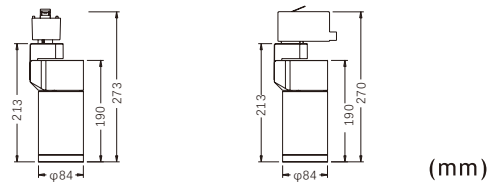

(mm)

Optical Parameters



Track Surface Suspension Wall

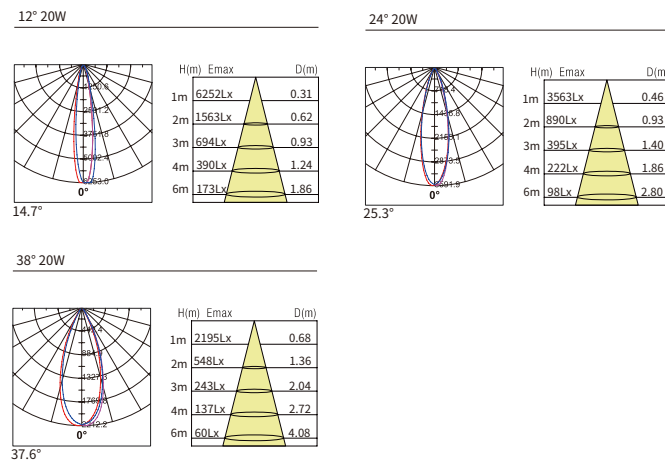

LED & Driver

Luminus COB  
 Power: 21W/LED  
 Voltage: 36V  
 SDCM<3  
 Tridonic Driver:  
 Input voltage:100-240VAC  
 /220-240V/110-130V  
 Output current:520mA  
 Output voltage:DC16-42V



LED Type: CREE IP20 White as standard **Unico**

Power	CRI	BeamAngle	Luminous Flux	CCT	Refractive screen	Frame	Model Number
25W	>90	Zoomable 15°-45°	1850lm	2700K	white	white	UNIT25-W27ZO
			1850lm	3000K	white	white	UNIT25-W30ZO
			1850lm	4000K	white	white	UNIT25-W40ZO
			1850lm	2700K	balck	balck	UNIT25-B27ZO
			1850lm	3000K	balck	balck	UNIT25-B30ZO
			1850lm	4000K	balck	balck	UNIT25-B40ZO

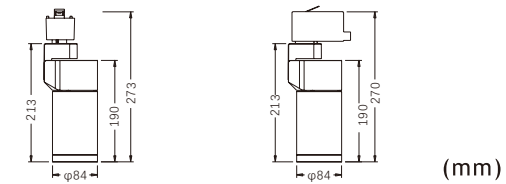

(mm)

Optical Parameters



Track Surface Suspension Wall

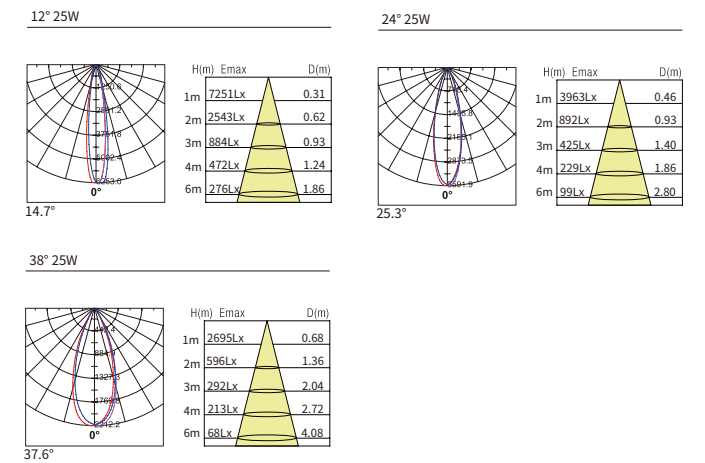

LED & Driver

Luminus COB  
 Power: 27W/LED  
 Voltage: 36V  
 SDCM<3  
 Tridonic Driver:  
 Input voltage:100-240VAC  
 /220-240V/110-130V  
 Output current:600mA  
 Output voltage:DC16-42V





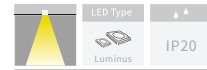

○ ● White as standard

# Unico

Power	CRI	Beam Angle	Luminous Flux	CCT	Refractive screen	Frame	Model Number
30W	>90	12°	2900lm	2700K	balck	balck	UNIT30-B2712
			2900lm	3000K	white	white	UNIT30-W3012
			2900lm	4000K	white	white	UNIT30-W4012
		24°	2900lm	2700K	white	white	UNIT30-W2724
			2900lm	3000K	balck	balck	UNIT30-B3024
			2900lm	4000K	white	white	UNIT30-W4024
38°	2900lm	2700K	white	white	UNIT30-W2738		
	2900lm	3000K	white	white	UNIT30-W3038		
	2900lm	4000K	balck	balck	UNIT30-B4038		
60°	2900lm	2700K	balck	balck	UNIT30-B2760		
	2900lm	3000K	balck	balck	UNIT30-B3060		
	2900lm	4000K	white	white	UNIT30-W4060		

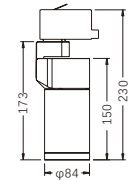
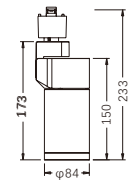

(mm)

## Optical Parameters



Track Surface Suspension Wall

12° 30W

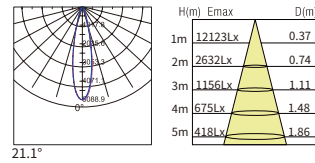

24° 30W

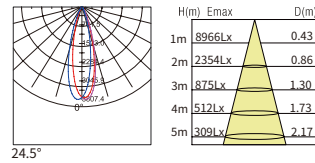

38° 30W

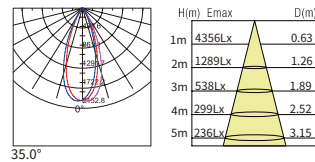

## LED & Driver

Luminus COB  
 Power: 32W/LED  
 Voltage: 36V  
 SDCM<3  
 Tridonic Driver:  
 Input voltage:100-240VAC  
 /220-240V/110-130V  
 Output current:730mA  
 Output voltage:DC16-45V







○ ● White as standard

# Unico

Power	CRI	BeamAngle	Luminous Flux	CCT	Refractive screen	Frame	Model Number
30W	>90	Zoomable 15°-45°	2400lm	2700K	white	white	UNIT30-W27ZO
			2400lm	3000K	white	white	UNIT30-W30ZO
			2400lm	4000K	white	white	UNIT30-W40ZO
			2400lm	2700K	balck	balck	UNIT30-B27ZO
			2400lm	3000K	balck	balck	UNIT30-B30ZO
			2400lm	4000K	balck	balck	UNIT30-B40ZO

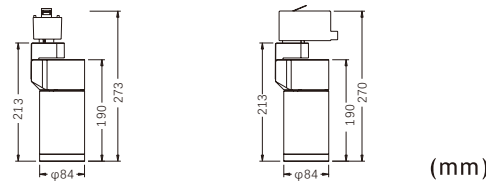

## Optical Parameters

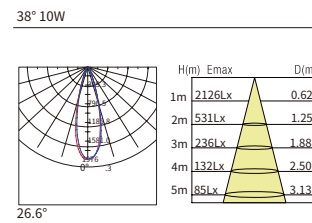
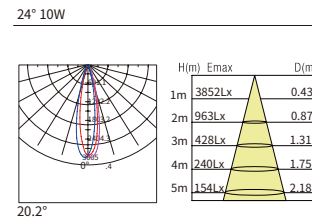
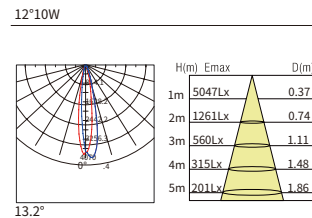

## LED & Driver

Luminus COB  
 Power: 32W/LED  
 Voltage: 36V  
 SDCM<3  
 Tridonic Driver:  
 Input voltage:100-240VAC  
 /220-240V/110-130V  
 Output current:730mA  
 Output voltage:DC16-45V





#### DIFFERENT MOUNTING TYPES

surface mounted downlight  
half recessed mounted  
track mounting  
recessed & stretchable mounted  
surface & stretchable mounted

# Magic



LED Type: CREE XPE, IP20, White as standard

### Magic Suspension

Power	CRI	Beam Angle	Luminous Flux	CCT	Refractive screen	Frame	Model Number
5W	>90	15°	300lm	2700K	balck	white	MAGSUS05-W2715
			320lm	3000K	balck	white	MAGSUS05-W3015
			350lm	4000K	balck	white	MAGSUS05-W4015
		24°	300lm	2700K	balck	white	MAGSUS05-W2724
			320lm	3000K	balck	white	MAGSUS05-W3024
			350lm	4000K	balck	white	MAGSUS05-W4024
		36°	300lm	2700K	balck	white	MAGSUS05-W2736
			320lm	3000K	balck	white	MAGSUS05-W3036
			350lm	4000K	balck	white	MAGSUS05-W4036

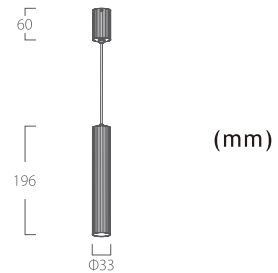
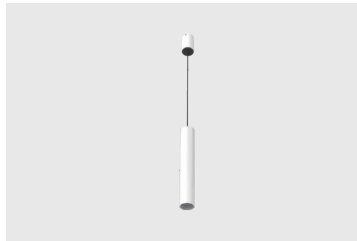

#### HOUSING IN DIFFERENT COLOR



#### LED & Driver

CREE XPE  
 Power: 7W/LED  
 Voltage: 3V  
 SDCM<5  
 KEGU Driver:  
 Input voltage:100-240VAC  
 /220-240V/110-130V  
 Output current:700mA  
 Output voltage:DC3V



LED Type: LMHILEDS 9050, IP20, White as standard

### Magic Suspension

Power	CRI	Beam Angle	Luminous Flux	CCT	Refractive screen	Frame	Model Number		
10W	>90	15°	570lm	2700K	balck	white	MAGSUS10-W2715		
			600lm	3000K	balck	white	MAGSUS10-W3015		
			620lm	4000K	balck	white	MAGSUS10-W4015		
			570lm	2700K	balck	white	MAGSUS10-W2724		
			600lm	3000K	balck	white	MAGSUS10-W3024		
		24°	570lm	2700K	balck	white	MAGSUS10-W2724		
			600lm	3000K	balck	white	MAGSUS10-W3024		
			620lm	4000K	balck	white	MAGSUS10-W4024		
			570lm	2700K	balck	white	MAGSUS10-W2736		
			600lm	3000K	balck	white	MAGSUS10-W3036		
		36°	570lm	2700K	balck	white	MAGSUS10-W2736		
			600lm	3000K	balck	white	MAGSUS10-W3036		
			620lm	4000K	balck	white	MAGSUS10-W4036		
			Zoomable 15°-36°		570lm	2700K	balck	white	MAGSUS10-W2720
			Zoomable 15°-36°		600lm	3000K	balck	white	MAGSUS10-W3020
Zoomable 15°-36°		620lm	4000K	balck	white	MAGSUS10-W4020			

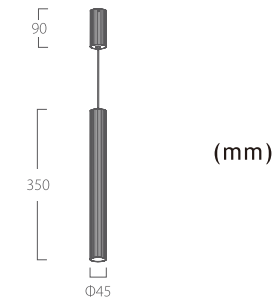
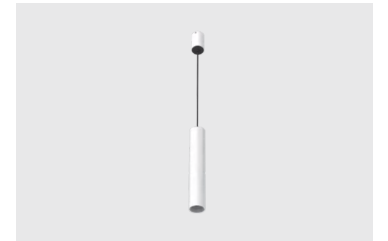

#### HOUSING IN DIFFERENT COLOR



#### LED & Driver

CREE XPE  
 Power: 12W/LED  
 Voltage: 24V  
 SDCM<5  
 KEGU Driver:  
 Input voltage:100-240VAC  
 /220-240V/110-130V  
 Output current:200mA  
 Output voltage:DC24V

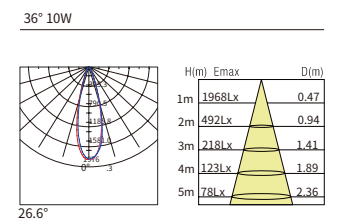
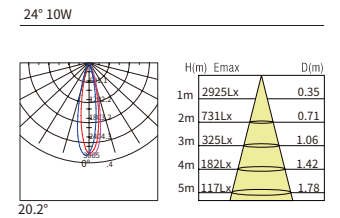
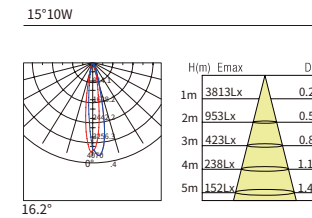
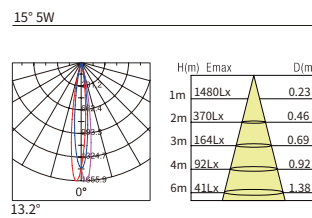

## Magic Suspension

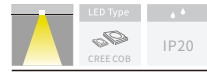

White as standard



Power	CRI	Beam Angle	Luminous Flux	CCT	Refractive screen	Frame	Model Number
16W	>90	15°	940lm	2700K	balck	white	MAGSUS16-W2715
			960lm	3000K	balck	white	MAGSUS16-W3015
			980lm	4000K	balck	white	MAGSUS16-W4015
		24°	940lm	2700K	balck	white	MAGSUS16-W2724
			960lm	3000K	balck	white	MAGSUS16-W3024
			980lm	4000K	balck	white	MAGSUS16-W4024
		36°	940lm	2700K	balck	white	MAGSUS16-W2736
			960lm	3000K	balck	white	MAGSUS16-W3036
			980lm	4000K	balck	white	MAGSUS16-W4036
Zoomable 15°-36°	940lm	2700K	balck	white	MAGSUS16-W27Z0		
	960lm	3000K	balck	white	MAGSUS16-W30Z0		
	980lm	4000K	balck	white	MAGSUS16-W40Z0		

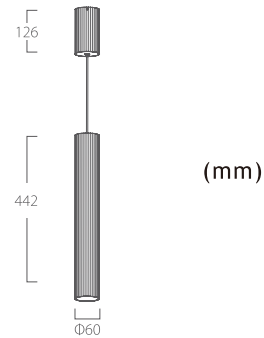

### HOUSING IN DIFFERENT COLOR

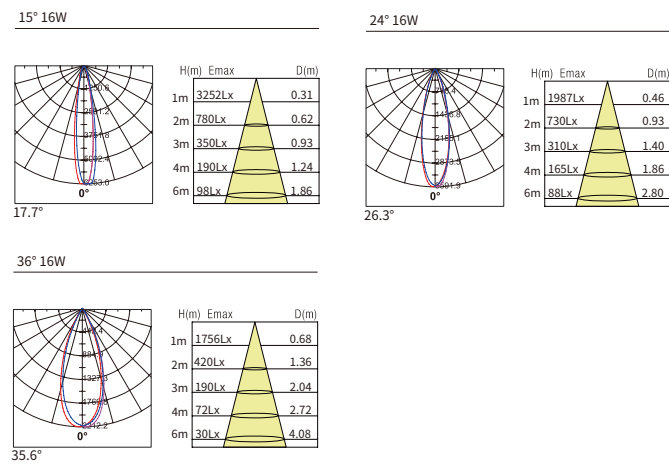

### LED & Driver

CREE XPE  
 Power: 18W/LED  
 Voltage: 36V  
 SDCM<5  
 MEANWELL Driver:  
 Input voltage:100-240VAC  
 /220-240V/110-130V  
 Output current:450mA  
 Output voltage:DC36V



LED Type: LUMILEDS 5050  
IP20  
White as standard

### Magic Ceiling

Power	CRI	BeamAngle	Luminous Flux	CCT	Refractive screen	Frame	Model Number
10W	>90	15°	570lm	2700K	balck	white	MAGC10-W2715
			600lm	3000K	balck	white	MAGC10-W3015
			620lm	4000K	balck	white	MAGC10-W4015
		24°	570lm	2700K	balck	white	MAGC10-W2724
			600lm	3000K	balck	white	MAGC10-W3024
			620lm	4000K	balck	white	MAGC10-W4024
36°	570lm	2700K	balck	white	MAGC10-W2736		
	600lm	3000K	balck	white	MAGC10-W3036		
	620lm	4000K	balck	white	MAGC10-W4036		
Zoomable 15°-36°	>90	Zoomable 15°-36°	570lm	2700K	balck	white	MAGC10-W27ZO
			600lm	3000K	balck	white	MAGC10-W30ZO
			620lm	4000K	balck	white	MAGC10-W40ZO

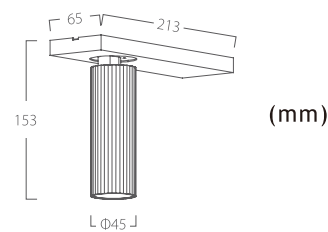

#### HOUSING IN DIFFERENT COLOR

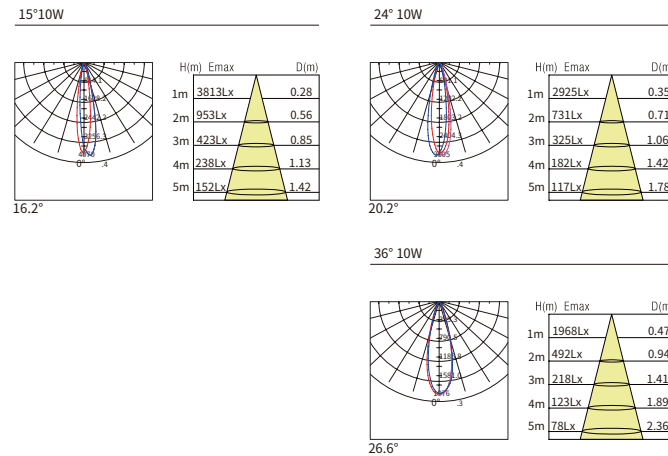

#### LED & Driver

CREE XPE  
Power: 12W/LED  
Voltage: 24V  
SDCM<5  
KEGU Driver:  
Input voltage:100-240VAC  
/220-240V/110-130V  
Output current:200mA  
Output voltage:DC24V



LED Type: CREE COB  
IP20  
White as standard

### Magic Ceiling

Power	CRI	BeamAngle	Luminous Flux	CCT	Refractive screen	Frame	Model Number
16W	>90	15°	940lm	2700K	balck	white	MAGC16-W2715
			960lm	3000K	balck	white	MAGC16-W3015
			980lm	4000K	balck	white	MAGC16-W4015
		24°	940lm	2700K	balck	white	MAGC16-W2724
			960lm	3000K	balck	white	MAGC16-W3024
			980lm	4000K	balck	white	MAGC16-W4024
36°	940lm	2700K	balck	white	MAGC16-W2736		
	960lm	3000K	balck	white	MAGC16-W3036		
	980lm	4000K	balck	white	MAGC16-W4036		
Zoomable 15°-36°	>90	Zoomable 15°-36°	940lm	2700K	balck	white	MAGC16-W27ZO
			960lm	3000K	balck	white	MAGC16-W30ZO
			980lm	4000K	balck	white	MAGC16-W40ZO

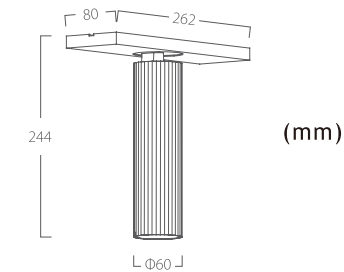

#### HOUSING IN DIFFERENT COLOR

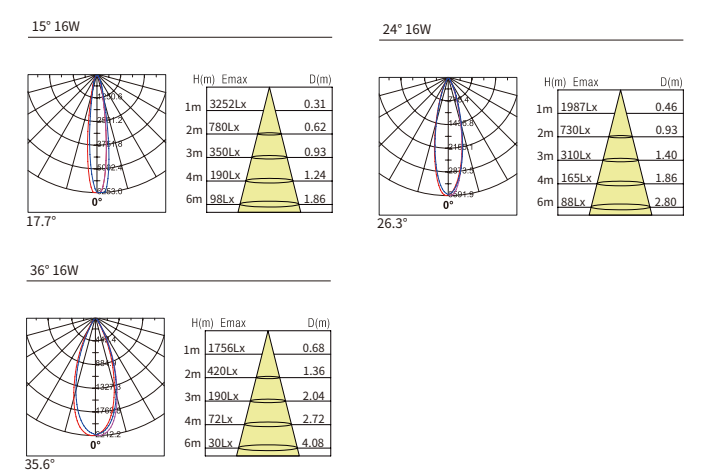

#### LED & Driver

CREE XPE  
Power: 19W/LED  
Voltage: 36V  
SDCM<5  
KEGU Driver:  
Input voltage:100-240VAC  
/220-240V/110-130V  
Output current:450mA  
Output voltage:DC36V





## Magic Ceiling

LED Type: LUMILEDS 5050 IP20 White as standard

Power	CRI	BeamAngle	Luminous Flux	CCT	Refractive screen	Frame	Model Number
2×10W	>90	15°	2x570lm	2700K	balck	white	MAGC210-W2715
			2x600lm	3000K	balck	white	MAGC210-W3015
			2x620lm	4000K	balck	white	MAGC210-W4015
		24°	2x570lm	2700K	balck	white	MAGC210-W2724
			2x600lm	3000K	balck	white	MAGC210-W3024
			2x620lm	4000K	balck	white	MAGC210-W4024
36°	2x570lm	2700K	balck	white	MAGC210-W2736		
	2x600lm	3000K	balck	white	MAGC210-W3036		
	2x620lm	4000K	balck	white	MAGC210-W4036		
Zoomable 15°-36°	>90	Zoomable 15°-36°	2x570lm	2700K	balck	white	MAGC210-W27Z0
			2x600lm	3000K	balck	white	MAGC210-W30Z0
			2x620lm	4000K	balck	white	MAGC210-W40Z0

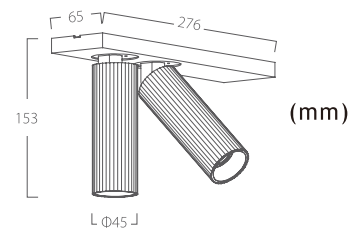

### HOUSING IN DIFFERENT COLOR

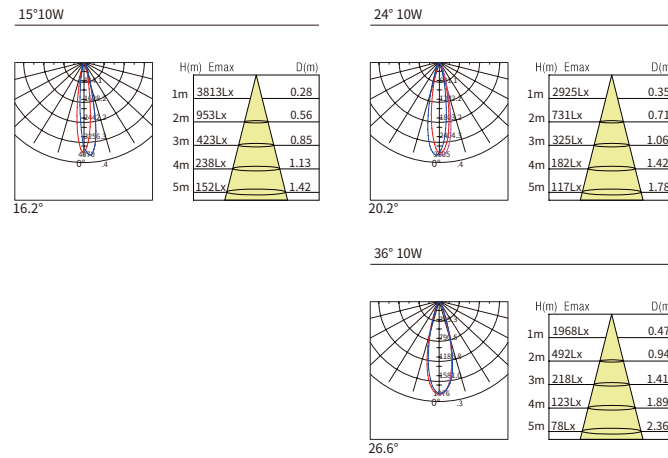

### LED & Driver

CREE XPE  
 Power: 2×12W/LED  
 Voltage: 24V  
 SDCM<5  
 KEGU Driver:  
 Input voltage:100-240VAC  
 /220-240V/110-130V  
 Output current:200mA  
 Output voltage:DC24V



## Magic Ceiling

LED Type: CREE COB IP20 White as standard

Power	CRI	BeamAngle	Luminous Flux	CCT	Refractive screen	Frame	Model Number
2×16W	>90	15°	2x940lm	2700K	balck	white	MAGC216-W2715
			2x960lm	3000K	balck	white	MAGC216-W3015
			2x980lm	4000K	balck	white	MAGC216-W4015
		24°	2x940lm	2700K	balck	white	MAGC216-W2724
			2x960lm	3000K	balck	white	MAGC216-W3024
			2x980lm	4000K	balck	white	MAGC216-W4024
36°	2x940lm	2700K	balck	white	MAGC216-W2736		
	2x960lm	3000K	balck	white	MAGC216-W3036		
	2x980lm	4000K	balck	white	MAGC216-W4036		
Zoomable 15°-36°	>90	Zoomable 15°-36°	2x940lm	2700K	balck	white	MAGC216-W27Z0
			2x960lm	3000K	balck	white	MAGC216-W30Z0
			2x980lm	4000K	balck	white	MAGC216-W40Z0

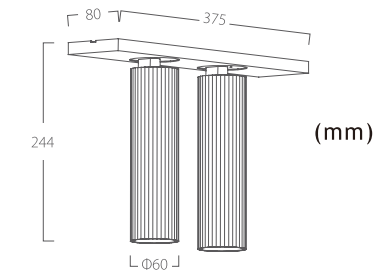

### HOUSING IN DIFFERENT COLOR

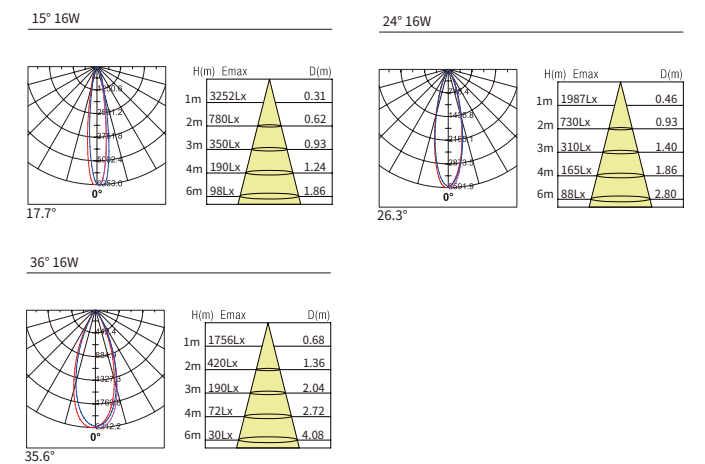

### LED & Driver

CREE XPE  
 Power: 2×18W/LED  
 Voltage: 36V  
 SDCM<5  
 MEANWELL Driver:  
 Input voltage:100-240VAC  
 /220-240V/110-130V  
 Output current:450mA  
 Output voltage:DC36V



LED Type: CREE XPE IP20 White as standard **Magic Surface**

Power	CRI	Beam Angle	Luminous Flux	CCT	Refractive screen	Frame	Model Number
5W	>90	15°	300lm	2700K	balck	white	MAGSUR05-W2715
			320lm	3000K	balck	white	MAGSUR05-W3015
			350lm	4000K	balck	white	MAGSUR05-W4015
		24°	300lm	2700K	balck	white	MAGSUR05-W2724
			320lm	3000K	balck	white	MAGSUR05-W3024
			350lm	4000K	balck	white	MAGSUR05-W4024
		36°	300lm	2700K	balck	white	MAGSUR05-W2736
			320lm	3000K	balck	white	MAGSUR05-W3036
			350lm	4000K	balck	white	MAGSUR05-W4036

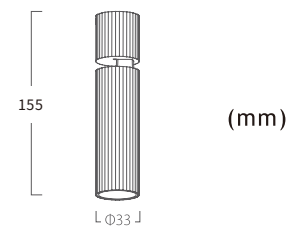

HOUSING IN DIFFERENT COLOR

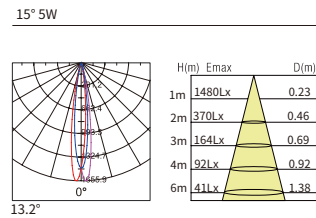

LED & Driver

CREE XPE  
 Power: 7W/LED  
 Voltage: 3V  
 SDCM<5  
 KEGU Driver:  
 Input voltage:100-240VAC  
 /220-240V/110-130V  
 Output current:700mA  
 Output voltage:DC3V



LED Type: CREE COB IP20 White as standard **Magic Surface**

Power	CRI	Beam Angle	Luminous Flux	CCT	Refractive screen	Frame	Model Number		
10W	>90	15°	570lm	2700K	balck	white	MAGSUR10-W2715		
			600lm	3000K	balck	white	MAGSUR10-W3015		
			620lm	4000K	balck	white	MAGSUR10-W4015		
		24°	570lm	2700K	balck	white	MAGSUR10-W2724		
			600lm	3000K	balck	white	MAGSUR10-W3024		
			620lm	4000K	balck	white	MAGSUR10-W4024		
		36°	570lm	2700K	balck	white	MAGSUR10-W2736		
			600lm	3000K	balck	white	MAGSUR10-W3036		
			620lm	4000K	balck	white	MAGSUR10-W4036		
		Zoomable 15°-36°			570lm	2700K	balck	white	MAGSUR10-W27Z0
					600lm	3000K	balck	white	MAGSUR10-W30Z0
					620lm	4000K	balck	white	MAGSUR10-W40Z0

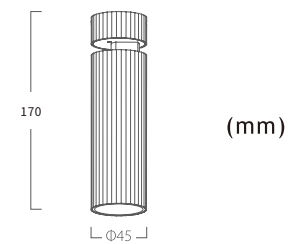

HOUSING IN DIFFERENT COLOR

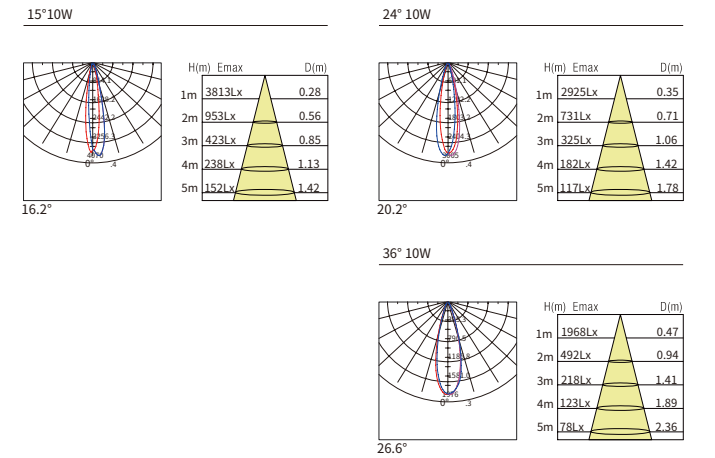

LED & Driver

CREE XPE  
 Power: 12W/LED  
 Voltage: 24V  
 SDCM<5  
 KEGU Driver:  
 Input voltage:100-240VAC  
 /220-240V/110-130V  
 Output current:200mA  
 Output voltage:DC24V



## Magic Surface

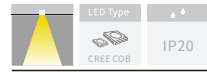

○ White as standard

Power	CRI	Beam Angle	Luminous Flux	CCT	Refractive screen	Frame	Model Number
16W	>90	15°	940lm	2700K	balck	white	MAGSUR16-W2715
			960lm	3000K	balck	white	MAGSUR16-W3015
			980lm	4000K	balck	white	MAGSUR16-W4015
		24°	940lm	2700K	balck	white	MAGSUR16-W2724
			960lm	3000K	balck	white	MAGSUR16-W3024
			980lm	4000K	balck	white	MAGSUR16-W4024
		36°	940lm	2700K	balck	white	MAGSUR16-W2736
			960lm	3000K	balck	white	MAGSUR16-W3036
			980lm	4000K	balck	white	MAGSUR16-W4036
Zoomable 15°-36°	940lm	2700K	balck	white	MAGSUR16-W27ZO		
	960lm	3000K	balck	white	MAGSUR16-W30ZO		
	980lm	4000K	balck	white	MAGSUR16-W40ZO		

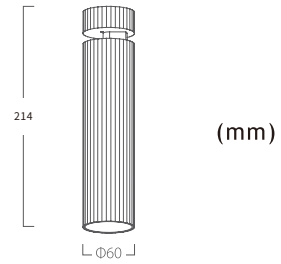

### HOUSING IN DIFFERENT COLOR

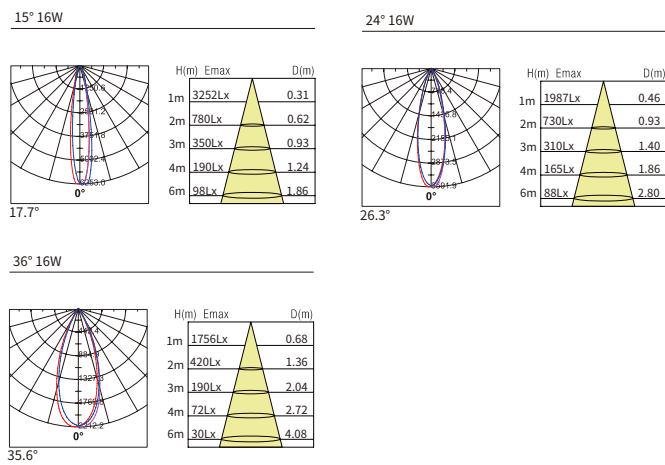

### LED & Driver

CREE XPE  
 Power: 18W/LED  
 Voltage: 36V  
 SDCM<5  
 MEANWELL Driver:  
 Input voltage:100-240VAC  
 /220-240V/110-130V  
 Output current:450mA  
 Output voltage:DC36V

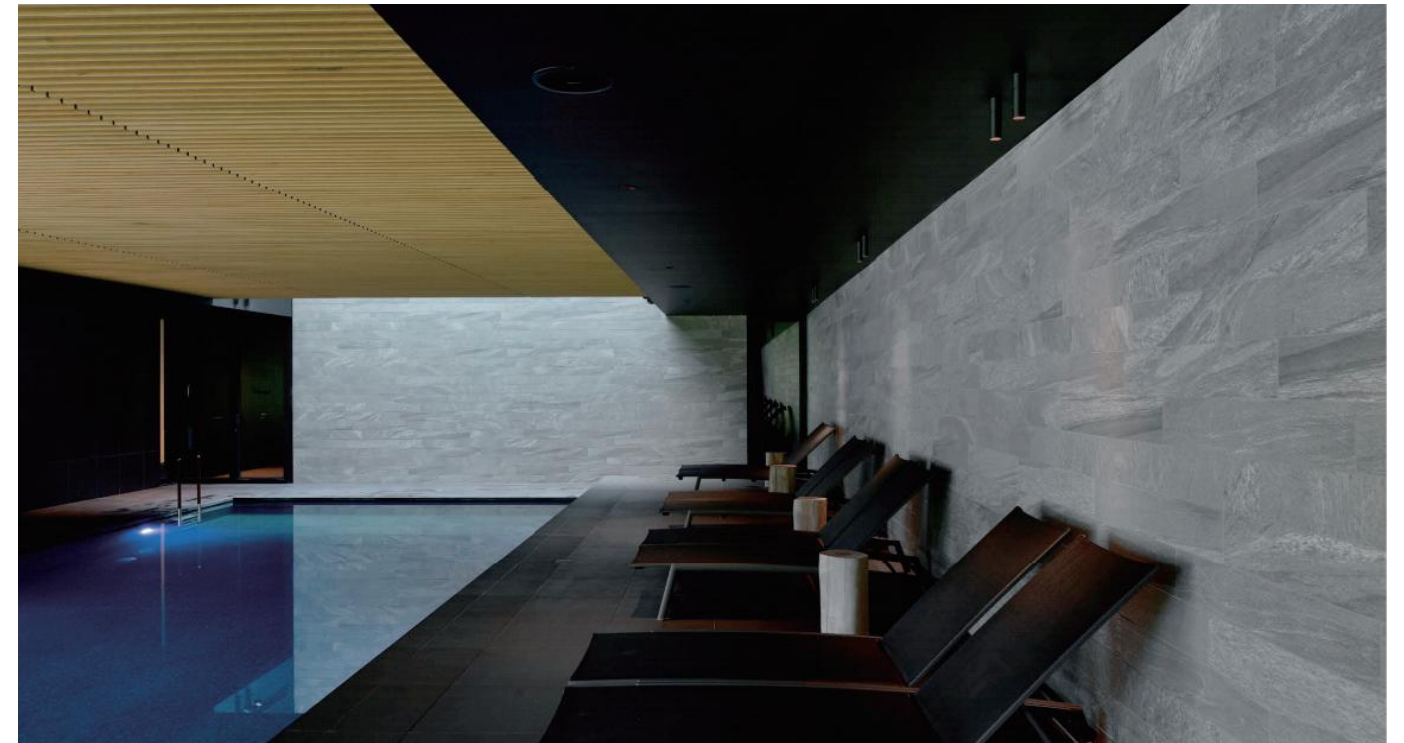



LED Type: CREE XPE  
IP20  
White as standard

### Magic Track

Power	CRI	Beam Angle	Luminous Flux	CCT	Refractive screen	Frame	Model Number
5W	>90	15°	300lm	2700K	balck	white	MAGT05-W2715
			320lm	3000K	balck	white	MAGT05-W3015
			350lm	4000K	balck	white	MAGT05-W4015
		24°	300lm	2700K	balck	white	MAGT05-W2724
			320lm	3000K	balck	white	MAGT05-W3024
			350lm	4000K	balck	white	MAGT05-W4024
		36°	300lm	2700K	balck	white	MAGT05-W2736
			320lm	3000K	balck	white	MAGT05-W3036
			350lm	4000K	balck	white	MAGT05-W4036

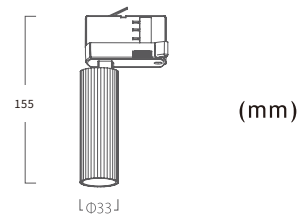

#### HOUSING IN DIFFERENT COLOR

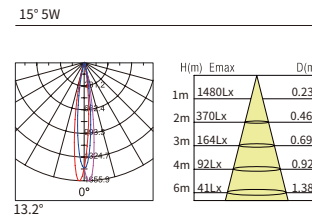

#### LED & Driver

CREE XPE  
Power: 7W/LED  
Voltage: 3V  
SDCM<5  
KEGU Driver:  
Input voltage:100-240VAC  
/220-240V/110-130V  
Output current:700mA  
Output voltage:DC3V



LED Type: LUMILEDS 9050  
IP20  
White as standard

### Magic Track

Power	CRI	Beam Angle	Luminous Flux	CCT	Refractive screen	Frame	Model Number
10W	>90	15°	570lm	2700K	balck	white	MAGT10-W2715
			600lm	3000K	balck	white	MAGT10-W3015
			620lm	4000K	balck	white	MAGT10-W4015
			570lm	2700K	balck	white	MAGT10-W2724
		24°	570lm	2700K	balck	white	MAGT10-W2724
			600lm	3000K	balck	white	MAGT10-W3024
			620lm	4000K	balck	white	MAGT10-W4024
			570lm	2700K	balck	white	MAGT10-W2736
		36°	570lm	2700K	balck	white	MAGT10-W2736
			600lm	3000K	balck	white	MAGT10-W3036
			620lm	4000K	balck	white	MAGT10-W4036
			Zoomable 15°-36°		570lm	2700K	balck
		600lm	3000K	balck	white	MAGT10-W30ZO	
		620lm	4000K	balck	white	MAGT10-W40ZO	

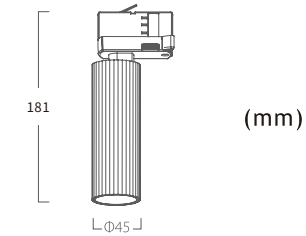

#### HOUSING IN DIFFERENT COLOR

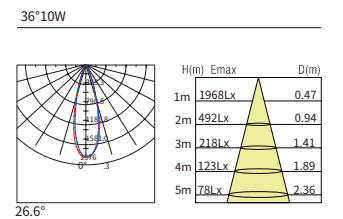
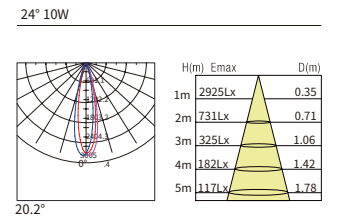
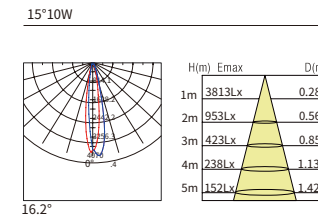

#### LED & Driver

CREE XPE  
Power: 12W/LED  
Voltage: 24V  
SDCM<5  
KEGU Driver:  
Input voltage:100-240VAC  
/220-240V/110-130V  
Output current:200mA  
Output voltage:DC24V



## Magic Track



White as standard

Power	CRI	Beam Angle	Luminous Flux	CCT	Refractive screen	Frame	Model Number
16W	>90	15°	940lm	2700K	balck	white	MAGT16-W2715
			960lm	3000K	balck	white	MAGT16-W3015
			980lm	4000K	balck	white	MAGT16-W4015
		24°	940lm	2700K	balck	white	MAGT16-W2724
			960lm	3000K	balck	white	MAGT16-W3024
			980lm	4000K	balck	white	MAGT16-W4024
36°	940lm	2700K	balck	white	MAGT16-W2736		
	960lm	3000K	balck	white	MAGT16-W3036		
	980lm	4000K	balck	white	MAGT16-W4036		
Zoomable 15°-36°	>90	Zoomable 15°-36°	940lm	2700K	balck	white	MAGT16-W27ZO
			960lm	3000K	balck	white	MAGT16-W30ZO
			980lm	4000K	balck	white	MAGT16-W40ZO

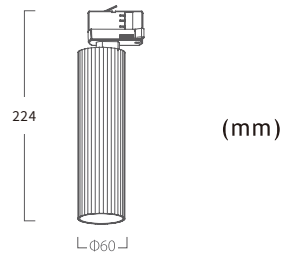

### HOUSING IN DIFFERENT COLOR

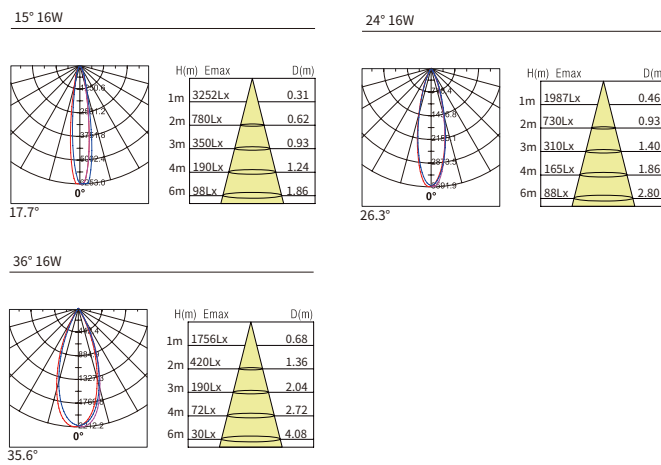

### LED & Driver

CREE XPE  
 Power: 18W/LED  
 Voltage: 36V  
 SDCM<5  
 MEANWELL Driver:  
 Input voltage:100-240VAC  
 /220-240V/110-130V  
 Output current:450mA  
 Output voltage:DC36V



LED Type: CREE XPE  
IP20  
White as standard

### Magic Recessed

Power	CRI	Beam Angle	Luminous Flux	CCT	Refractive screen	Frame	Model Number
5W	>90	15°	300lm	2700K	balck	white	MAGR05-W2715
			320lm	3000K	balck	white	MAGR05-W3015
			350lm	4000K	balck	white	MAGR05-W4015
		24°	300lm	2700K	balck	white	MAGR05-W2724
			320lm	3000K	balck	white	MAGR05-W3024
			350lm	4000K	balck	white	MAGR05-W4024
		36°	300lm	2700K	balck	white	MAGR05-W2736
			320lm	3000K	balck	white	MAGR05-W3036
			350lm	4000K	balck	white	MAGR05-W4036

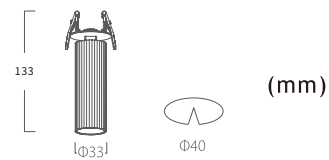

#### HOUSING IN DIFFERENT COLOR

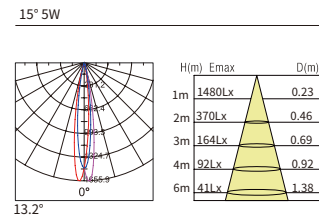

#### LED & Driver

CREE XPE  
Power: 7W/LED  
Voltage: 3V  
SDCM<5  
KEGU Driver:  
Input voltage: 100-240VAC  
/220-240V/110-130V  
Output current: 700mA  
Output voltage: DC3V



LED Type: LUMILEDS 9050  
IP20  
White as standard

### Magic Recessed

Power	CRI	Beam Angle	Luminous Flux	CCT	Refractive screen	Frame	Model Number		
10W	>90	15°	570lm	2700K	balck	white	MAGR10-W2715		
			600lm	3000K	balck	white	MAGR10-W3015		
			620lm	4000K	balck	white	MAGR10-W4015		
			570lm	2700K	balck	white	MAGR10-W2724		
			600lm	3000K	balck	white	MAGR10-W3024		
		24°	570lm	2700K	balck	white	MAGR10-W2724		
			600lm	3000K	balck	white	MAGR10-W3024		
			620lm	4000K	balck	white	MAGR10-W4024		
			570lm	2700K	balck	white	MAGR10-W2736		
			600lm	3000K	balck	white	MAGR10-W3036		
		36°	570lm	2700K	balck	white	MAGR10-W2736		
			600lm	3000K	balck	white	MAGR10-W3036		
			620lm	4000K	balck	white	MAGR10-W4036		
			Zoomable 15°-36°		570lm	2700K	balck	white	MAGR10-W27ZO
			Zoomable 15°-36°		600lm	3000K	balck	white	MAGR10-W30ZO
Zoomable 15°-36°		620lm	4000K	balck	white	MAGR10-W40ZO			

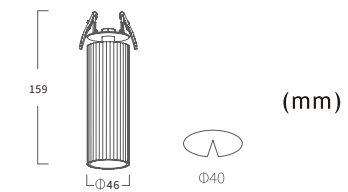

#### HOUSING IN DIFFERENT COLOR

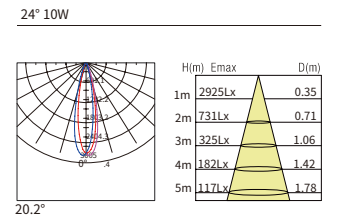
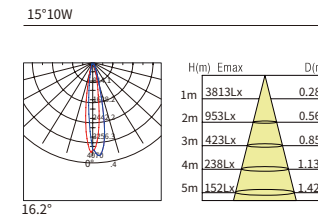

#### LED & Driver

CREE XPE  
Power: 12W/LED  
Voltage: 24V  
SDCM<5  
KEGU Driver:  
Input voltage: 100-240VAC  
/220-240V/110-130V  
Output current: 200mA  
Output voltage: DC24V

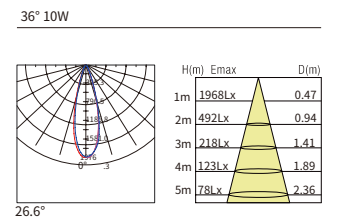



LED Type: CREE XPE  
IP20  
White as standard

### Magic Inout

Power	CRI	Beam Angle	Luminous Flux	CCT	Refractive screen	Frame	Model Number
5W	>90	15°	300lm	2700K	balck	white	MAGI05-W2715
			320lm	3000K	balck	white	MAGI05-W3015
			350lm	4000K	balck	white	MAGI05-W4015
		24°	300lm	2700K	balck	white	MAGI05-W2724
			320lm	3000K	balck	white	MAGI05-W3024
			350lm	4000K	balck	white	MAGI05-W4024
		36°	300lm	2700K	balck	white	MAGI05-W2736
			320lm	3000K	balck	white	MAGI05-W3036
			350lm	4000K	balck	white	MAGI05-W4036

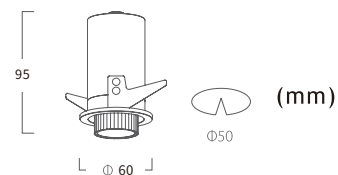

#### HOUSING IN DIFFERENT COLOR

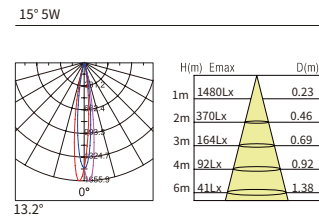

#### LED & Driver

CREE XPE  
Power: 7W/LED  
Voltage: 3V  
SDCM<5  
KEGU Driver:  
Input voltage:100-240VAC  
/220-240V/110-130V  
Output current:700mA  
Output voltage:DC3V



LED Type: LMHILEDS 9050  
IP20  
White as standard

### Magic Inout

Power	CRI	Beam Angle	Luminous Flux	CCT	Refractive screen	Frame	Model Number
7W	>90	15°	400lm	2700K	balck	white	MAGI07-W2715
			420lm	3000K	balck	white	MAGI07-W3015
			450lm	4000K	balck	white	MAGI07-W4015
		24°	400lm	2700K	balck	white	MAGI07-W2724
			420lm	3000K	balck	white	MAGI07-W3024
			450lm	4000K	balck	white	MAGI07-W4024
		36°	400lm	2700K	balck	white	MAGI07-W2736
			420lm	3000K	balck	white	MAGI07-W3036
			450lm	4000K	balck	white	MAGI07-W4036
		Zoomable 15°-36°	400lm	2700K	balck	white	MAGI07-W27ZO
			420lm	3000K	balck	white	MAGI07-W30ZO
			450lm	4000K	balck	white	MAGI07-W40ZO

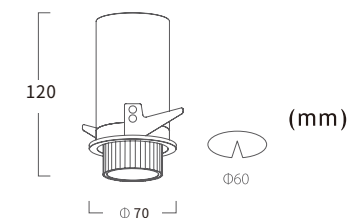

#### HOUSING IN DIFFERENT COLOR

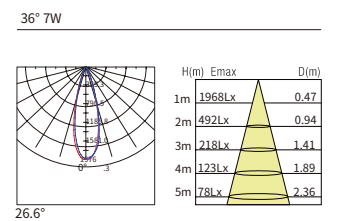
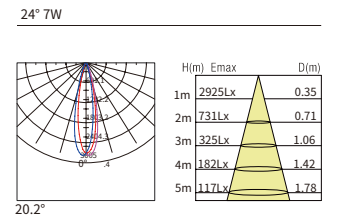
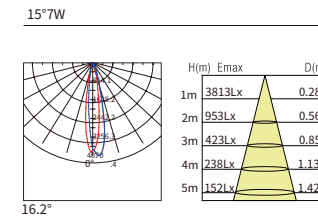

#### LED & Driver

CREE XPE  
Power: 9W/LED  
Voltage: 24V  
SDCM<5  
KEGU Driver:  
Input voltage:100-240VAC  
/220-240V/110-130V  
Output current:200mA  
Output voltage:DC24V



## Magic Inout



White as standard

Power	CRI	Beam Angle	Luminous Flux	CCT	Refractive screen	Frame	Model Number
15W	>90	15°	900lm	2700K	balck	white	MAGI15-W2715
			920lm	3000K	balck	white	MAGI15-W3015
			950lm	4000K	balck	white	MAGI15-W4015
		24°	900lm	2700K	balck	white	MAGI15-W2724
			920lm	3000K	balck	white	MAGI15-W3024
			950lm	4000K	balck	white	MAGI15-W4024
		36°	900lm	2700K	balck	white	MAGI15-W2736
			920lm	3000K	balck	white	MAGI15-W3036
			950lm	4000K	balck	white	MAGI15-W4036
Zoomable 15°-36°	>90	Zoomable 15°-36°	900lm	2700K	balck	white	MAGI15-W27ZO
			920lm	3000K	balck	white	MAGI15-W30ZO
			950lm	4000K	balck	white	MAGI15-W40ZO

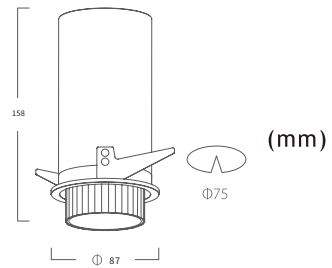

### HOUSING IN DIFFERENT COLOR



15° 15W

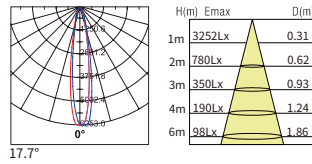

24° 15W

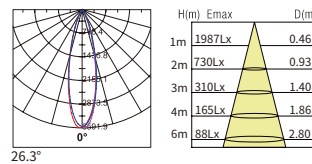

36° 15W

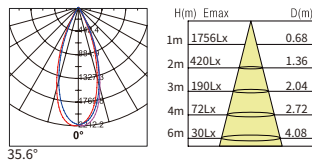

### LED & Driver

CREE XPE  
 Power: 17W/LED  
 Voltage: 36V  
 SDCM<6  
 MEANWELL Driver:  
 Input voltage:100-240VAC  
 /220-240V/110-130V  
 Output current:450mA  
 Output voltage:DC36V



LED Type: CREE XPE  
IP20  
White as standard

### Magic Single

Power	CRI	Beam Angle	Luminous Flux	CCT	Refractive screen	Frame	Model Number
5W	>90	15°	300lm	2700K	balck	white	MAGS05-W2715
			320lm	3000K	balck	white	MAGS05-W3015
			350lm	4000K	balck	white	MAGS05-W4015
		24°	300lm	2700K	balck	white	MAGS05-W2724
			320lm	3000K	balck	white	MAGS05-W3024
			350lm	4000K	balck	white	MAGS05-W4024
		36°	300lm	2700K	balck	white	MAGS05-W2736
			320lm	3000K	balck	white	MAGS05-W3036
			350lm	4000K	balck	white	MAGS05-W4036

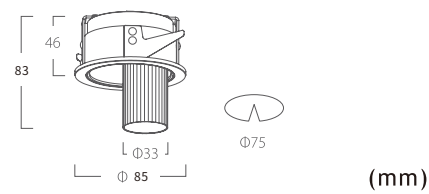

#### HOUSING IN DIFFERENT COLOR

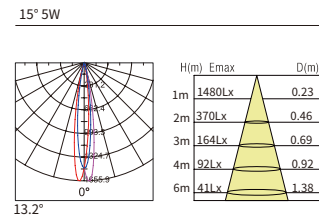

#### LED & Driver

CREE XPE  
Power: 7W/LED  
Voltage: 3V  
SDCM<6  
KEGU Driver:  
Input voltage:100-240VAC  
/220-240V/110-130V  
Output current:700mA  
Output voltage:DC3V



LED Type: LMHILEDS 9050  
IP20  
White as standard

### Magic Single

Power	CRI	Beam Angle	Luminous Flux	CCT	Refractive screen	Frame	Model Number
7W	>90	15°	400lm	2700K	balck	white	MAGS07-W2715
			420lm	3000K	balck	white	MAGS07-W3015
			450lm	4000K	balck	white	MAGS07-W4015
		24°	400lm	2700K	balck	white	MAGS07-W2724
			420lm	3000K	balck	white	MAGS07-W3024
			450lm	4000K	balck	white	MAGS07-W4024
		36°	400lm	2700K	balck	white	MAGS07-W2736
			420lm	3000K	balck	white	MAGS07-W3036
			450lm	4000K	balck	white	MAGS07-W4036
		Zoomable 15°-36°	400lm	2700K	balck	white	MAGS07-W27ZO
			420lm	3000K	balck	white	MAGS07-W30ZO
			450lm	4000K	balck	white	MAGS07-W40ZO

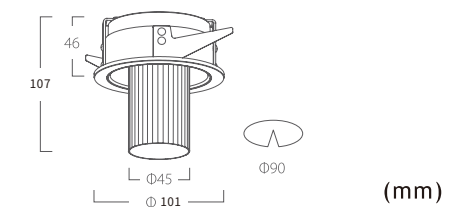

#### HOUSING IN DIFFERENT COLOR

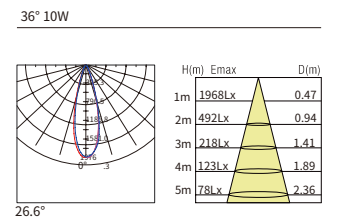
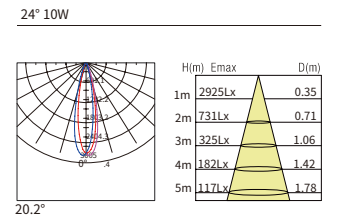
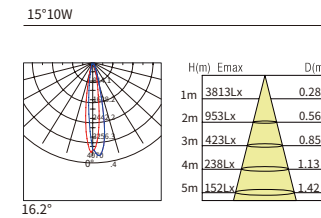

#### LED & Driver

CREE XPE  
Power: 12W/LED  
Voltage: 24V  
SDCM<6  
KEGU Driver:  
Input voltage:100-240VAC  
/220-240V/110-130V  
Output current:200mA  
Output voltage:DC24V





LED Type: CREE COB IP20 White as standard

### Magic Single

Power	CRI	Beam Angle	Luminous Flux	CCT	Refractive screen	Frame	Model Number
15W	>90	15°	900lm	2700K	balck	white	MAGS15-W2715
			920lm	3000K	balck	white	MAGS15-W3015
			950lm	4000K	balck	white	MAGS15-W4015
		24°	900lm	2700K	balck	white	MAGS15-W2724
			920lm	3000K	balck	white	MAGS15-W3024
			950lm	4000K	balck	white	MAGS15-W4024
		36°	900lm	2700K	balck	white	MAGS15-W2736
			920lm	3000K	balck	white	MAGS15-W3036
			950lm	4000K	balck	white	MAGS15-W4036
Zoomable 15°-36°	>90	Zoomable 15°-36°	900lm	2700K	balck	white	MAGS15-W27ZO
			920lm	3000K	balck	white	MAGS15-W30ZO
			950lm	4000K	balck	white	MAGS15-W40ZO

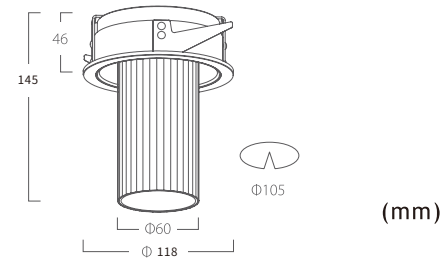

#### HOUSING IN DIFFERENT COLOR

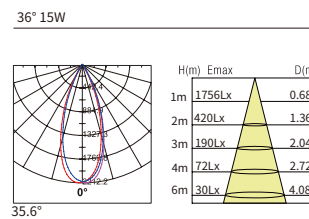
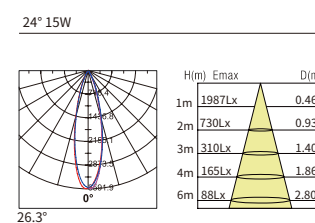
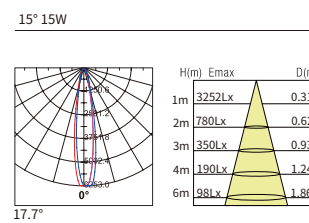

#### LED & Driver

CREE XPE  
 Power: 17W/LED  
 Voltage: 36V  
 SDCM<5  
 MEANWELL Driver:  
 Input voltage:100-240VAC  
 /220-240V/110-130V  
 Output current:450mA  
 Output voltage:DC36V



LED Type: CREE XPE IP20 White as standard

### Magic Double

Power	CRI	Beam Angle	Luminous Flux	CCT	Refractive screen	Frame	Model Number
2×5W	>90	15°	2x300lm	2700K	balck	white	MAGD205-W2715
			2x320lm	3000K	balck	white	MAGD205-W3015
			2x350lm	4000K	balck	white	MAGD205-W4015
		24°	2x300lm	2700K	balck	white	MAGD205-W2724
			2x320lm	3000K	balck	white	MAGD205-W3024
			2x350lm	4000K	balck	white	MAGD205-W4024
		36°	2x300lm	2700K	balck	white	MAGD205-W2736
			2x320lm	3000K	balck	white	MAGD205-W3036
			2x350lm	4000K	balck	white	MAGD205-W4036

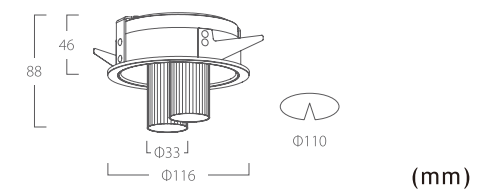
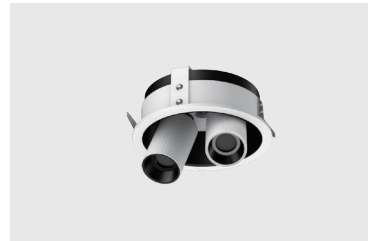

#### HOUSING IN DIFFERENT COLOR

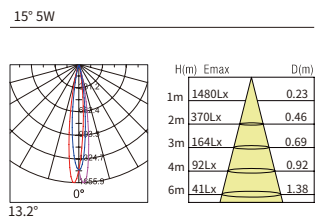

#### LED & Driver

CREE XPE  
 Power: 2\*7W/LED  
 Voltage: 3V  
 SDCM<5  
 KEGU Driver:  
 Input voltage:100-240VAC  
 /220-240V/110-130V  
 Output current:700mA  
 Output voltage:DC3V



LED Type: LUMILEDS 5050  
IP20  
White as standard

### Magic Double

Power	CRI	BeamAngle	Luminous Flux	CCT	Refractive screen	Frame	Model Number
2×7W	>90	15°	2x400lm	2700K	balck	white	MAGD207-W2715
			2x420lm	3000K	balck	white	MAGD207-W3015
			2x450lm	4000K	balck	white	MAGD207-W4015
		24°	2x400lm	2700K	balck	white	MAGD207-W2724
			2x420lm	3000K	balck	white	MAGD207-W3024
			2x450lm	4000K	balck	white	MAGD207-W4024
		36°	2x400lm	2700K	balck	white	MAGD207-W2736
			2x420lm	3000K	balck	white	MAGD207-W3036
			2x450lm	4000K	balck	white	MAGD207-W4036
Zoomable 15°-36°			2x400lm	2700K	balck	white	MAGD207-W27ZO
			2x420lm	3000K	balck	white	MAGD207-W30ZO
			2x450lm	4000K	balck	white	MAGD207-W40ZO

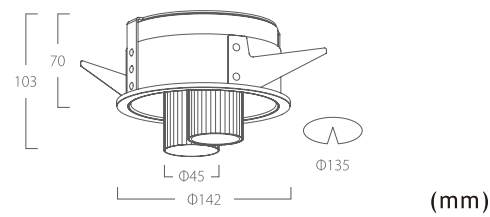

#### HOUSING IN DIFFERENT COLOR

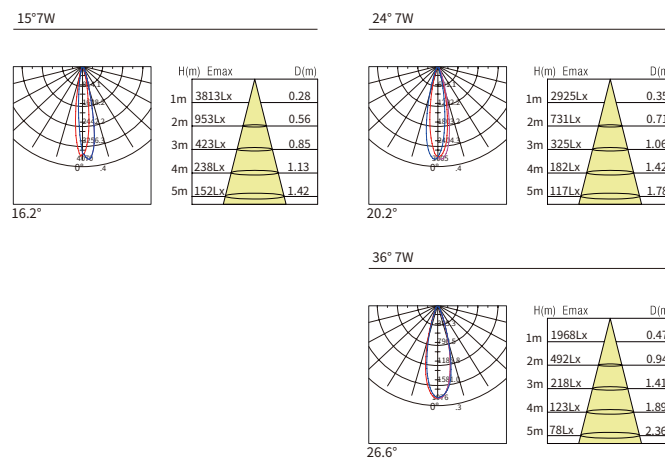

#### LED & Driver

CREE XPE  
Power: 2\*9W/LED  
Voltage: 24V  
SDCM<5  
KEGU Driver:  
Input voltage:100-240VAC  
/220-240V/110-130V  
Output current:200mA  
Output voltage:DC24V



LED Type: CREE COB  
IP20  
White as standard

### Magic Double

Power	CRI	BeamAngle	Luminous Flux	CCT	Refractive screen	Frame	Model Number
2×15W	>90	15°	2x900lm	2700K	balck	white	MAGD215-W2715
			2x920lm	3000K	balck	white	MAGD215-W3015
			2x950lm	4000K	balck	white	MAGD215-W4015
		24°	2x900lm	2700K	balck	white	MAGD215-W2724
			2x920lm	3000K	balck	white	MAGD215-W3024
			2x950lm	4000K	balck	white	MAGD215-W4024
		36°	2x900lm	2700K	balck	white	MAGD215-W2736
			2x920lm	3000K	balck	white	MAGD215-W3036
			2x950lm	4000K	balck	white	MAGD215-W4036
Zoomable 15°-36°			2x900lm	2700K	balck	white	MAGD215-W27ZO
			2x920lm	3000K	balck	white	MAGD215-W30ZO
			2x950lm	4000K	balck	white	MAGD215-W40ZO

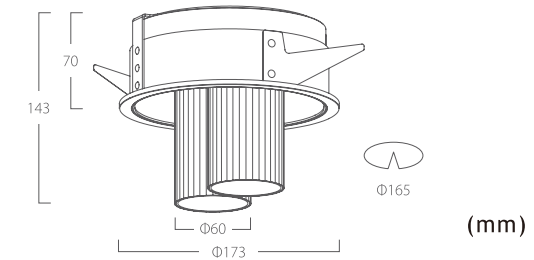

#### HOUSING IN DIFFERENT COLOR

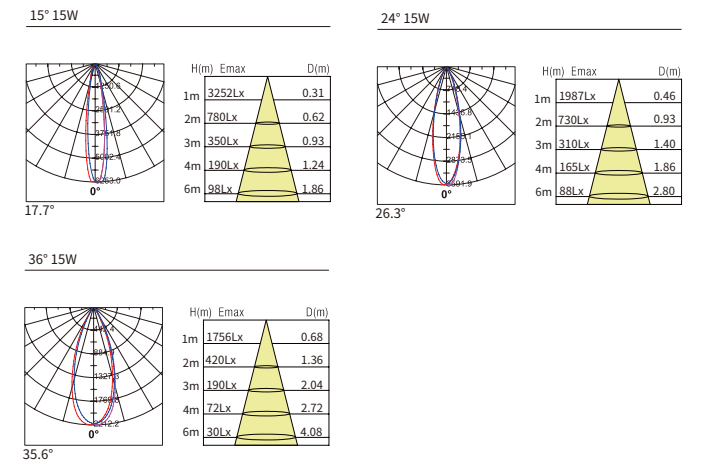

#### LED & Driver

CREE XPE  
Power: 2\*17W/LED  
Voltage: 36V  
SDCM<5  
MEANWELL Driver:  
Input voltage:100-240VAC  
/220-240V/110-130V  
Output current:450mA  
Output voltage:DC36V



LED Type: CREE XPE  
IP20  
White as standard

### Magic Trimless

Power	CRI	Beam Angle	Luminous Flux	CCT	Refractive screen	Frame	Model Number
5W	>90	15°	300lm	2700K	balck	white	MAGTR05-W2715
			320lm	3000K	balck	white	MAGTR05-W3015
			350lm	4000K	balck	white	MAGTR05-W4015
		24°	300lm	2700K	balck	white	MAGTR05-W2724
			320lm	3000K	balck	white	MAGTR05-W3024
			350lm	4000K	balck	white	MAGTR05-W4024
		36°	300lm	2700K	balck	white	MAGTR05-W2736
			320lm	3000K	balck	white	MAGTR05-W3036
			350lm	4000K	balck	white	MAGTR05-W4036

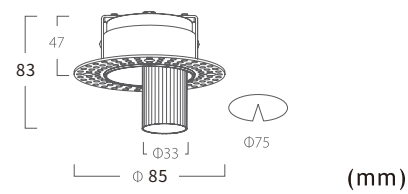

#### HOUSING IN DIFFERENT COLOR

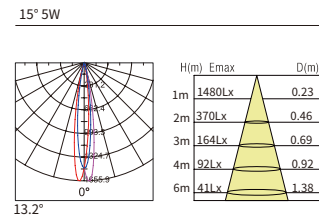

#### LED & Driver

CREE XPE  
Power: 7W/LED  
Voltage: 3V  
SDCM<5  
KEGU Driver:  
Input voltage:100-240VAC  
/220-240V/110-130V  
Output current:700mA  
Output voltage:DC3V



LED Type: LUMILEDS 9050  
IP20  
White as standard

### Magic Trimless

Power	CRI	Beam Angle	Luminous Flux	CCT	Refractive screen	Frame	Model Number		
7W	>90	15°	400lm	2700K	balck	white	MAGTR07-W2715		
			420lm	3000K	balck	white	MAGTR07-W3015		
			450lm	4000K	balck	white	MAGTR07-W4015		
			400lm	2700K	balck	white	MAGTR07-W2724		
			420lm	3000K	balck	white	MAGTR07-W3024		
		24°	400lm	2700K	balck	white	MAGTR07-W2724		
			420lm	3000K	balck	white	MAGTR07-W3024		
			450lm	4000K	balck	white	MAGTR07-W4024		
			400lm	2700K	balck	white	MAGTR07-W2736		
			420lm	3000K	balck	white	MAGTR07-W3036		
		36°	400lm	2700K	balck	white	MAGTR07-W2736		
			420lm	3000K	balck	white	MAGTR07-W3036		
			450lm	4000K	balck	white	MAGTR07-W4036		
			Zoomable 15°-36°		400lm	2700K	balck	white	MAGTR07-W27ZO
			Zoomable 15°-36°		420lm	3000K	balck	white	MAGTR07-W30ZO
Zoomable 15°-36°		450lm	4000K	balck	white	MAGTR07-W40ZO			

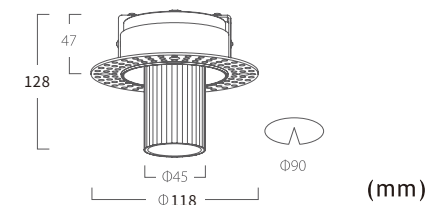

#### HOUSING IN DIFFERENT COLOR

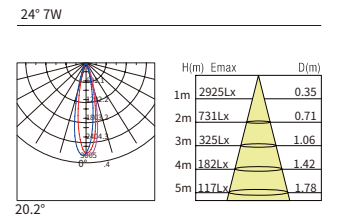
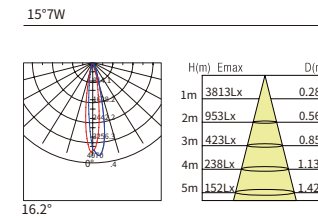

#### LED & Driver

CREE XPE  
Power: 9W/LED  
Voltage: 24V  
SDCM<5  
KEGU Driver:  
Input voltage:100-240VAC  
/220-240V/110-130V  
Output current:200mA  
Output voltage:DC24V





LED Type: CREE COB IP20 White as standard

### Magic Trimless

Power	CRI	Beam Angle	Luminous Flux	CCT	Refractive screen	Frame	Model Number
15W	>90	15°	900lm	2700K	balck	white	MAGTR15-W2715
			920lm	3000K	balck	white	MAGTR15-W3015
			950lm	4000K	balck	white	MAGTR15-W4015
		24°	900lm	2700K	balck	white	MAGTR15-W2724
			920lm	3000K	balck	white	MAGTR15-W3024
			950lm	4000K	balck	white	MAGTR15-W4024
		36°	900lm	2700K	balck	white	MAGTR15-W2736
			920lm	3000K	balck	white	MAGTR15-W3036
			950lm	4000K	balck	white	MAGTR15-W4036
Zoomable 15°-36°	>90	Zoomable 15°-36°	900lm	2700K	balck	white	MAGTR15-W27ZO
			920lm	3000K	balck	white	MAGTR15-W30ZO
			950lm	4000K	balck	white	MAGTR15-W40ZO

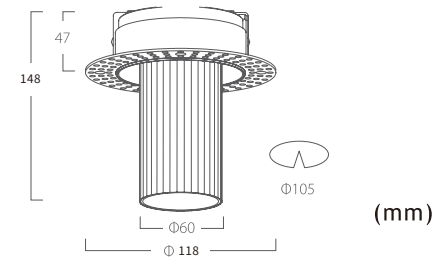

#### HOUSING IN DIFFERENT COLOR

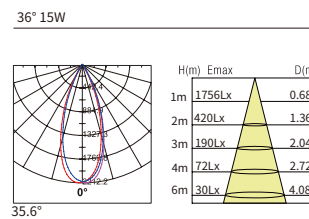
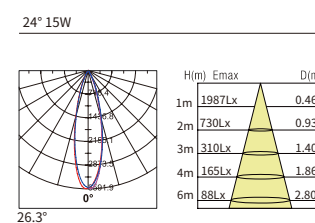
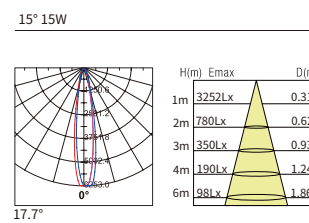

#### LED & Driver

CREE XPE  
 Power: 17W/LED  
 Voltage: 36V  
 SDCM<5  
 MEANWELL Driver:  
 Input voltage:100-240VAC  
 /220-240V/110-130V  
 Output current:450mA  
 Output voltage:DC36V



LED Type: CREE XPE IP20 White as standard

### Magic Trimless

Power	CRI	Beam Angle	Luminous Flux	CCT	Refractive screen	Frame	Model Number
2×5W	>90	15°	2x300lm	2700K	balck	white	MAGTR205-W2715
			2x320lm	3000K	balck	white	MAGTR205-W3015
			2x350lm	4000K	balck	white	MAGTR205-W4015
			2x300lm	2700K	balck	white	MAGTR205-W2724
		24°	2x320lm	3000K	balck	white	MAGTR205-W3024
			2x350lm	4000K	balck	white	MAGTR205-W4024
			2x300lm	2700K	balck	white	MAGTR205-W2736
			2x320lm	3000K	balck	white	MAGTR205-W3036
		36°	2x350lm	4000K	balck	white	MAGTR205-W4036

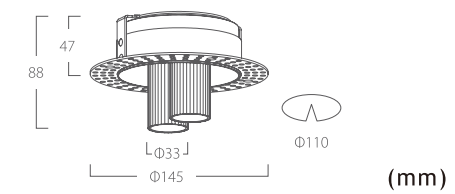

#### HOUSING IN DIFFERENT COLOR

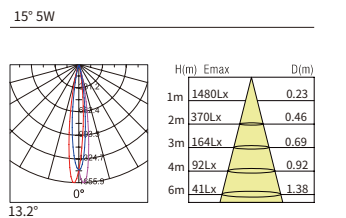

#### LED & Driver

CREE XPE  
 Power: 2\*7W/LED  
 Voltage: 3V  
 SDCM<5  
 KEGU Driver:  
 Input voltage:100-240VAC  
 /220-240V/110-130V  
 Output current:700mA  
 Output voltage:DC3V



LED Type: LUMILEDS 5050 IP20 White as standard

### Magic Trimless

Power	CRI	BeamAngle	Luminous Flux	CCT	Refractive screen	Frame	Model Number
2x7W	>90	15°	2x400lm	2700K	balck	white	MAGTR207-W2715
			2x420lm	3000K	balck	white	MAGTR207-W3015
			2x450lm	4000K	balck	white	MAGTR207-W4015
		24°	2x400lm	2700K	balck	white	MAGTR207-W2724
			2x420lm	3000K	balck	white	MAGTR207-W3024
			2x450lm	4000K	balck	white	MAGTR207-W4024
		36°	2x400lm	2700K	balck	white	MAGTR207-W2736
			2x420lm	3000K	balck	white	MAGTR207-W3036
			2x450lm	4000K	balck	white	MAGTR207-W4036
Zoomable 15°-36°			2x400lm	2700K	balck	white	MAGTR207-W27Z0
			2x420lm	3000K	balck	white	MAGTR207-W30Z0
			2x450lm	4000K	balck	white	MAGTR207-W40Z0

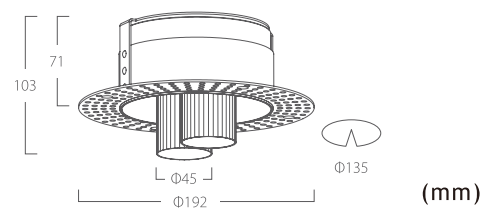

#### HOUSING IN DIFFERENT COLOR

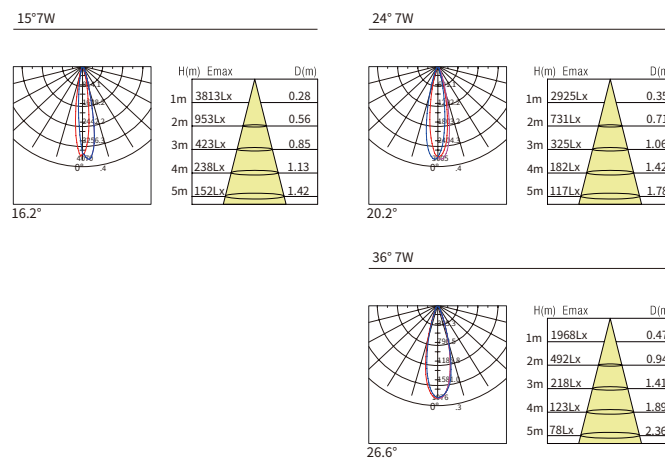

#### LED & Driver

CREE XPE  
 Power: 2\*9W/LED  
 Voltage: 24V  
 SDCM<5  
 KEGU Driver:  
 Input voltage:100-240VAC  
 /220-240V/110-130V  
 Output current:200mA  
 Output voltage:DC24V



LED Type: CREE COB IP20 White as standard

### Magic Trimless

Power	CRI	BeamAngle	Luminous Flux	CCT	Refractive screen	Frame	Model Number
2x15W	>90	15°	2x900lm	2700K	balck	white	MAGTR215-W2715
			2x920lm	3000K	balck	white	MAGTR215-W3015
			2x950lm	4000K	balck	white	MAGTR215-W4015
		24°	2x900lm	2700K	balck	white	MAGTR215-W2724
			2x920lm	3000K	balck	white	MAGTR215-W3024
			2x950lm	4000K	balck	white	MAGTR215-W4024
		36°	2x900lm	2700K	balck	white	MAGTR215-W2736
			2x920lm	3000K	balck	white	MAGTR215-W3036
			2x950lm	4000K	balck	white	MAGTR215-W4036
Zoomable 15°-36°			2x900lm	2700K	balck	white	MAGTR215-W27Z0
			2x920lm	3000K	balck	white	MAGTR215-W30Z0
			2x950lm	4000K	balck	white	MAGTR215-W40Z0

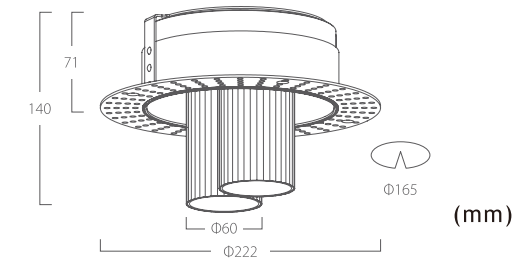

#### HOUSING IN DIFFERENT COLOR

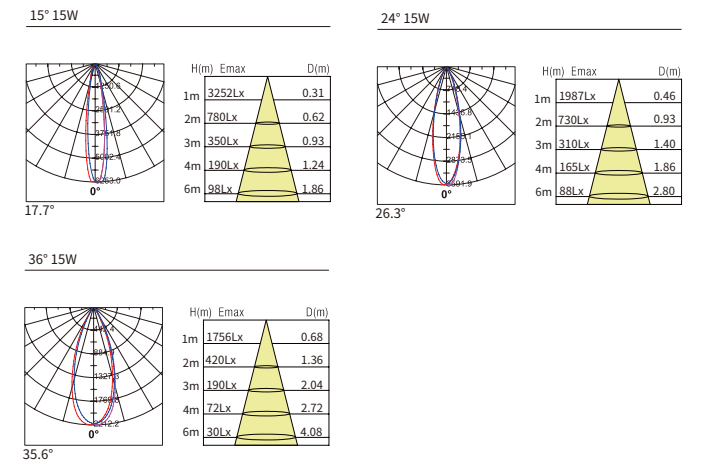

#### LED & Driver

CREE XPE  
 Power: 2\*17W/LED  
 Voltage: 36V  
 SDCM<5  
 MEANWELL Driver:  
 Input voltage:100-240VAC  
 /220-240V/110-130V  
 Output current:450mA  
 Output voltage:DC36V



# Bath

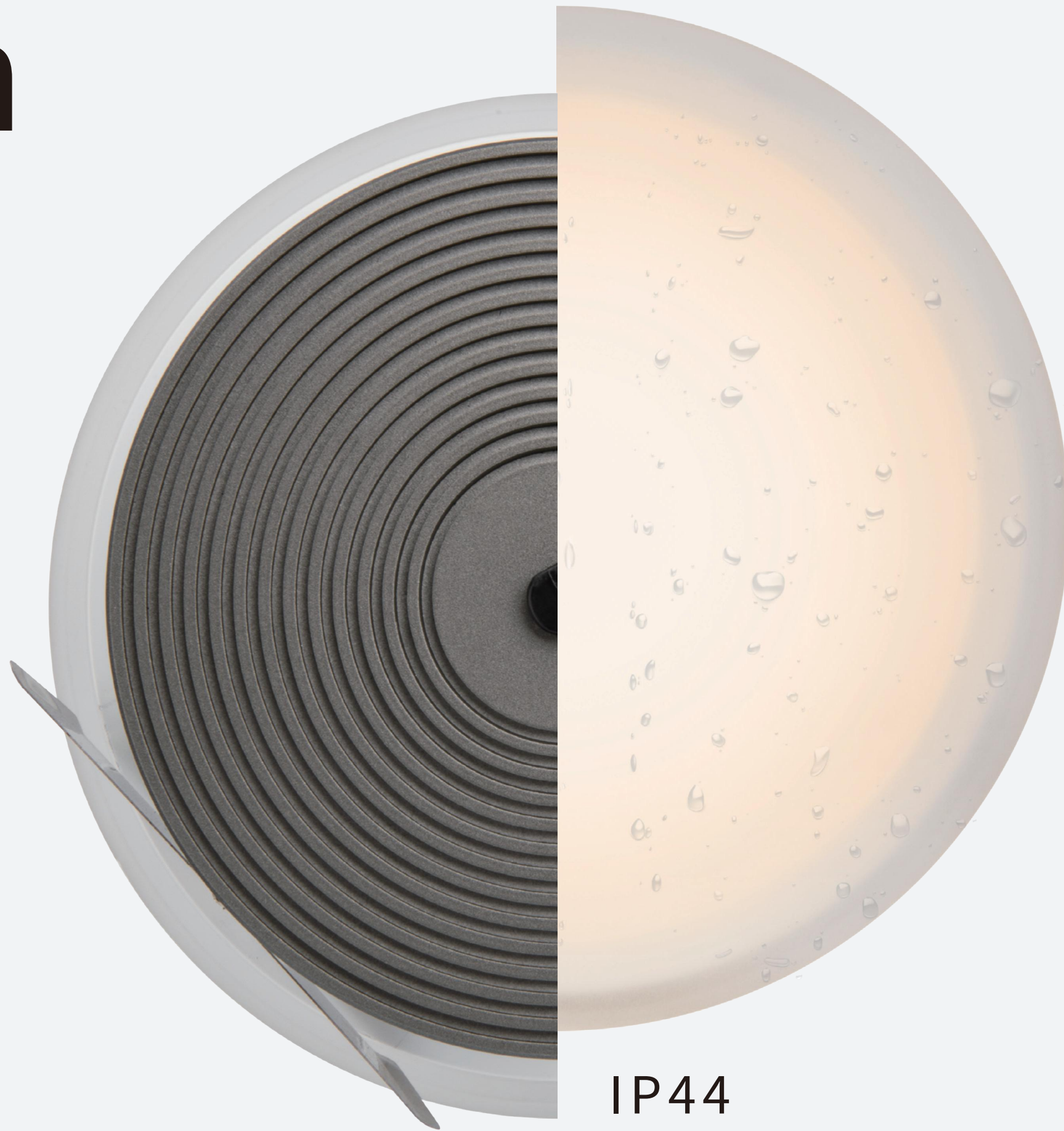

IP44



LED Type: SMD 2835 IP44 White as standard Bath

Power	CRI	BeamAngle	Luminous Flux	CCT	Refractive screen	Frame	Model Number
3W	>80	120°	120lm	2700K	acrylic	white	BATH03-W27
			150lm	3000K	acrylic	white	BATH03-W30
			180lm	4000K	acrylic	white	BATH03-W40
			200lm	6000K	acrylic	white	BATH03-W60
6W	>80	120°	385lm	2700K	acrylic	white	BATH06-W27
			400lm	3000K	acrylic	white	BATH03-W30
			420lm	4000K	acrylic	white	BATH03-W40
			500lm	6000K	acrylic	white	BATH03-W60



(mm)

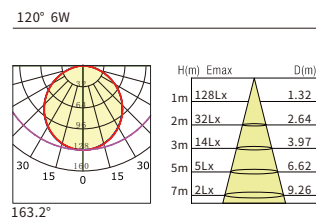
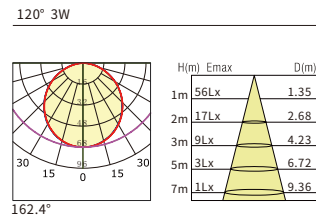

LED & Driver

SMD 2835:  
 Power: 0.2W/LED  
 Voltage: 3V-3.1V  
 SDCM<5  
 Philips Driver:  
 Input voltage: 100-240VAC  
 /220-240V/110-130V  
 Output:  
 3W-250mA 9V  
 6W-150mA 36-40V



LED Type: SMD 2835 IP44 White as standard Bath

Power	CRI	BeamAngle	Luminous Flux	CCT	Refractive screen	Frame	Model Number
12W	>80	120°	860lm	2700K	acrylic	white	BATH12-W27
			900lm	3000K	acrylic	white	BATH12-W30
			920lm	4000K	acrylic	white	BATH12-W40
			960lm	6000K	acrylic	white	BATH12-W60
18W	>80	120°	1230lm	2700K	acrylic	white	BATH18-W27
			1250lm	3000K	acrylic	white	BATH18-W30
			1280lm	4000K	acrylic	white	BATH18-W40
			1320lm	6000K	acrylic	white	BATH18-W60

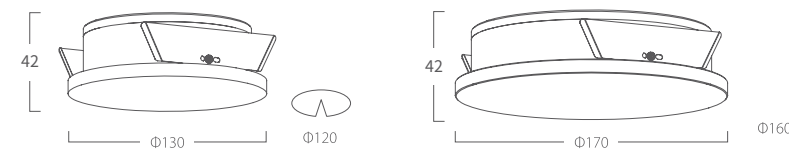

(mm)

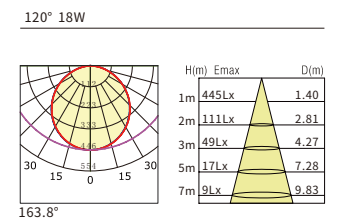
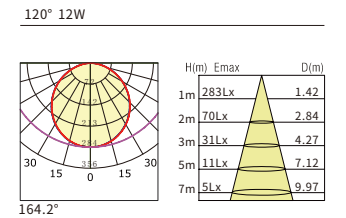

LED & Driver

SMD 2835:  
 Power: 0.2W/LED  
 Voltage: 3V-3.1V  
 SDCM<5  
 Philips Driver:  
 Input voltage: 100-240VAC  
 /220-240V/110-130V  
 Output:  
 12W-280mA 36-40V  
 18W-500mA 36-40V





Out

---

IP65

LED Type: SMD 2835 IP65 White as standard **Out**

Power	CRI	BeamAngle	Luminous Flux	CCT	Refractive screen	Frame	Model Number
9W	>80	90°	650lm	2700K	white	balck	OUT09-W27
			720lm	3000K	white	balck	OUT09-W30
			750lm	4000K	white	balck	OUT09-W40
			780lm	6000K	white	balck	OUT09-W60
15W	>80	90°	1180lm	2700K	white	balck	OUT15-W27
			1200lm	3000K	white	balck	OUT15-W30
			1220lm	4000K	white	balck	OUT15-W40
			1260lm	6000K	white	balck	OUT15-W60

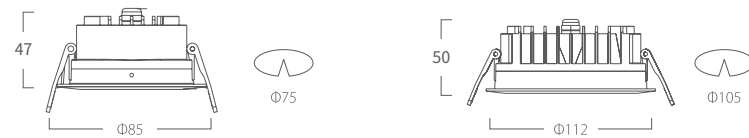

(mm)

90° 9W

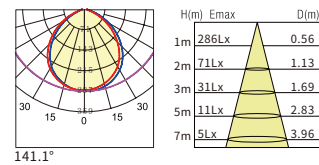

90° 15W

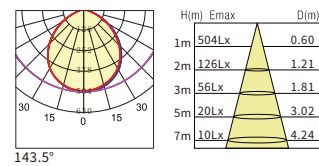

LED & Driver

SMD 2835:  
 Power: 0.2W/LED  
 Voltage: 3V-3.1V  
 SDCM<5  
 IP65 Driver:  
 Input voltage:100-240VAC  
 /220-240V/110-130V  
 Output:  
 9W-200mA 36V  
 15W-350mA 36V



LED Type: SMD 2835 IP65 White as standard **Out**

Power	CRI	BeamAngle	Luminous Flux	CCT	Refractive screen	Frame	Model Number
25W	>80	90°	1960lm	2700K	white	balck	OUT25-W27
			2000lm	3000K	white	balck	OUT25-W30
			2020lm	4000K	white	balck	OUT25-W40
			2050lm	6000K	white	balck	OUT25-W60
			2775lm	2700K	white	balck	OUT35-W27
35W	>80	90°	2800lm	3000K	white	balck	OUT35-W30
			2820lm	4000K	white	balck	OUT35-W40
			2850lm	6000K	white	balck	OUT35-W60

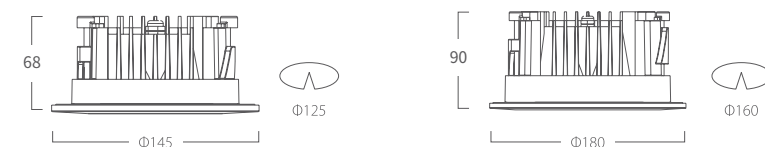

(mm)

90° 25W

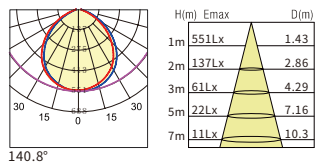

90° 35W

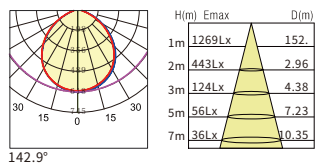

LED & Driver

SMD 2835:  
 Power: 0.2W/LED  
 Voltage: 3V-3.1V  
 SDCM<5  
 IP65 Driver:  
 Input voltage:100-240VAC  
 /220-240V/110-130V  
 Output:  
 25W-600mA 36V  
 35W-850mA 36V







# Slim

---

LED Type: CREE IP20 White as standard Slim

Power	CRI	BeamAngle	Luminous Flux	CCT	Refractive screen	Frame	Model Number
3W	>90	10°	225lm	2700K	white	balck	SLIM03-W2710
			225lm	3000K	white	balck	SLIM03-W3010
			225lm	4000K	white	balck	SLIM03-W4010
		20°	225lm	2700K	white	balck	SLIM03-W2720
			225lm	3000K	white	balck	SLIM03-W3020
			225lm	4000K	white	balck	SLIM03-W4020

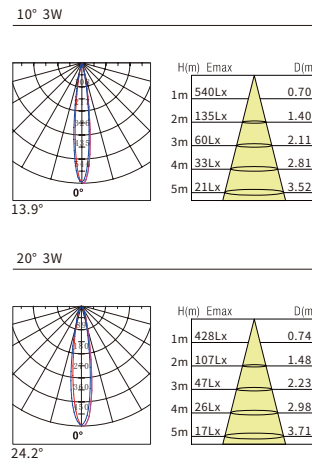

**LED & Driver**  
 CREE COB:  
 Power: 5W/LED  
 Voltage: 9V  
 SDCM<5  
 Philips Driver:  
 Input voltage:100-240VAC  
 /220-240V/110-130V  
 Output current:250mA  
 Output voltage:DC9V



LED Type: CREE IP20 White as standard Slim

Power	CRI	BeamAngle	Luminous Flux	CCT	Refractive screen	Frame	Model Number	
6W	>90	10°	430lm	2700K	white	balck	SLIM06-W2710	
			430lm	3000K	white	balck	SLIM06-W3010	
			430lm	4000K	white	balck	SLIM06-W4010	
			20°	430lm	2700K	white	balck	SLIM06-W2720
				430lm	3000K	white	balck	SLIM06-W3020
				430lm	4000K	white	balck	SLIM06-W4020
		36°	430lm	2700K	white	balck	SLIM06-W2736	
			430lm	3000K	white	balck	SLIM06-W3036	
			430lm	4000K	white	balck	SLIM06-W4036	

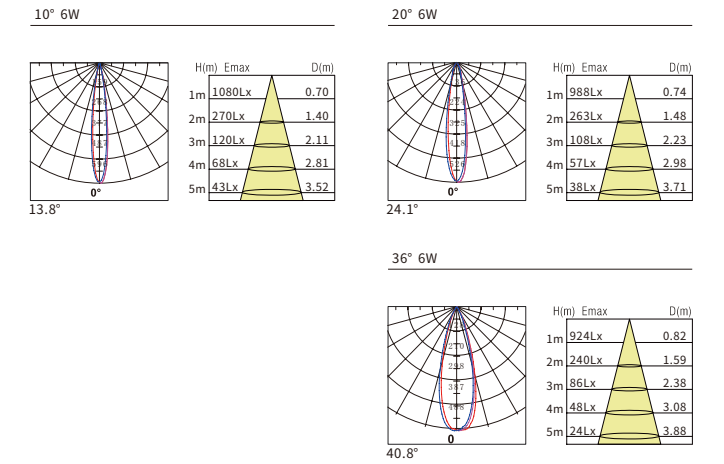
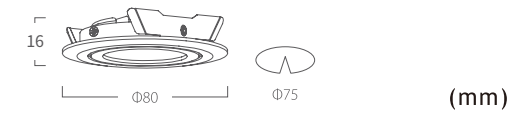

**LED & Driver**  
 CREE COB:  
 Power: 7W/LED  
 Voltage: 36V  
 SDCM<5  
 Philips Driver:  
 Input voltage:100-240VAC  
 /220-240V/110-130V  
 Output current:150mA  
 Output voltage:DC36-40V



LED Type: CREE IP20 White as standard Slim

Power	CRI	BeamAngle	Luminous Flux	CCT	Refractive screen	Frame	Model Number
8W	>90	10°	460lm	2700K	white	balck	Slim08-W2710
			460lm	3000K	white	balck	Slim08-W3010
			460lm	4000K	white	balck	Slim08-W4010
		20°	460lm	2700K	white	balck	Slim08-W2720
			460lm	3000K	white	balck	Slim08-W3020
			460lm	4000K	white	balck	Slim08-W4020
		36°	460lm	2700K	white	balck	Slim08-W2736
			460lm	3000K	white	balck	Slim08-W3036
			460lm	4000K	white	balck	Slim08-W4036

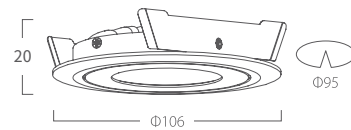

(mm)

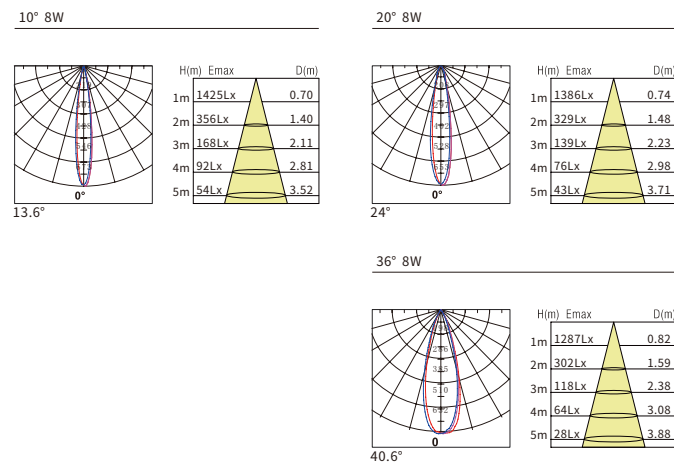

LED & Driver

CREE COB:  
 Power: 10W/LED  
 Voltage: 36V  
 SDCM<5  
 Philips Driver:  
 Input voltage:100-240VAC  
 /220-240V/110-130V  
 Output current:200mA  
 Output voltage:DC36-40V



LED Type: CREE IP20 White as standard Slim

Power	CRI	BeamAngle	Luminous Flux	CCT	Refractive screen	Frame	Model Number
12W	>90	10°	1000lm	2700K	white	balck	Slim12-W2710
			1000lm	3000K	white	balck	Slim12-W3010
			1000lm	4000K	white	balck	Slim12-W4010
		20°	1000lm	2700K	white	balck	Slim12-W2720
			1000lm	3000K	white	balck	Slim12-W3020
			1000lm	4000K	white	balck	Slim12-W4020
		36°	1000lm	2700K	white	balck	Slim12-W2736
			1000lm	3000K	white	balck	Slim12-W3036
			1000lm	4000K	white	balck	Slim12-W4036

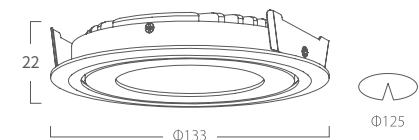

(mm)

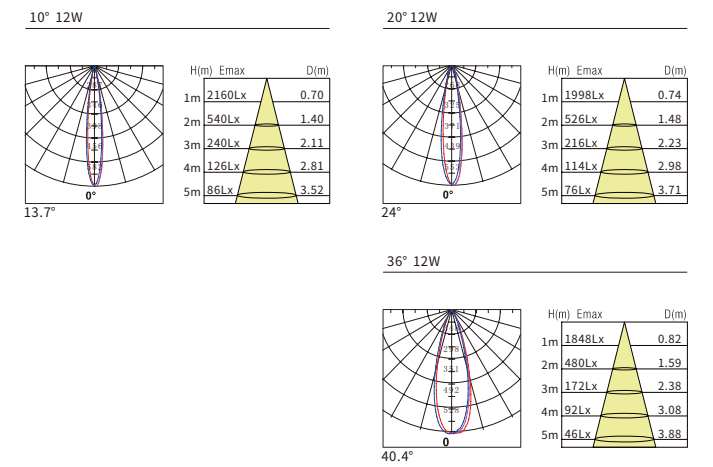

LED & Driver

CREE COB:  
 Power: 14W/LED  
 Voltage: 36V  
 SDCM<5  
 Philips Driver:  
 Input voltage:100-240VAC  
 /220-240V/110-130V  
 Output current:300mA  
 Output voltage:DC36-40V





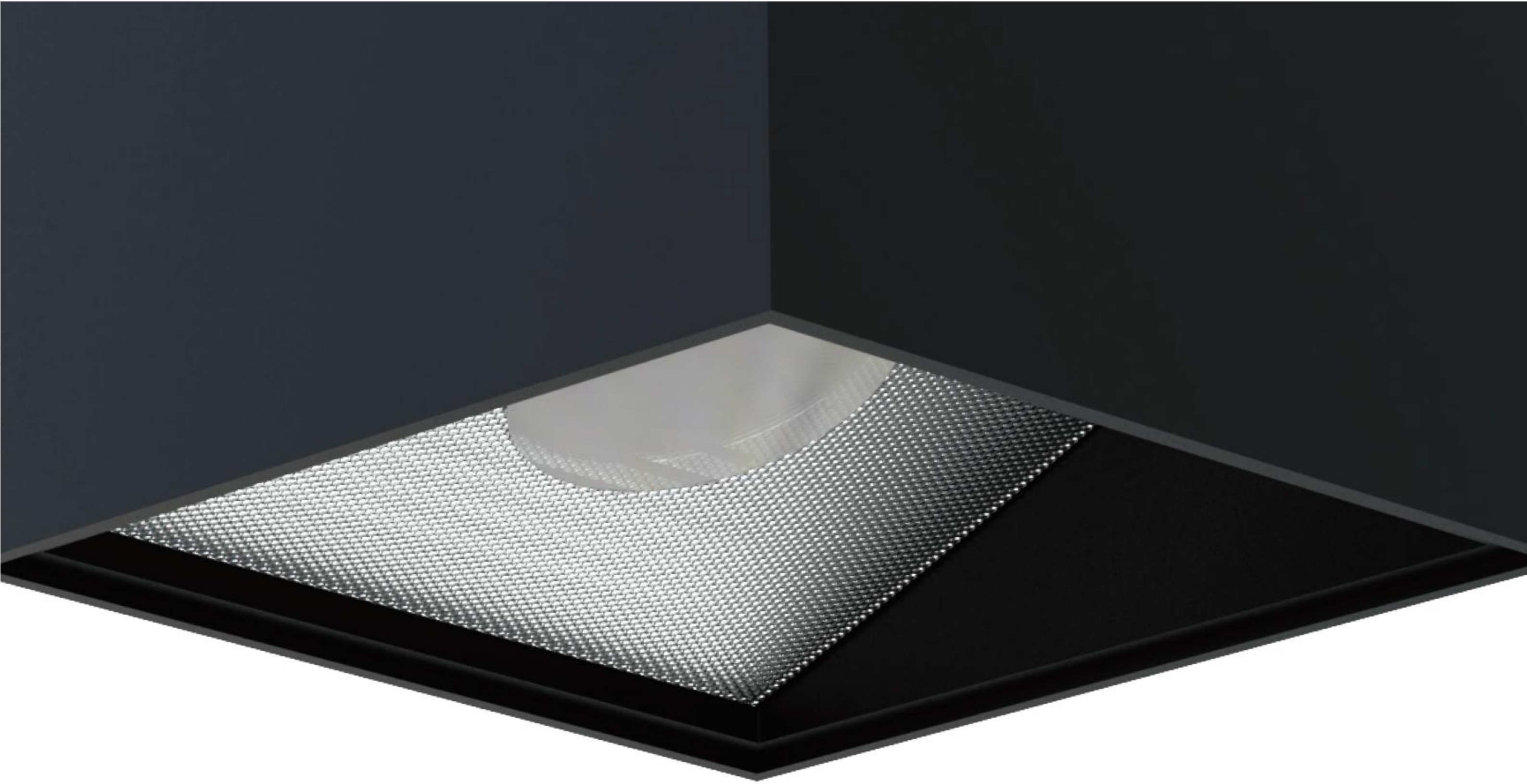

Duly

LED Type: Bridgelux IP20 White as standard

### Duly Recessed

Power	CRI	BeamAngle	Luminous Flux	CCT	Refractive screen	Frame	Model Number
12W	>90	15°	750lm	2700K	white	balck	DULYR12-W2715
			750lm	3000K	white	balck	DULYR12-W3015
			750lm	4000K	white	balck	DULYR12-W4015
		23°	750lm	2700K	white	balck	DULYR12-W2723
			750lm	3000K	white	balck	DULYR12-W3023
			750lm	4000K	white	balck	DULYR12-W4023
		38°	750lm	2700K	white	balck	DULYR12-W2738
			750lm	3000K	white	balck	DULYR12-W3038
			750lm	4000K	white	balck	DULYR12-W4038
		45°	750lm	2700K	white	balck	DULYR12-W2745
			750lm	3000K	white	balck	DULYR12-W3045
			750lm	4000K	white	balck	DULYR12-W4045
		60°	750lm	2700K	white	balck	DULYR12-W2760
			750lm	3000K	white	balck	DULYR12-W3060
			750lm	4000K	white	balck	DULYR12-W4060

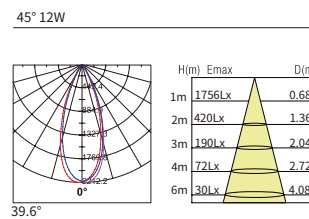
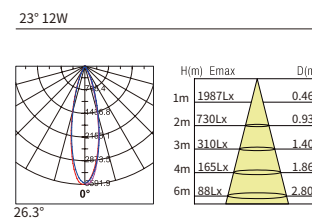
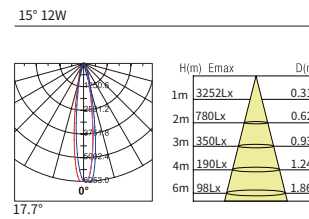
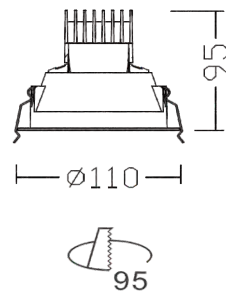

#### LED & Driver

Bridgelux COB  
 Power: 15W/LED  
 Voltage: 36V  
 SDCM<5  
 KEGU Driver:  
 Input voltage:100-240VAC  
 /220-240V/110-130V  
 Output current:200mA  
 Output voltage:DC27-40V



LED Type: Bridgelux IP20 White as standard

### Duly Recessed

Power	CRI	BeamAngle	Luminous Flux	CCT	Refractive screen	Frame	Model Number
12W	>90	15°	750lm	2700K	white	balck	DULYS12-W2715
			750lm	3000K	white	balck	DULYS12-W3015
			750lm	4000K	white	balck	DULYS12-W4015
		23°	750lm	2700K	white	balck	DULYS12-W2723
			750lm	3000K	white	balck	DULYS12-W3023
			750lm	4000K	white	balck	DULYS12-W4023
		38°	750lm	2700K	white	balck	DULYS12-W2738
			750lm	3000K	white	balck	DULYS12-W3038
			750lm	4000K	white	balck	DULYS12-W4038
		45°	750lm	2700K	white	balck	DULYS12-W2745
			750lm	3000K	white	balck	DULYS12-W3045
			750lm	4000K	white	balck	DULYS12-W4045
		60°	750lm	2700K	white	balck	DULYS12-W2760
			750lm	3000K	white	balck	DULYS12-W3060
			750lm	4000K	white	balck	DULYS12-W4060

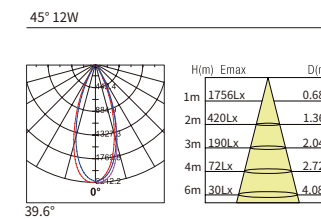
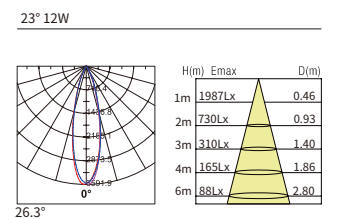
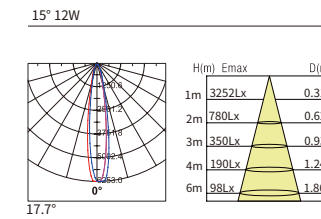
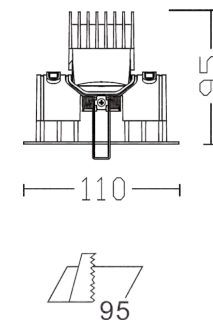

#### LED & Driver



Bridgelux COB  
 Power: 15W/LED  
 Voltage: 36V  
 SDCM<5  
 KEGU Driver:  
 Input voltage:100-240VAC  
 /220-240V/110-130V  
 Output current:200mA  
 Output voltage:DC27-40V



LED Type: Bridgelux IP20 White as standard

### Duly Surface



Power	CRI	BeamAngle	Luminous Flux	CCT	Housing	Model Number
15W	>90	15°	750lm	2700K	white	DULYR15-W2715
			750lm	3000K	white	DULYR15-W3015
			750lm	4000K	black	DULYR15-B4015
		23°	750lm	2700K	white	DULYR15-W2723
			750lm	3000K	black	DULYR15-B3023
			750lm	4000K	white	DULYR15-W4023
		38°	750lm	2700K	black	DULYR15-B2738
			750lm	3000K	white	DULYR15-W3038
			750lm	4000K	white	DULYR15-W4038
		45°	750lm	2700K	white	DULYR15-W2745
			750lm	3000K	black	DULYR15-B3045
			750lm	4000K	white	DULYR15-W4045
		60°	750lm	2700K	white	DULYR15-W2760
			750lm	3000K	white	DULYR15-W3060
			750lm	4000K	black	DULYR15-B4060

LED Type: Bridgelux IP20 White as standard

### Duly Surface

Power	CRI	BeamAngle	Luminous Flux	CCT	Housing	Model Number
15W	>90	15°	750lm	2700K	white	DULYS15-W2715
			750lm	3000K	white	DULYS15-W3015
			750lm	4000K	black	DULYS15-B4015
		23°	750lm	2700K	white	DULYS15-W2723
			750lm	3000K	black	DULYS15-B3023
			750lm	4000K	white	DULYS15-W4023
		38°	750lm	2700K	black	DULYS15-B2738
			750lm	3000K	white	DULYS15-W3038
			750lm	4000K	white	DULYS15-W4038
		45°	750lm	2700K	white	DULYS15-W2745
			750lm	3000K	black	DULYS15-B3045
			750lm	4000K	white	DULYS15-W4045
		60°	750lm	2700K	white	DULYS15-W2760
			750lm	3000K	white	DULYS15-W3060
			750lm	4000K	black	DULYS15-B4060

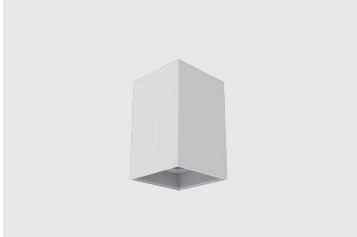
LED & Driver

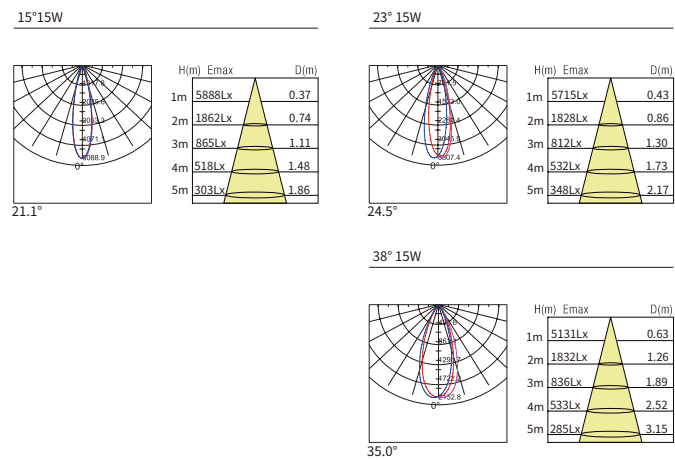
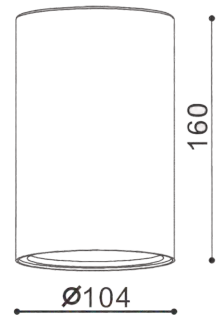
Bridgelux COB  
 Power: 16W/LED  
 Voltage: 36V  
 SDCM<5  
 MEANWELL Driver:  
 Input voltage:100-240VAC  
 /220-240V/110-130V  
 Output current:200mA  
 Output voltage:DC27-40V

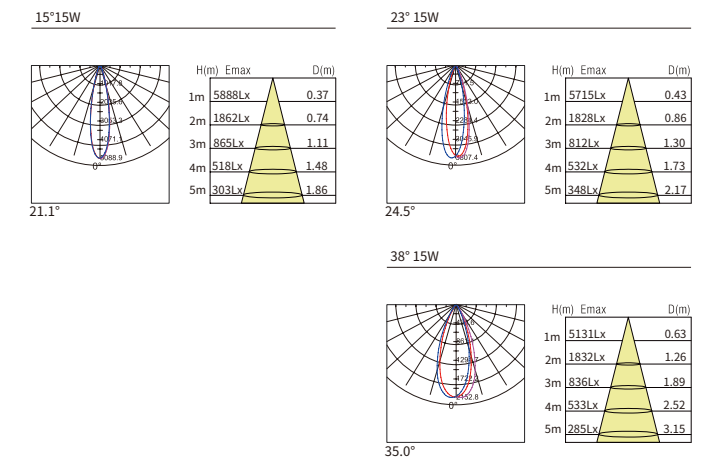
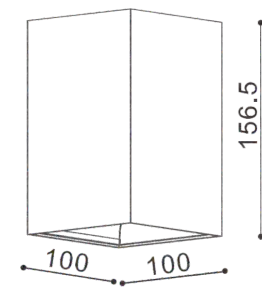

LED & Driver

Bridgelux COB  
 Power: 16W/LED  
 Voltage: 36V  
 SDCM<5  
 MEANWELL Driver:  
 Input voltage:100-240VAC  
 /220-240V/110-130V  
 Output current:250mA  
 Output voltage:DC27-40V







Round



LED Type Philips IP20  White as standard **Round Surface**

Power	CRI	Beam Angle	Luminous Flux	CCT	Refractive screen	Frame	Model Number
12W	>90	24°	1000lm	2700K	white	white	ROUS12-W2724
			1000lm	3000K	white	white	ROUS12-W3024
			1000lm	4000K	white	white	ROUS12-W4024
			1000lm	2700K	balck	balck	ROUS12-B2724
			1000lm	3000K	balck	balck	ROUS12-B3024
			1000lm	4000K	balck	balck	ROUS12-B4024

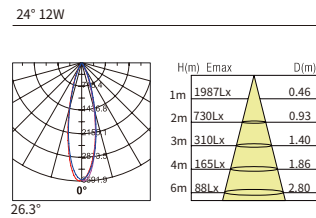
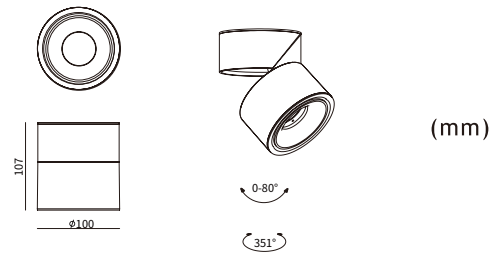

LED & Driver

Philips COB  
 Power: 13W/LED  
 Voltage: 36V  
 SDCM<5  
 Coic Driver:  
 Input voltage:100-240VAC  
 /220-240V/110-130V  
 Output current:300mA  
 Output voltage:DC25-42V



LED Type Philips IP20  White as standard **Round Track**

Power	CRI	Beam Angle	Luminous Flux	CCT	Refractive screen	Frame	Model Number
12W	>90	24°	1000lm	2700K	white	white	ROUT12-W2724
			1000lm	3000K	white	white	ROUT12-W3024
			1000lm	4000K	white	white	ROUT12-W4024
			1000lm	2700K	balck	balck	ROUT12-B2724
			1000lm	3000K	balck	balck	ROUT12-B3024
			1000lm	4000K	balck	balck	ROUT12-B4024

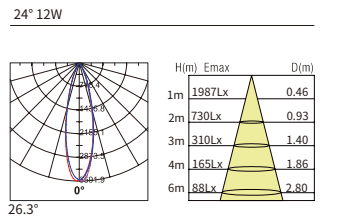
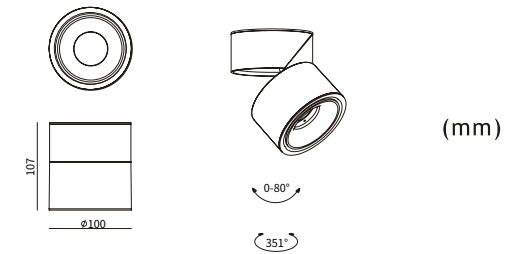
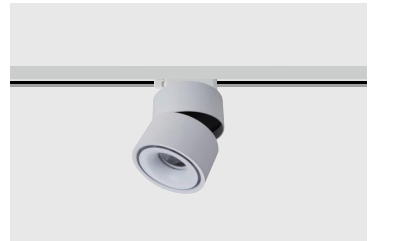

LED & Driver

Philips COB  
 Power: 13W/LED  
 Voltage: 36V  
 SDCM<5  
 Coic Driver:  
 Input voltage:100-240VAC  
 /220-240V/110-130V  
 Output current:300mA  
 Output voltage:DC25-42V







**Raster** | Wallwasher



LED Type: OSRAM IP65 Deep grey as standard **Luce**

Power	CRI	Beam Angle	Luminous Flux	CCT	Refractive screen	Housing	Model Number
9W	>90	15°	540lm	2700K	black	grey	LU09-G2715
			600lm	3000K	black	grey	LU09-G3015
			650lm	4000K	black	grey	LU09-G4015
			720lm	6000K	black	grey	LU09-G6015
		30°	540lm	2700K	black	grey	LU09-G2730
			600lm	3000K	black	grey	LU09-G3030
			650lm	4000K	black	grey	LU09-G4030
			720lm	6000K	black	grey	LU09-G6030
		45°	540lm	2700K	black	grey	LU09-G2745
			600lm	3000K	black	grey	LU09-G3045
			650lm	4000K	black	grey	LU09-G4045
			720lm	6000K	black	grey	LU09-G6045

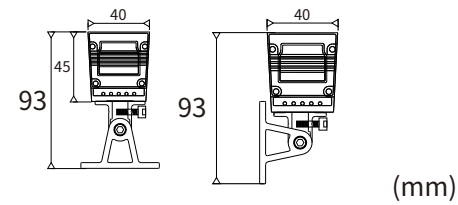
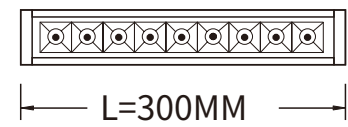

Installation

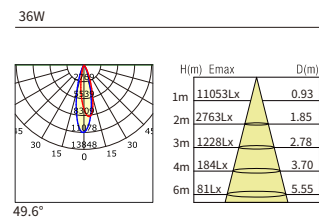
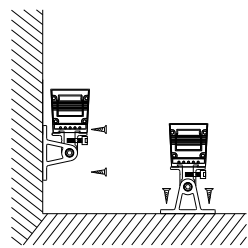

LED & Driver

Osram smd3030:  
Power: 1W/LED  
Voltage: DC24V  
SDCM<5  
MEANWELL Driver:  
Input Voltage:85-265VAC  
/220-240V/110-130V  
Output Voltage:DC24V  
Power:100-350W



G.W.:10kgs  
Packaging:30x27x22cm,20PCS/CTN



LED Type: OSRAM IP65 Deep grey as standard **Luce**

Power	CRI	Beam Angle	Luminous Flux	CCT	Refractive screen	Housing	Model Number
18W	>90	15°	1080lm	2700K	black	grey	LU18-G2715
			1200lm	3000K	black	grey	LU18-G3015
			1300lm	4000K	black	grey	LU18-G4015
			1440lm	6000K	black	grey	LU18-G6015
		30°	1080lm	2700K	black	grey	LU18-G2730
			1200lm	3000K	black	grey	LU18-G3030
			1300lm	4000K	black	grey	LU18-G4030
			1440lm	6000K	black	grey	LU18-G6030
		45°	1080lm	2700K	black	grey	LU18-G2745
			1200lm	3000K	black	grey	LU18-G3045
			1300lm	4000K	black	grey	LU18-G4045
			1440lm	6000K	black	grey	LU18-G6045

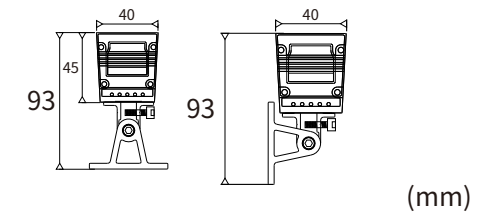
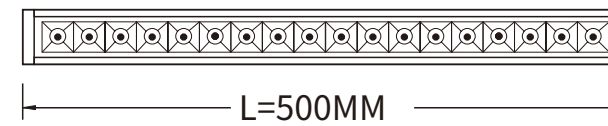

Installation

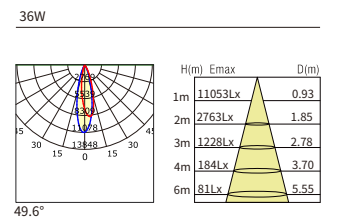
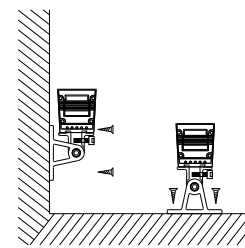

LED & Driver

Osram smd3030:  
Power: 1W/LED  
Voltage: DC24V  
SDCM<5  
MEANWELL Driver:  
Input Voltage:85-265VAC  
/220-240V/110-130V  
Output Voltage:DC24V  
Power:100-350W



G.W.:14.5kgs  
Packaging:53x27x18cm,15PCS/CTN



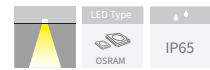

● Deep grey as standard

Luce

Power	CRI	Beam Angle	Luminous Flux	CCT	Refractive screen	Housing	Model Number
36W	>90	15°	1620lm	2700K	black	grey	LU36-G2715
			1800lm	3000K	black	grey	LU36-G3015
			1950lm	4000K	black	grey	LU36-G4015
			2160lm	6000K	black	grey	LU36-G6015
		30°	1620lm	2700K	black	grey	LU36-G2730
			1800lm	3000K	black	grey	LU36-G3030
			1950lm	4000K	black	grey	LU36-G4030
			2160lm	6000K	black	grey	LU36-G6030
		45°	1620lm	2700K	black	grey	LU36-G2745
			1800lm	3000K	black	grey	LU36-G3045
			1950lm	4000K	black	grey	LU36-G4045
			2160lm	6000K	black	grey	LU36-G6045

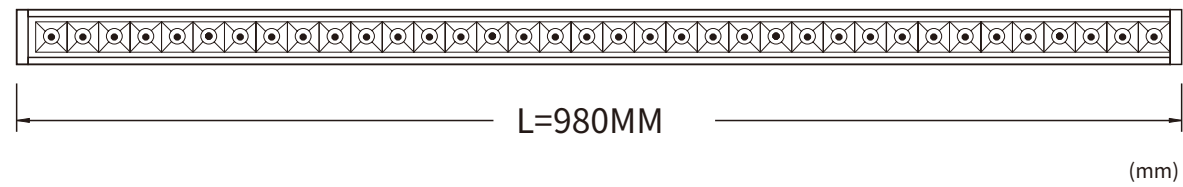
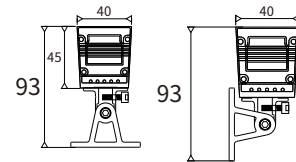

### Installation

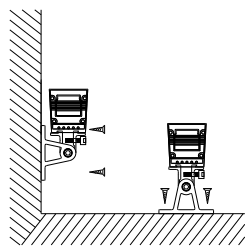

36W

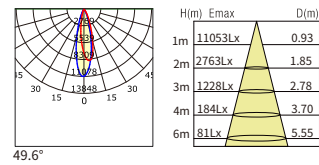

### LED & Driver

Osram smd3030:  
 Power: 1W/LED  
 Voltage: DC24V  
 SDCM<5  
 MEANWELL Driver:  
 Input Voltage:85-265VAC  
 /220-240V/110-130V  
 Output Voltage:DC24V  
 Power:100-350W



G.W.:19kgs  
 Packaging:100x27x12cm,10PCS/CTN

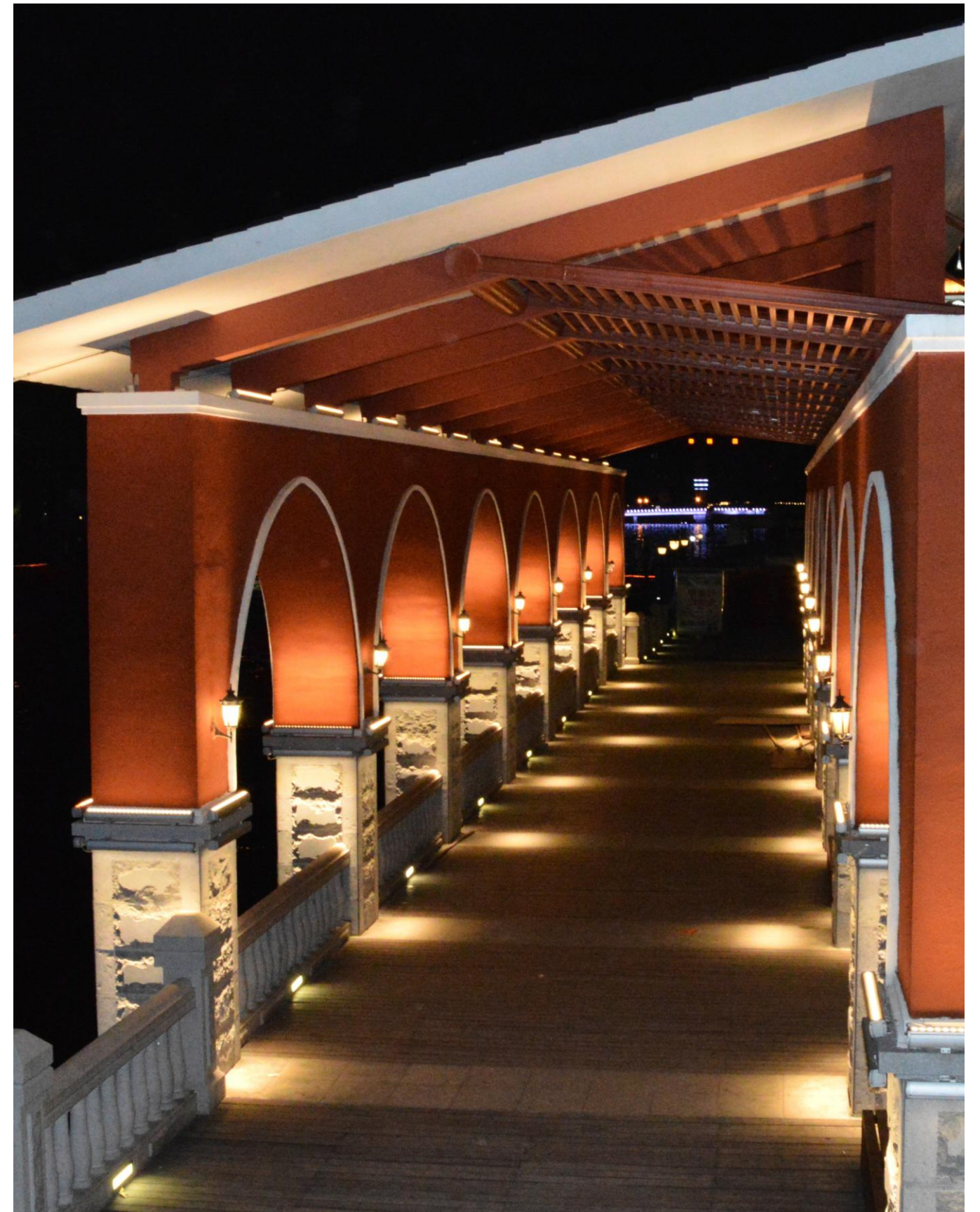



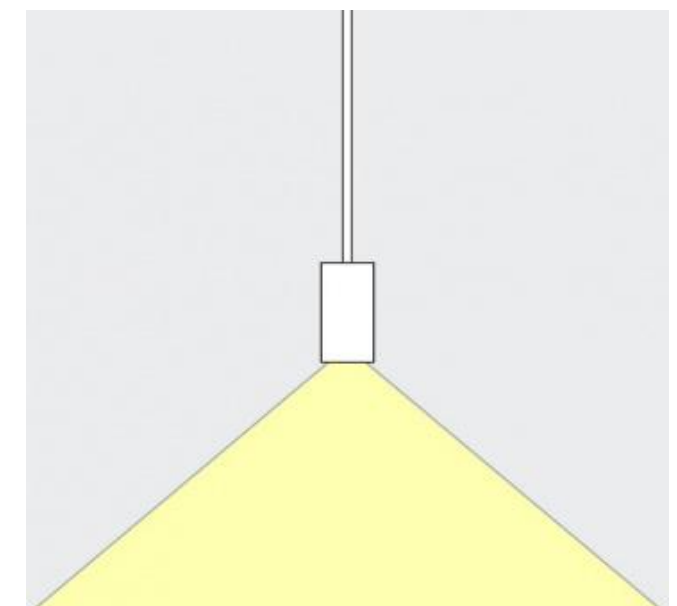
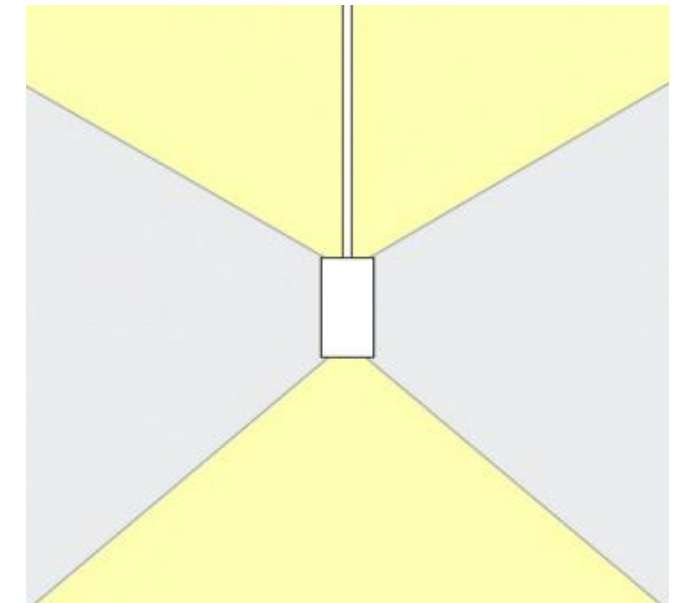

## VISUAL COMFORT DIRECT/INDIRECT

HIGHLY DIVERSE PENDANT LUMINAIRE WITH LINEAR PROFILES AND DIRECT/INDIRECT ILLUMINATION. OFI CAN BE MODIFIED CONTINUOUSLY FROM 3000K TO 6000K. THIS ENABLES THE LIGHT ATMOSPHERE IN THE ROOM TO BE ADAPTED TO DAYLIGHT OR PERSONAL MOODS.



LED Type: OSRAM IP23 ●○ Black or white as standard OFI

Power	CRI	Beam Angle	Luminous Flux	CCT	Refractive screen	Frame	Model Number
30W	>90	12°	2100lm	2700K	black	white	OFI31-W2712
			2150lm	3000K	black	black	OFI31-B3012
			2250lm	4000K	black	white	OFI31-W4012
		36°	2100lm	2700K	black	black	OFI31-B2736
			2150lm	3000K	black	white	OFI31-W3036
			2250lm	4000K	black	black	OFI31-B4036
		48°	2100lm	2700K	black	white	OFI31-W2748
			2150lm	3000K	black	black	OFI31-B3048
			2250lm	4000K	black	white	OFI31-W4048



LED Type: OSRAM IP23 ●○ Black or white as standard OFI

Power	CRI	Beam Angle	Luminous Flux	CCT	Refractive screen	Frame	Model Number
30W down+ 15W up	>90	12°	2100lm	2700K	black	white	OFI31U-W2712
			2150lm	3000K	black	black	OFI31U-B3012
			2250lm	4000K	black	white	OFI31U-W4036
		36°	2100lm	2700K	black	black	OFI31U-B2736
			2150lm	3000K	black	white	OFI31U-W3036
			2250lm	4000K	black	black	OFI31U-B4036
		48°	2100lm	2700K	black	white	OFI31U-W2748
			2150lm	3000K	black	black	OFI31U-B3048
			2250lm	4000K	black	white	OFI31U-W4048

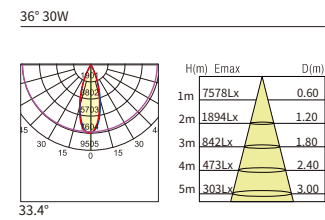
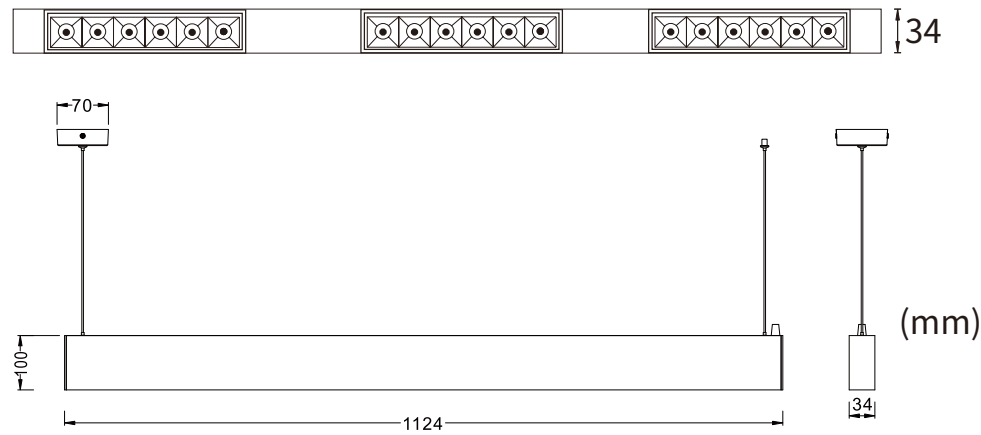



LED & Driver

Luminus smd3030:  
 Power: 1-3W/LED  
 Voltage: 3V  
 SDCM<5  
 Driver:  
 Input Voltage:220-240VAC  
 Output Current:1050mA  
 Output Voltage:DC30-43V

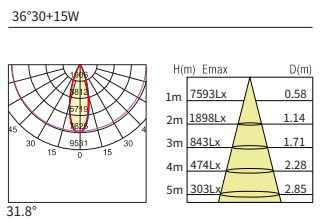
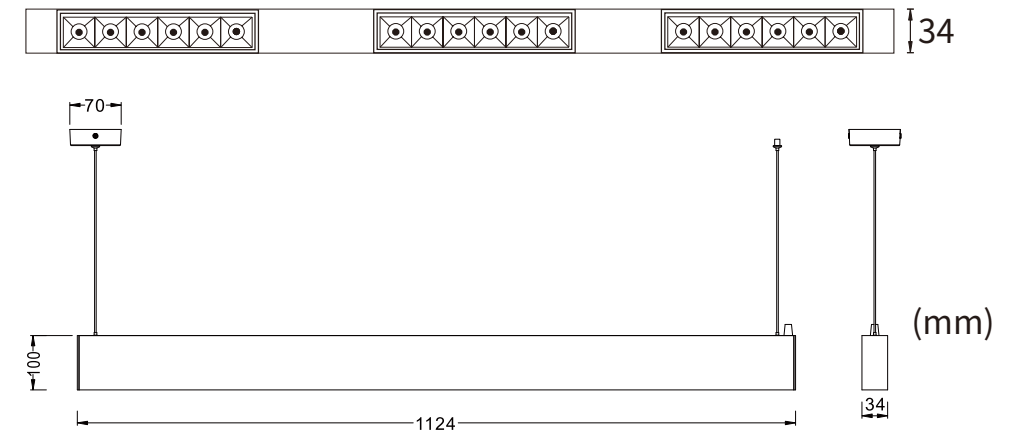

G.W.:15.60kgs  
 Packaging:132x36x16cm,5PCS/CTN



LED & Driver

Luminus smd3030:  
 Power: 1-3W/LED  
 Voltage: 3V  
 SDCM<5  
 Driver:  
 Input Voltage:220-240VAC  
 Output Current:1050mA  
 Output Voltage:DC30-43V



G.W.:15.60kgs  
 Packaging:131.5x22.5x12.6cm,5PCS/CTN



LED Type: OSRAM IP23 ●○ Black or white as standard OFI

Power	CRI	Beam Angle	Luminous Flux	CCT	Refractive screen	Frame	Model Number
30W	>90	12°	2100lm	3000K	black	white	OFI33-W2712
			2150lm	4000K	black	black	OFI33-B3012
			2250lm	5000K	black	white	OFI33-W4012
		36°	2100lm	3000K	black	black	OFI33-B2736
			2150lm	4000K	black	white	OFI33-W3036
			2250lm	5000K	black	black	OFI33-B4036
48°	2100lm	3000K	black	white	OFI33-W2748		
	2150lm	4000K	black	black	OFI33-B3048		
	2250lm	5000K	black	white	OFI33-W4048		

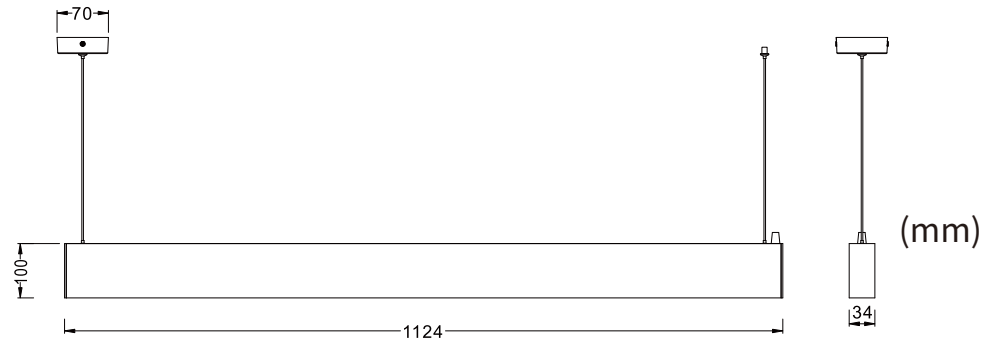

LED & Driver

Luminus smd3030:  
 Power: 1-3W/LED  
 Voltage: 3V  
 SDCM<5  
 Driver:  
 Input Voltage:220-240VAC  
 Output Current:1050mA  
 Output Voltage:DC30-43V

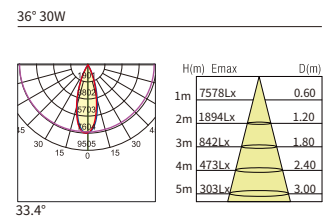

G.W.:15.60kgs  
 Packaging:131.5x22.5x12.6cm,5PCS/CTN



LED Type: OSRAM IP23 ●○ Black or white as standard OFI

Power	CRI	Beam Angle	Luminous Flux	CCT	Refractive screen	Frame	Model Number
30W down+ 15W up	>90	12°	2100lm	3000K	black	white	OFI323U-W2712
			2150lm	4000K	black	black	OFI33U-B3012
			2250lm	5000K	black	white	OFI33U-W4012
		36°	2100lm	3000K	black	black	OFI33U-B2736
			2150lm	4000K	black	white	OFI33U-W3036
			2250lm	5000K	black	black	OFI33U-B4036
48°	2100lm	3000K	black	white	OFI33U-W2748		
	2150lm	4000K	black	black	OFI33U-B3048		
	2250lm	5000K	black	white	OFI33U-W4048		

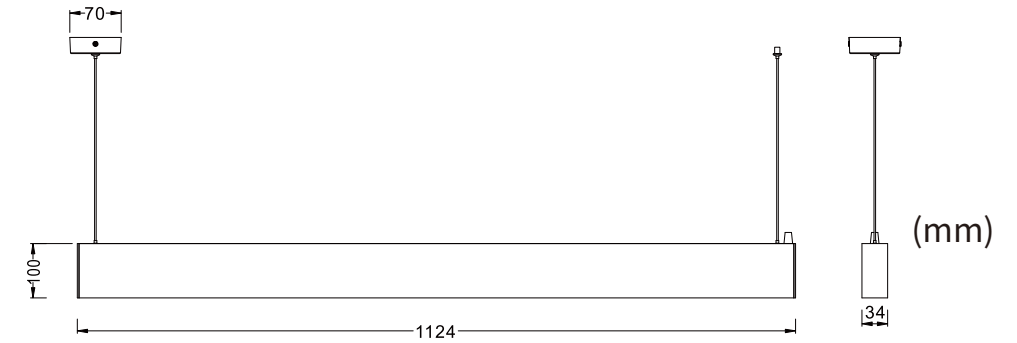

LED & Driver

Luminus smd3030:  
 Power: 1-3W/LED  
 Voltage: 3V  
 SDCM<5  
 Driver:  
 Input Voltage:220-240VAC  
 Output Current:1050mA  
 Output Voltage:DC30-43V

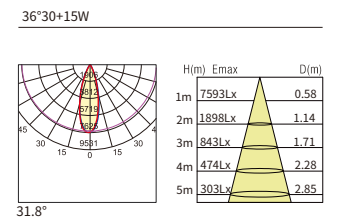

G.W.:15.60kgs  
 Packaging:131.5x22.5x12.6cm,5PCS/CTN



LED Type: OSRAM IP23 ●○ Black or white as standard OFI

Power	CRI	Beam Angle	Luminous Flux	CCT	Refractive screen	Frame	Model Number
30W	>90	12°	2100lm	3000K	black	white	OFI32-W2712
			2150lm	4000K	black	black	OFI32-B3012
			2250lm	5000K	black	white	OFI32-W4012
		36°	2100lm	3000K	black	black	OFI32-B2736
			2150lm	4000K	black	white	OFI32-W3036
			2250lm	5000K	black	black	OFI32-B4036
48°	2100lm	3000K	black	white	OFI32-W2748		
	2150lm	4000K	black	black	OFI32-B3048		
	2250lm	5000K	black	white	OFI32-W4048		

LED Type: OSRAM IP23 ●○ Black or white as standard OFI

Power	CRI	Beam Angle	Luminous Flux	CCT	Refractive screen	Frame	Model Number
30W down+ 15W up	>90	12°	2100lm	3000K	black	white	OFI32U-W2712
			2150lm	4000K	black	black	OFI32U-B3012
			2250lm	5000K	black	white	OFI32U-W4012
		36°	2100lm	3000K	black	black	OFI32U-B2736
			2150lm	4000K	black	white	OFI32U-W3036
			2250lm	5000K	black	black	OFI32U-B4036
48°	2100lm	3000K	black	white	OFI32U-W2748		
	2150lm	4000K	black	black	OFI32U-B3048		
	2250lm	5000K	black	white	OFI32U-W4048		

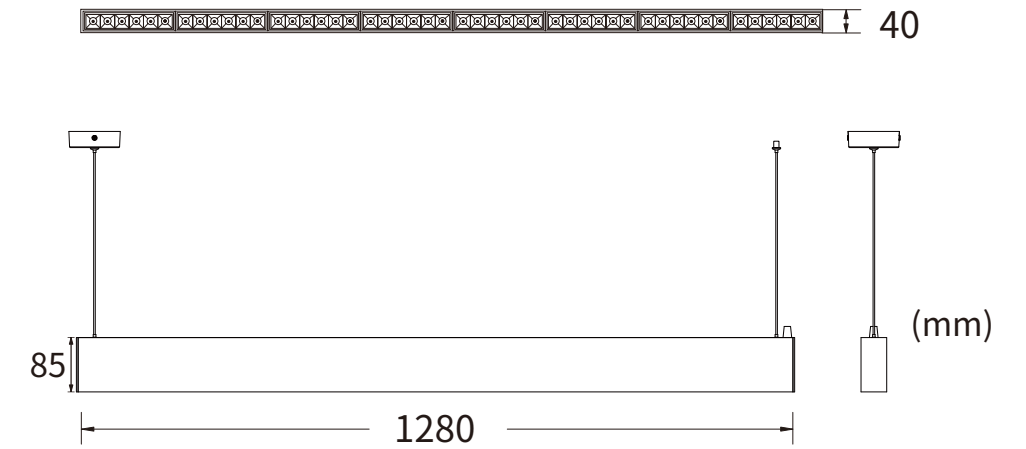
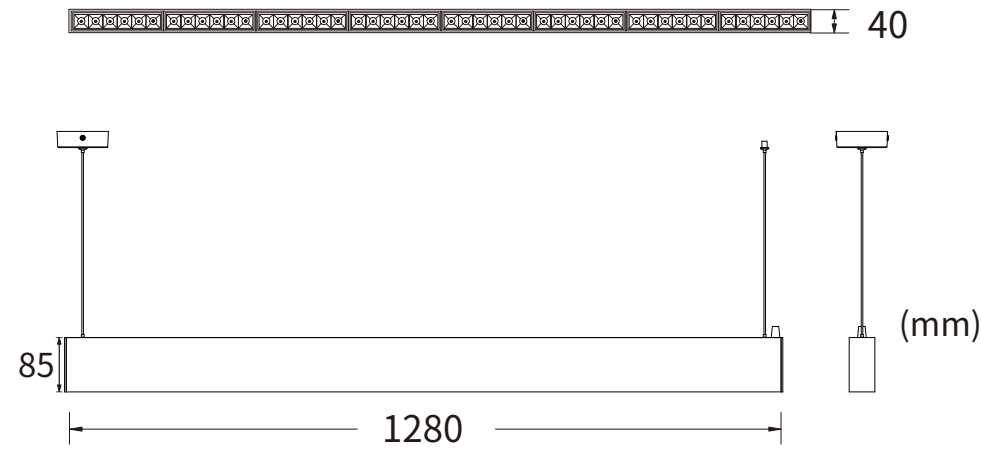

LED & Driver

Luminus smd3030:  
Power: 1-3W/LED  
Voltage: 3V  
SDCM<5  
Driver:  
Input Voltage:220-240VAC  
Output Current:1050mA  
Output Voltage:DC30-43V



36° 30W

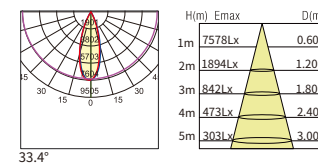

G.W.:15.60kgs  
Packaging:131.5x22.5x12.6cm,5PCS/CTN



LED & Driver

Luminus smd3030:  
Power: 1-3W/LED  
Voltage: 3V  
SDCM<5  
Driver:  
Input Voltage:220-240VAC  
Output Current:1050mA  
Output Voltage:DC30-43V



36°30+15W

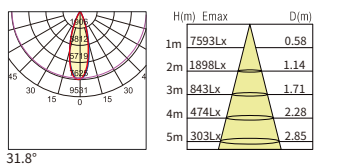

G.W.:15.60kgs  
Packaging:131.5x22.5x12.6cm,5PCS/CTN







LED Type  
Cree  
Ip23  
IP44 for visible  
body of fitting  
after installation

●○ Black or white as standard

DOT

Power	CRI	Beam Angle	Luminous Flux	CCT	Refractive screen	Frame	Model Number
3W	>90	15°	240lm	2700K	black	white	DOT03-WB2715
			240lm	3000K	red	white	DOT03-WR3015
			240lm	4000K	gold	white	DOT03-WO4015
		24°	240lm	2700K	silver	white	DOT03-WS2724
			240lm	3000K	grey	white	DOT03-WG3024
			240lm	4000K	black	white	DOT03-WB4024
		36°	240lm	2700K	black	white	DOT03-WB2736
			240lm	3000K	black	white	DOT03-WB3036
			240lm	4000K	black	white	DOT03-WB4036

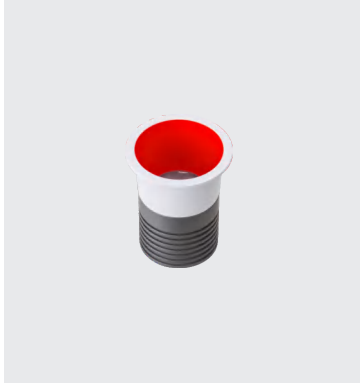

LED Type  
Cree  
Ip23  
IP44 for visible  
body of fitting  
after installation

●○ Black or white as standard

DOT

Power	CRI	Beam Angle	Luminous Flux	CCT	Refractive screen	Frame	Model Number	
8W	>90	15°	640lm	2700K	black	white	DOT08-WB2715	
			640lm	3000K	red	white	DOT08-WR3015	
			640lm	4000K	gold	white	DOT08-WO4015	
			640lm	2700K	silver	white	DOT08-WS2724	
			640lm	3000K	grey	white	DOT08-WG3024	
			640lm	4000K	black	white	DOT08-WB4024	
		24°	640lm	2700K	black	white	DOT08-WB2736	
			640lm	3000K	black	white	DOT08-WB3036	
			640lm	4000K	black	white	DOT08-WB4036	
			36°	640lm	2700K	black	white	DOT08-WB2736
				640lm	3000K	black	white	DOT08-WB3036
				640lm	4000K	black	white	DOT08-WB4036

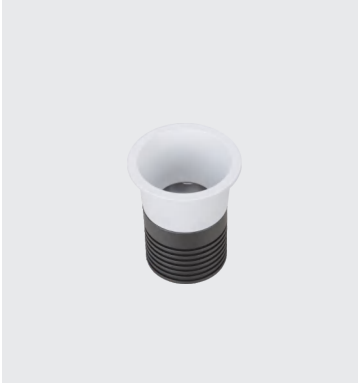
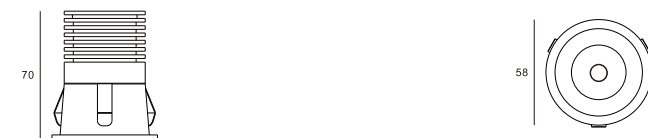
### Reflector

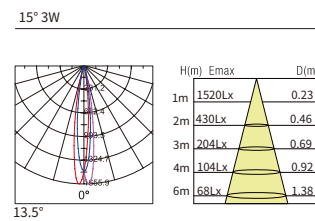
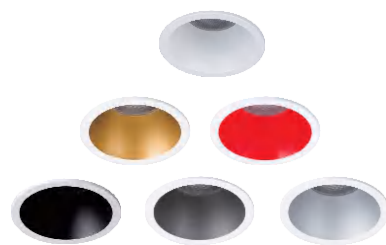

### Reflector

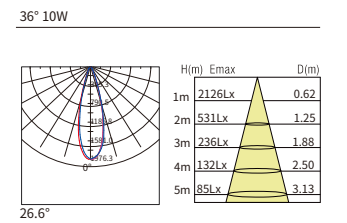
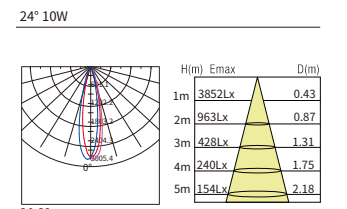
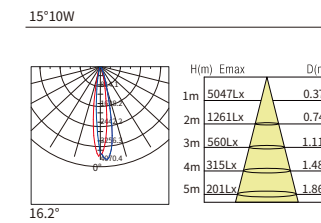

### LED & Driver

Cree COB  
 Power: 3-5W/LED  
 Voltage: 3-8V  
 SDCM<5  
 Driver:  
 Input Voltage:100-277VAC  
 /220-240VAC  
 Output Current:250mA  
 Output Voltage:DC3-8V



G.W.:12kgs  
 Packaging:47x37x37cm,100PCS/CTN



### LED & Driver

Cree COB  
 Power: 7-10W/LED  
 Voltage: 36V  
 SDCM<5  
 Driver:  
 Input Voltage:100-277VAC  
 /220-240VAC  
 Output Current:250mA  
 Output Voltage:DC28-40V



G.W.:17.80kgs  
 Packaging:52x42x37cm,100PCS/CTN





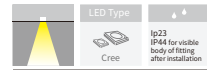

●○ Black or white as standard

DOT

Power	CRI	Beam Angle	Luminous Flux	CCT	Refractive screen	Frame	Model Number
12W	>90	15°	960lm	2700K	black	white	DOT12-WB2715
			960lm	3000K	red	white	DOT12-WR3015
			960lm	4000K	gold	white	DOT12-WO4015
		24°	960lm	2700K	silver	white	DOT12-WS2724
			960lm	3000K	grey	white	DOT12-WG3024
			960lm	4000K	black	white	DOT12-WB4024
		36°	960lm	2700K	black	white	DOT12-WB2736
			960lm	3000K	black	white	DOT12-WB3036
			960lm	4000K	black	white	DOT12-WB4036

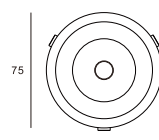
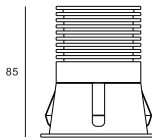
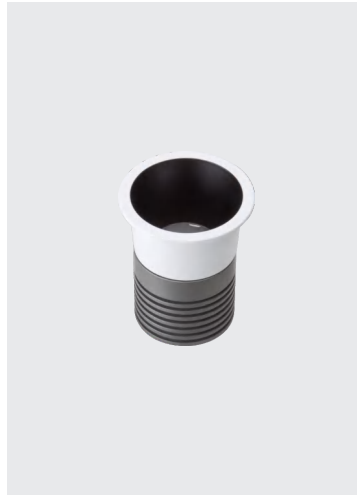

Filter

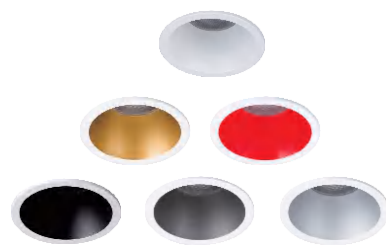

15° 12W

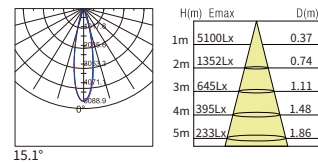

24° 12W

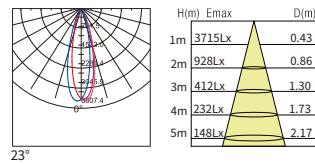

36° 12W

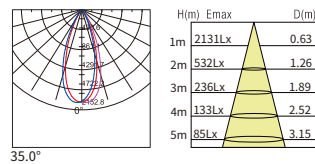

LED & Driver

Cree COB  
 Power: 12-15W/LED  
 Voltage: 36V  
 SDCM<5  
 Driver:  
 Input Voltage:100-277VAC /220-240VAC  
 Output Current:250mA  
 Output Voltage:DC28-40V



G.W.:13.5kgs  
 Packaging:57x57x25cm,50PCS/CTN

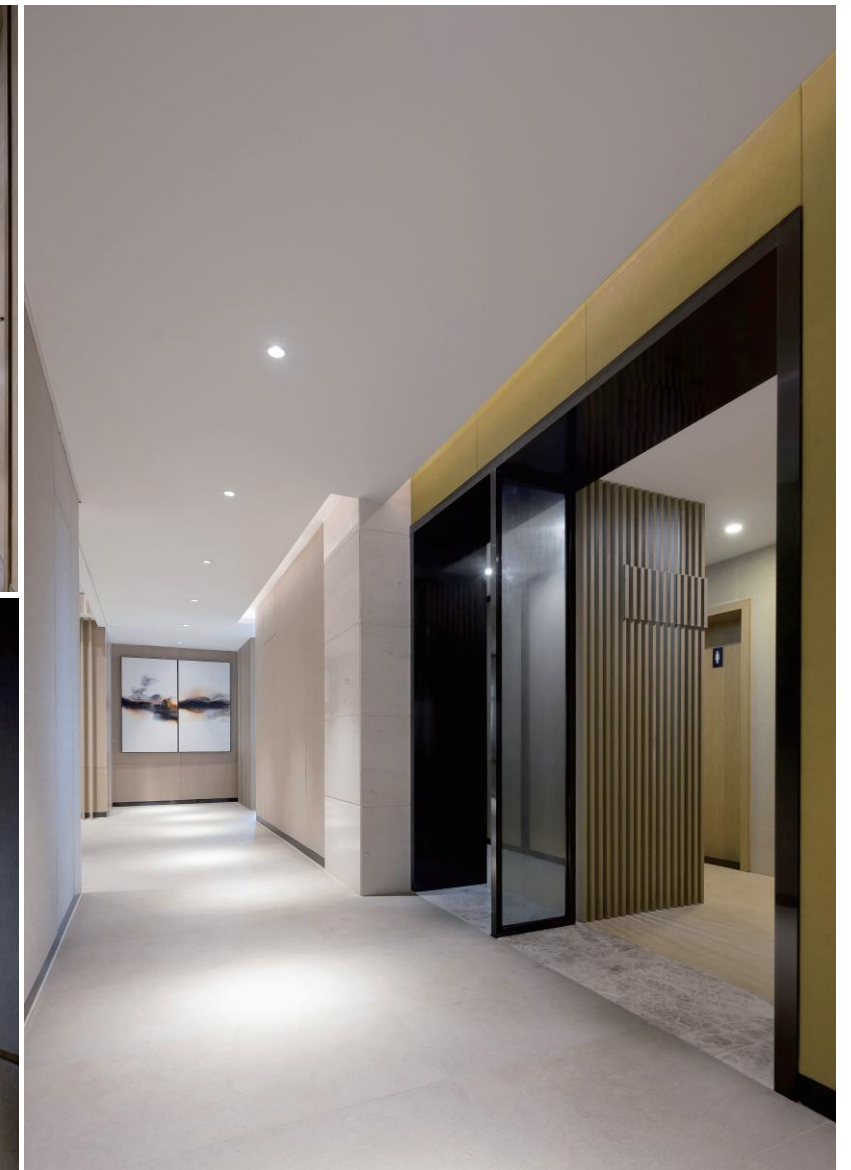
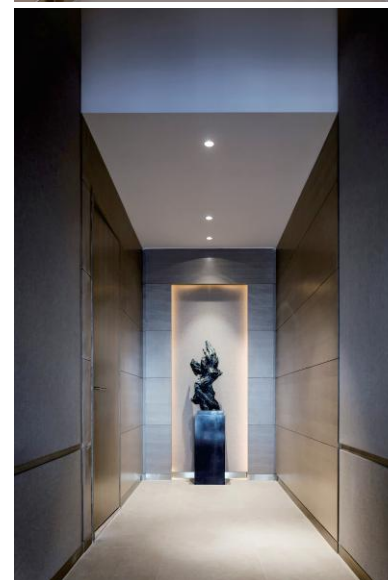



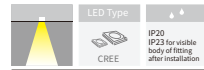

○ White as standard

Dot

Power	CRI	Beam Angle	Luminous Flux	CCT	Refractive screen	Frame	Model Number
2W	>90	15°	160lm	2700K	black	white	DOT-WB2715
			170lm	3000K	black	black	DOT-BB3015
			180lm	4000K	black	white	DOT-WB4015
		20°	160lm	2700K	white	black	DOT-BW2720
			170lm	3000K	silver	white	DOT-WS3020
			180lm	4000K	red	black	DOT-BR4020
30°	160lm	2700K	golden	white	DOT-WG2730		
	170lm	3000K	golden	black	DOT-BG3030		
	180lm	4000K	red	white	DOT-WG4030		

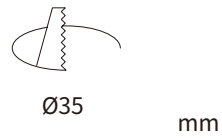

Reflector Cover

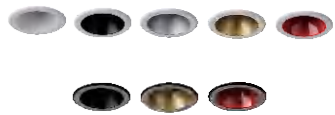

LED & Driver

Osram/CREE COB:  
 Power: 3W/LED  
 Voltage: 3V  
 SDCM<5  
 Driver:  
 Input Voltage:220-240VAC  
 Output Current:500mA  
 Output Voltage:DC2.2-4.2V

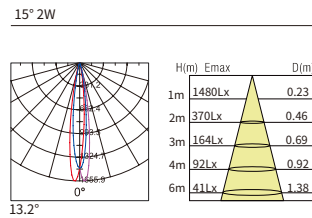

G.W.:12.00kgs  
 Packaging:47x37x37cm,100PCS/CTN

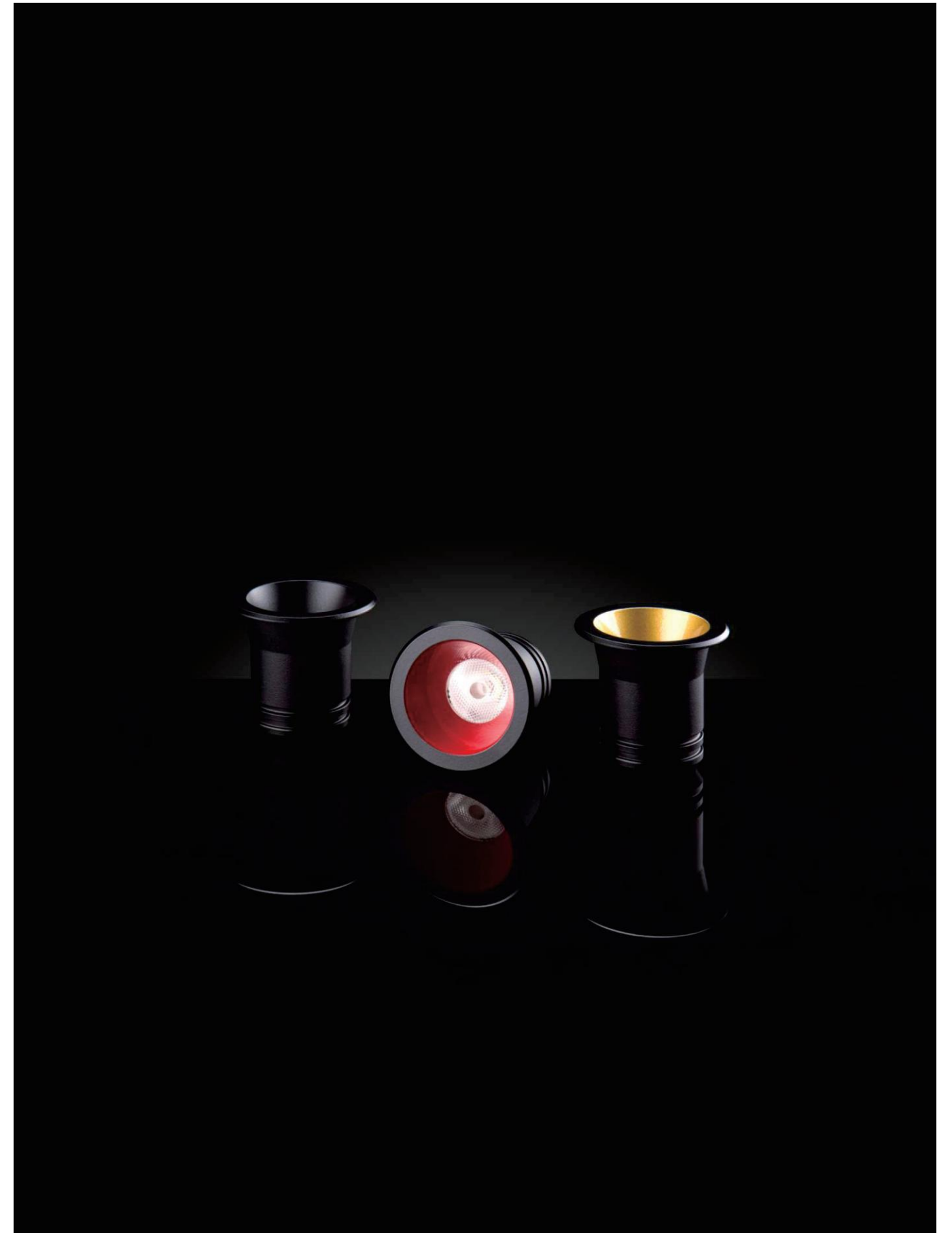

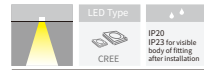

○ White as standard

## Ring

Power	CRI	Beam Angle	Luminous Flux	CCT	Housing	Model Number
2W	>80	30°	100lm	2700K	white	RING-W2700
			100lm	3000K	black	RING-B3000
			100lm	4000K	chrome	RING-C4000
			100lm	red	nickel	RING-NRED
			100lm	green	silver	RING-SGREEN
			100lm	blue	white	RING-WBLUE

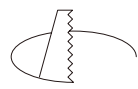
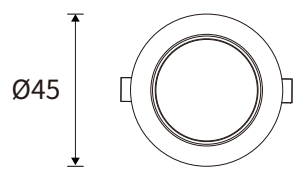
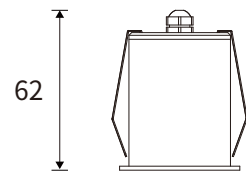

Ø40 mm

### LED & Driver

Osram:  
 Power: 2-3W/LED  
 Voltage: 3V  
 SDCM<5  
 Driver:  
 Input Voltage:220-240VAC  
 Output Current:500mA  
 Output Voltage:DC2.2-4.2V



G.W.:12.00kgs  
 Packaging:47x37x37cm,100PCS/CTN

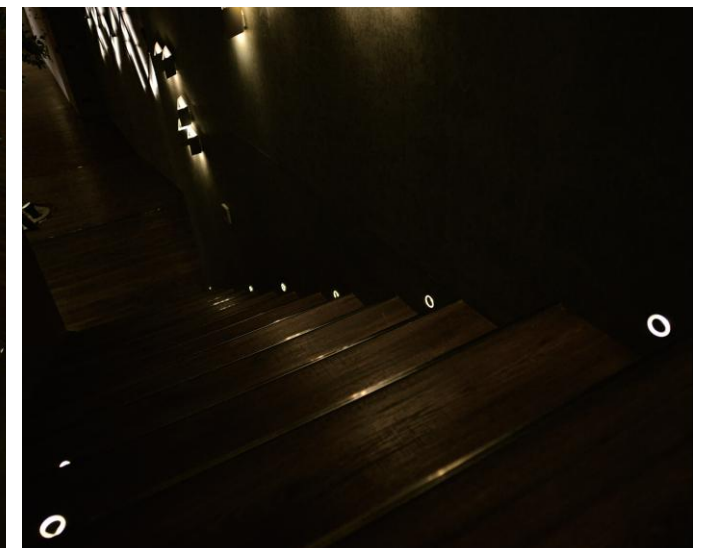
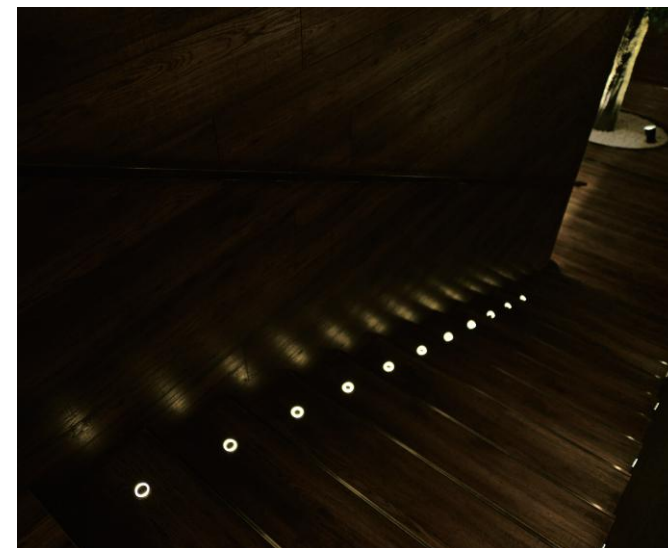

# Master





LED Type: CREE, IP20, IP23 for visible body of fitting after installation. White trim+grey heat sink as standard. **Master**

Power	CRI	Beam Angle	Luminous Flux	CCT	Refractive ring	Frame	Model Number
10W	>80	15°	900lm	2700K	white	white	MAS10-W2715
			900lm	3000K	black	white	MAS10-WB3015
			900lm	4000K	white	white	MAS10-W4015
		24°	900lm	2700K	black	white	MAS10-WB2724
			900lm	3000K	white	white	MAS10-W3024
			900lm	4000K	black	white	MAS10-WB4024
		36°	900lm	2700K	white	white	MAS10-W2736
			900lm	3000K	black	white	MAS10-WB3036
			900lm	4000K	white	white	MAS10-W4036

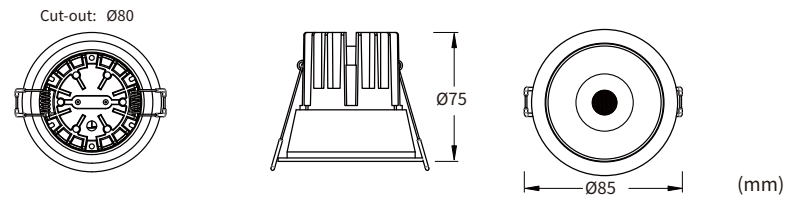
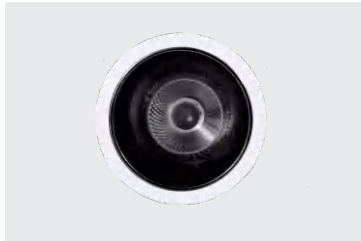

Accessory

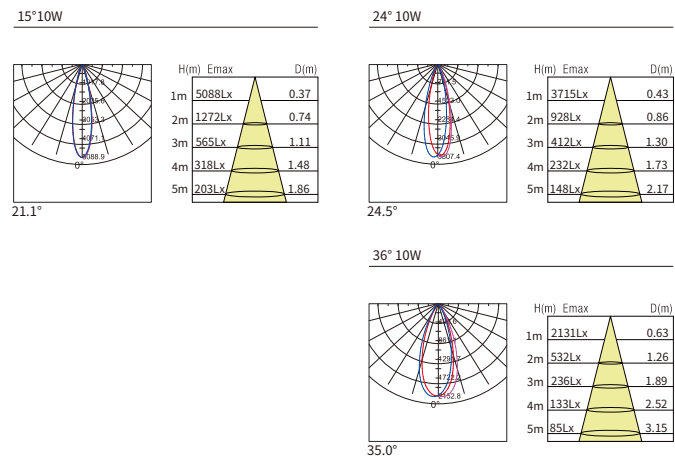
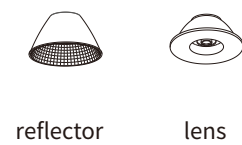

LED & Driver

CREE CXA1507  
 Power: 7-10W/LED  
 Voltage: 36V  
 SDCM<5  
 Driver:  
 Input Voltage:AC220-240VAC  
 Output Current:250mA  
 Output Voltage:DC28-40V



G.W.:13.50kgs  
 Packaging:56.5x56.5x25cm,50PCS/CTN



LED Type: CREE, IP20, IP23 for visible body of fitting after installation. White trim+grey heat sink as standard. **Master minimal**

Power	CRI	Beam Angle	Luminous Flux	CCT	Refractive ring	Frame	Model Number
10W	>80	15°	900lm	2700K	white	minimal	MAS10M-W2715
			900lm	3000K	white	minimal	MAS10M-W3015
			900lm	4000K	white	minimal	MAS10M-W4015
		24°	900lm	2700K	white	minimal	MAS10M-W2724
			900lm	3000K	white	minimal	MAS10M-W3024
			900lm	4000K	white	minimal	MAS10M-W4024
		36°	900lm	2700K	white	minimal	MAS10M-W2736
			900lm	3000K	white	minimal	MAS10M-W3036
			900lm	4000K	white	minimal	MAS10M-W4036

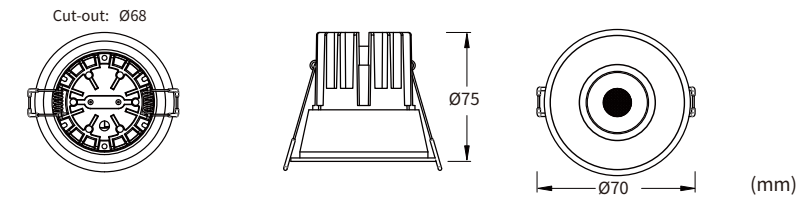

Accessory

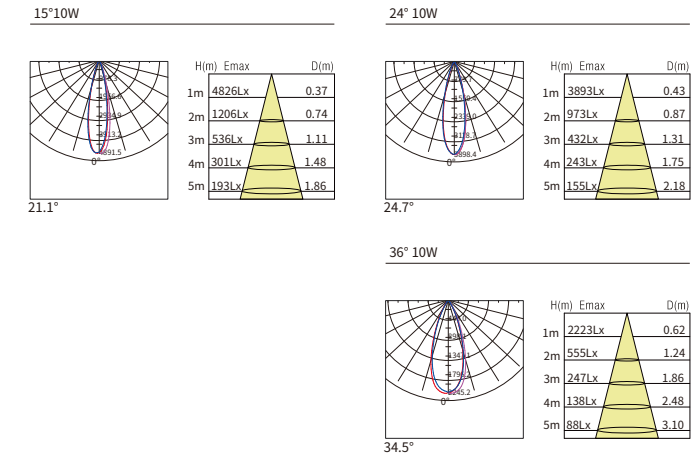
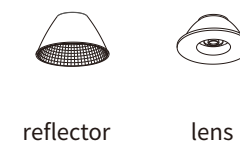

LED & Driver

CREE CXA1507  
 Power: 7-10W/LED  
 Voltage: 36V  
 SDCM<5  
 Driver:  
 Input Voltage:AC220-240VAC  
 Output Current:250mA  
 Output Voltage:DC28-40V



G.W.:13.50kgs  
 Packaging:56.5x56.5x25cm,50PCS/CTN





# Cooler

COOLER is using special smoke color reflector.

The sleek housing takes care of cooling, ensuring the best possible conditions for LED.

Available in round and square, surface mounted to the ceiling.

LED Type: CITIZEN IP20

○ White color as standard

Power	CRI	Beam Angle	Luminous Flux	CCT	Housing	Model Number
10W	>90	15°	900lm	2700K	white	COOLER10R-W2715
			960lm	3000K	white	COOLER10R-W3015
			1020lm	4000K	white	COOLER10R-W4015
		24°	900lm	2700K	white	COOLER10R-W2724
			960lm	3000K	white	COOLER10R-W3024
			1020lm	4000K	white	COOLER10R-W4024
		36°	900lm	2700K	white	COOLER10R-W2736
			960lm	3000K	white	COOLER10R-W3036
			1020lm	4000K	white	COOLER10R-W4036

## Cooler round

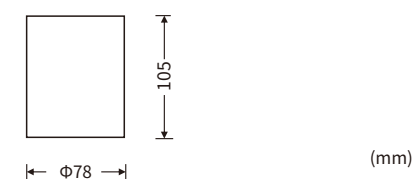

### LED & Driver

CITIZEN COB:  
 Power: 10W/LED  
 Voltage: 36V  
 SDCM<5  
 KEGU driver:  
 Input voltage:100-240VAC  
 /220-240V/110-130V  
 Output current:250mA  
 Output voltage:DC24-40V



15° 10W

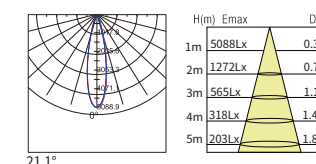

24° 10W

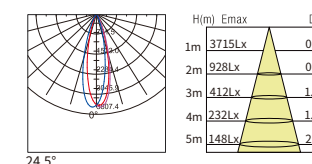

36° 10W

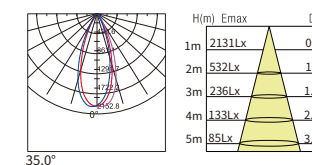

LED Type: CITIZEN IP20  White color as standard **Cooler round**

Power	CRI	Beam Angle	Luminous Flux	CCT	Housing	Model Number
15W	>90	15°	1350lm	2700K	white	COOLER15R-W2715
			1410lm	3000K	white	COOLER15R-W3015
			1470lm	4000K	white	COOLER15R-W4015
		24°	1350lm	2700K	white	COOLER15R-W2724
			1410lm	3000K	white	COOLER15R-W3024
			1470lm	4000K	white	COOLER15R-W4024
		36°	1350lm	2700K	white	COOLER15R-W2736
			1410lm	3000K	white	COOLER15R-W3036
			1470lm	4000K	white	COOLER15R-W4036

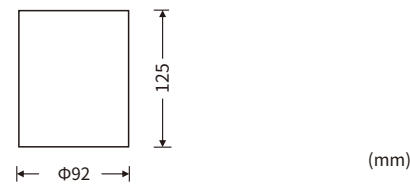

LED Type: CITIZEN IP20  White color as standard **Cooler round**

Power	CRI	Beam Angle	Luminous Flux	CCT	Housing	Model Number
30W	>90	15°	2700lm	2700K	white	COOLER30R-W2715
			2760lm	3000K	white	COOLER30R-W3015
			2820lm	4000K	white	COOLER30R-W4015
			2700lm	2700K	white	COOLER30R-W2724
		24°	2760lm	3000K	white	COOLER30R-W3024
			2820lm	4000K	white	COOLER30R-W4024
			2700lm	2700K	white	COOLER30R-W2736
			2760lm	3000K	white	COOLER30R-W3036
		36°	2820lm	4000K	white	COOLER30R-W4036

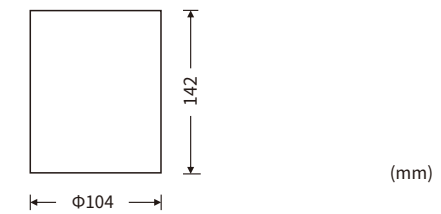

LED & Driver

CITIZEN COB:  
Power: 15W/LED  
Voltage: 36V  
SDCM<5  
KEGU driver:  
Input voltage:100-240VAC  
/220-240V/110-130V  
Output current:500mA  
Output voltage:DC24-45V

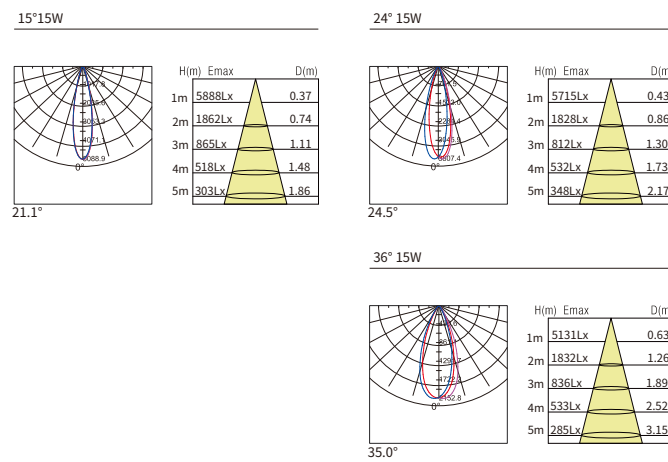

LED & Driver

CITIZEN COB:  
Power: 30W/LED  
Voltage: 36V  
SDCM<5  
KEGU driver:  
Input voltage:100-240VAC  
/220-240V/110-130V  
Output current:600mA  
Output voltage:DC30-50V

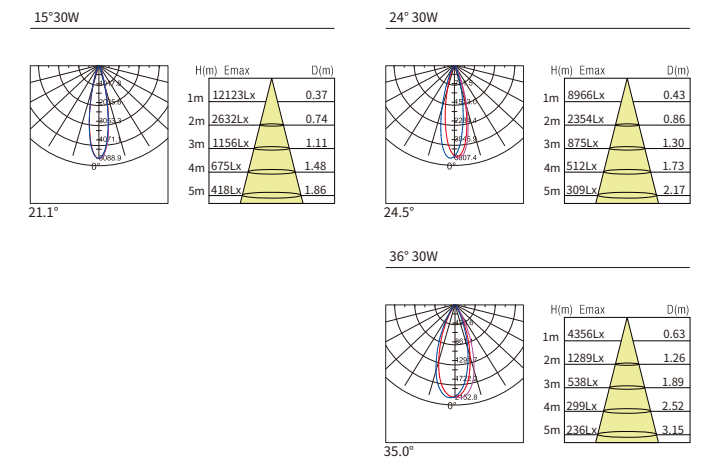



## Cooler square



LED Type: CITIZEN IP20  White color as standard

Power	CRI	Beam Angle	Luminous Flux	CCT	Housing	Model Number
10W	>90	15°	900lm	2700K	white	COOLER10S-W2715
			960lm	3000K	white	COOLER10S-W3015
			1020lm	4000K	white	COOLER10S-W4015
		30°	900lm	2700K	white	COOLER10S-W2724
			960lm	3000K	white	COOLER10S-W3024
			1020lm	4000K	white	COOLER10S-W4024
		45°	900lm	2700K	white	COOLER10S-W2736
			960lm	3000K	white	COOLER10S-W3036
			1020lm	4000K	white	COOLER10S-W4036

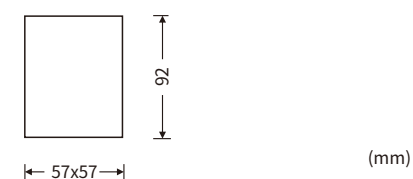

## Cooler square

COOLER is using special smoke color reflector.

The sleek housing takes care of cooling, ensuring the best possible conditions for LED.

Available in round and square, surface mounted to the ceiling.

### LED & Driver

CITIZEN COB:  
 Power: 10W/LED  
 Voltage: 36V  
 SDCM<5  
 KEGU driver:  
 Input voltage:100-240VAC  
 /220-240V/110-130V  
 Output current:250mA  
 Output voltage:DC24-40V



### 15° 10W

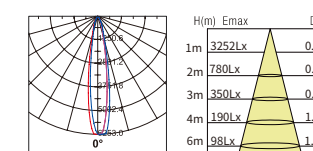

### 30° 10W

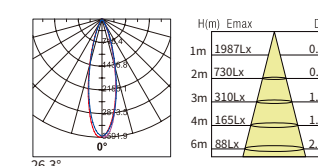

### 45° 10W

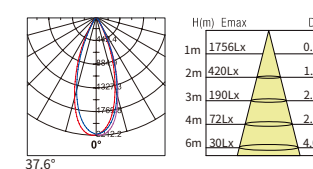

## Cooler square

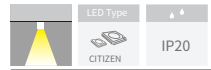

○ White color as standard

Power	CRI	Beam Angle	Luminous Flux	CCT	Housing	Model Number
15W	>90	15°	1350lm	2700K	white	COOLER15S-W2715
			1410lm	3000K	white	COOLER15S-W3015
			1470lm	4000K	white	COOLER15S-W4015
		30°	1350lm	2700K	white	COOLER15S-W2730
			1410lm	3000K	white	COOLER15S-W3030
			1470lm	4000K	white	COOLER15S-W4030
		45°	1350lm	2700K	white	COOLER15S-W2745
			1410lm	3000K	white	COOLER15S-W3045
			1470lm	4000K	white	COOLER15S-W4045

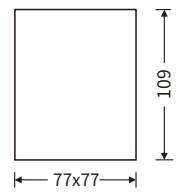

(mm)

### LED & Driver

CITIZEN COB:  
 Power: 15W/LED  
 Voltage: 36V  
 SDCM<5  
 KEGU driver:  
 Input voltage:100-240VAC  
 /220-240V/110-130V  
 Output current:500mA  
 Output voltage:DC24-45V



15° 15W

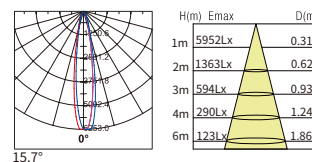

30° 15W

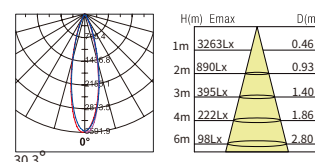

45° 15W

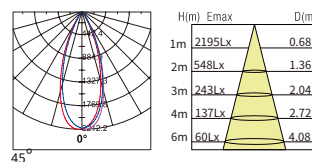

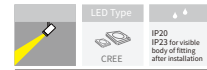

● Black as standard

## Mini

Power	CRI	Beam Angle	Luminous Flux	CCT	Housing	Type	Model Number
3W	>90	15°	210lm	2700K	black	recessed	MI03-B2715R
			210lm	3000K	black	surface	MI03-B3015SUR
			210lm	4000K	black	recessed	MI03-B4015R
		20°	210lm	2700K	black	surface	MI03-B2720SUR
			210lm	3000K	black	recessed	MI03-B3020R
			210lm	4000K	black	surface	MI03-B4020SUR
30°	210lm	2700K	black	recessed	MI03-B2730R		
	210lm	3000K	black	surface	MI03-B3030SUR		
	210lm	4000K	black	recessed	MI03-B4030R		

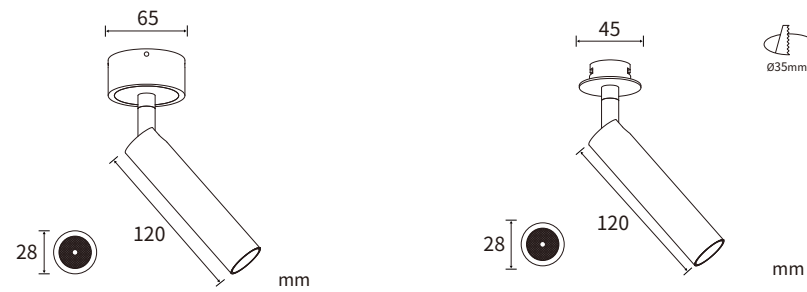

### Filter



### LED & Driver

OSRAM/CREE COB:  
 Power: 3W/LED  
 Voltage: 3V  
 SDCM<5  
 Driver:  
 Input Voltage:220-240VAC  
 Output Current:500mA  
 Output Voltage:DC2.2-4.2V





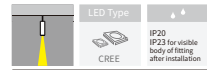

● Black as standard

## Mini

Power	CRI	Beam Angle	Luminous Flux	CCT	Housing	Type	Model Number
3W	>90	15°	210lm	2700K	black	recessed	MI20-B2715R
			210lm	3000K	black	surface	MI40-B3015SUR
			210lm	4000K	black	recessed	MI60-B4015R
		20°	210lm	2700K	black	surface	MI20-B2720SUR
			210lm	3000K	black	recessed	MI40-B3020R
			210lm	4000K	black	surface	MI60-B4020SUR
		30°	210lm	2700K	black	recessed	MI20-B2730R
			210lm	3000K	black	surface	MI40-B3030SUR
			210lm	4000K	black	recessed	MI60-B4030R

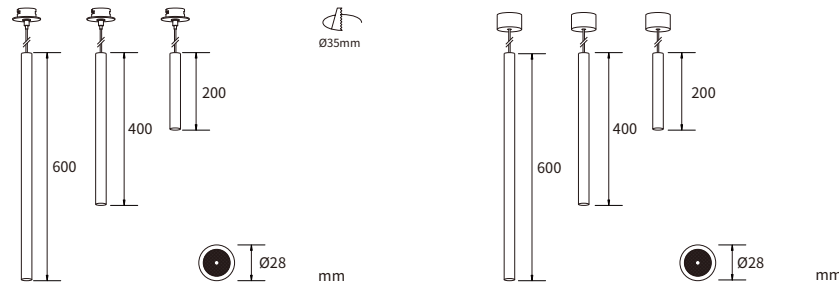

### LED & Driver

OSRAM/CREE COB:  
 Power: 3W/LED  
 Voltage: 3V  
 SDCM<5  
 Driver:  
 Input Voltage:220-240VAC  
 Output Current:500mA  
 Output Voltage:DC2.2-4.2V

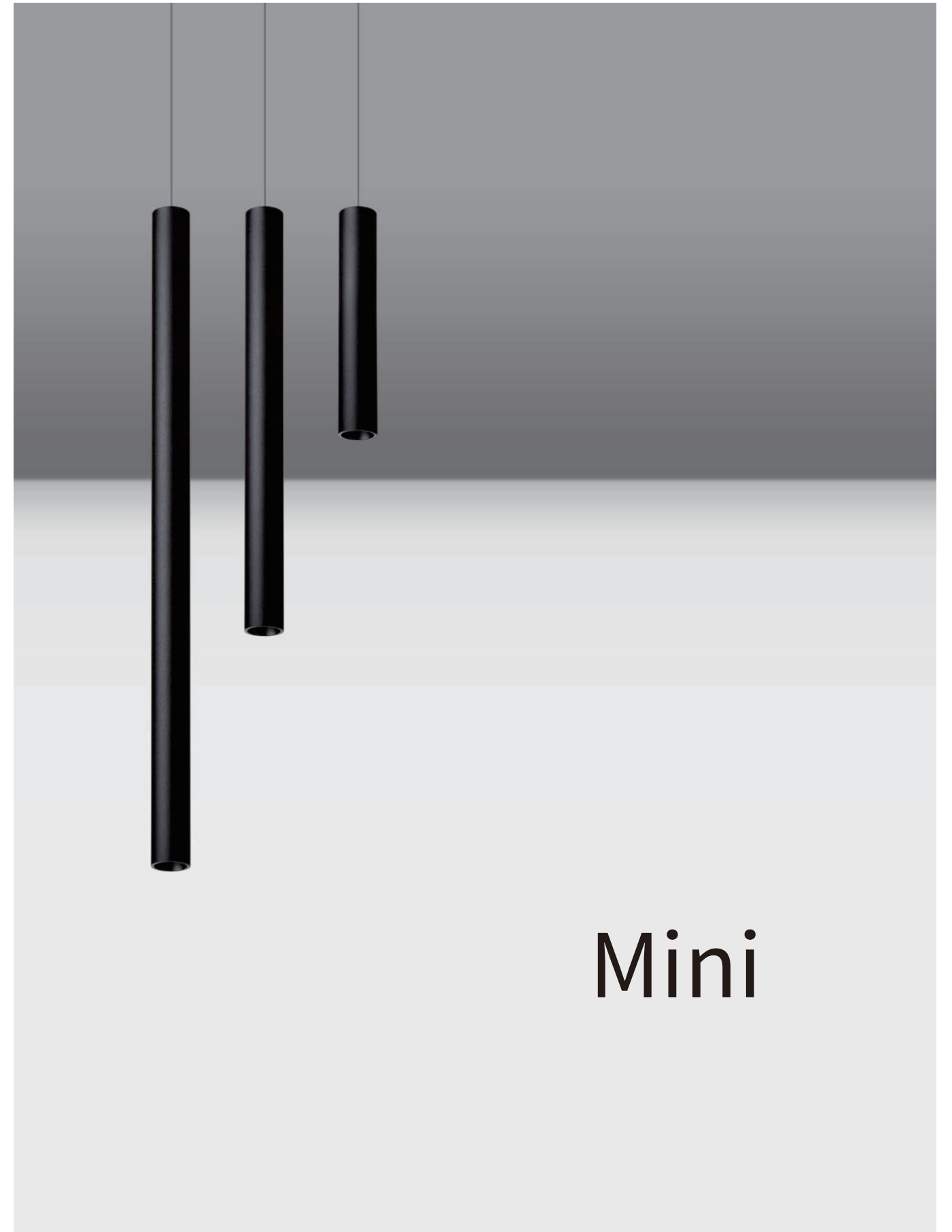

# Mini

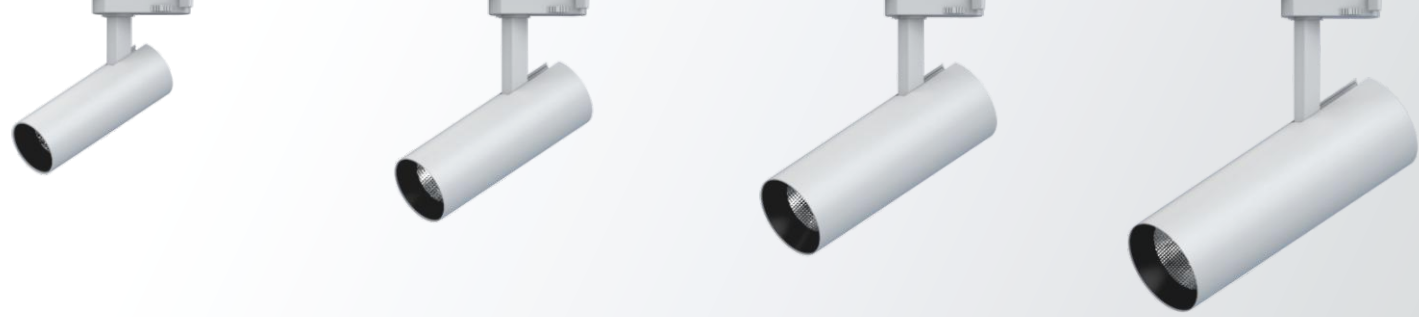

## Clean Track

LED Type: CREE IP20  
 ●○ Black or white as standard

Power	CRI	Beam Angle	Luminous Flux	CCT	Housing	Model Number
7W	>90	15°	630lm	2700K	white	CLET07R-W2715
			680lm	3000K	black	CLET07R-B3015
			720lm	4000K	black	CLET07R-B4015
		23°	630lm	2700K	black	CLET07R-B2723
			680lm	3000K	white	CLET07R-B3023
			720lm	4000K	black	CLET07R-B4023
		38°	630lm	2700K	black	CLET07R-B2738
			680lm	3000K	black	CLET07R-B3038
			720lm	4000K	white	CLET07R-W4038

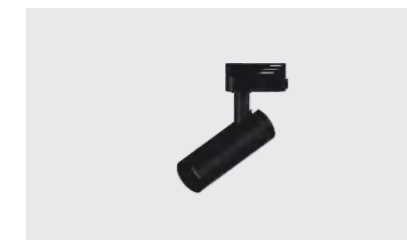

## Clean

Interior lighting spotlight with LED light source. Available in three versions: Mono Point version, support recessed/surface/suspension/track installation, consisting of a removable cylindrical housing which, in its upper position, acts as a downlight, and in its lower position, becomes a directional spotlight, Double Point version, consisting of a recessed box which houses two spotlights.

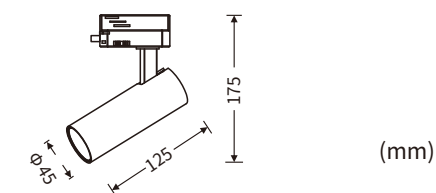

### Angle



### LED & Driver

CREE COB:  
 Power: 7W/LED  
 Voltage: 18V  
 SDCM<6  
 KEGU driver:  
 Input voltage:100-240VAC  
 /220-240V/110-130V  
 Output current:180mA  
 Output voltage:DC12-24V

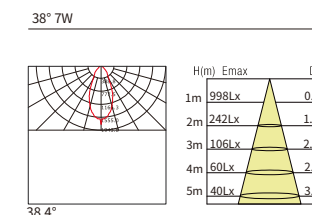



## Clean Track

LED Type: CREE IP20  
 ● ○ Black or white as standard

Power	CRI	Beam Angle	Luminous Flux	CCT	Frame	Model Number
30W	>90	15°	2700lm	2700K	white	CLET30R-W2715
			2760lm	3000K	black	CLET30R-B3015
			2820lm	4000K	white	CLET30R-W4015
		23°	2700lm	2700K	black	CLET30R-B2723
			2760lm	3000K	white	CLET30R-W3023
			2820lm	4000K	black	CLET30R-B4023
38°	2700lm	2700K	white	CLET30R-W2738		
	2760lm	3000K	black	CLET30R-B3038		
	2820lm	4000K	white	CLET30R-W4038		

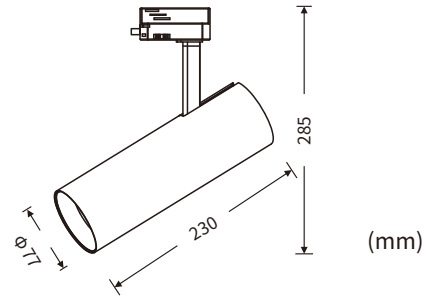

### Angle



### LED & Driver

CREE COB:  
 Power: 30W/LED  
 Voltage: 36V  
 SDCM<6  
 KEGU driver:  
 Input voltage:100-240VAC  
 /220-240V/110-130V  
 Output current:700mA  
 Output voltage:DC24-54V



38° 30W

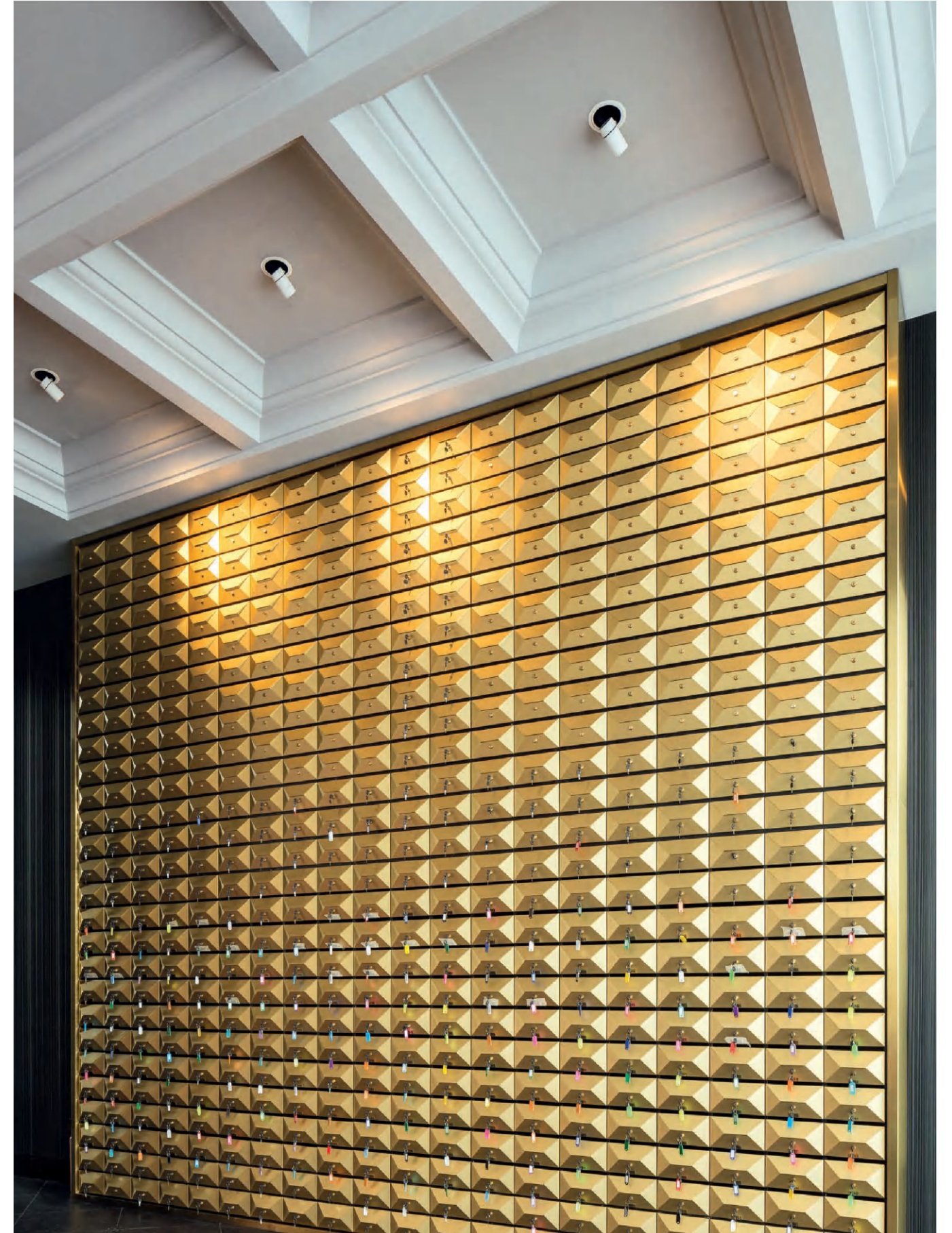
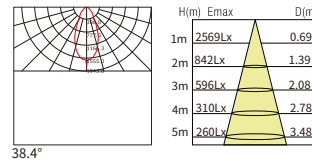



### Clean Track

LED Type: CREE IP20 ●○ Black or white as standard

Power	CRI	Beam Angle	Luminous Flux	CCT	Housing	Model Number
12W	>90	15°	1080lm	2700K	white	CLET12R-W2715
			1140lm	3000K	black	CLET12R-B3015
			1200lm	4000K	white	CLET12R-W4015
		23°	1080lm	2700K	black	CLET12R-B2723
			1140lm	3000K	white	CLET12R-W3023
			1200lm	4000K	black	CLET12R-B4023
		38°	1080lm	2700K	white	CLET12R-W2738
			1140lm	3000K	black	CLET12R-B3038
			1200lm	4000K	white	CLET12R-W4038

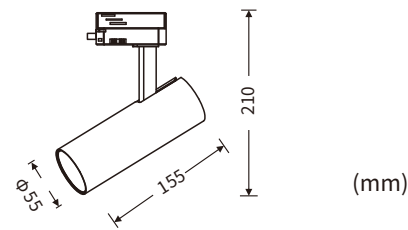

#### Angle



#### LED & Driver

CREE COB:  
 Power: 12W/LED  
 Voltage: 36V  
 SDCM<6  
 KEGU driver:  
 Input voltage:100-240VAC  
 /220-240V/110-130V  
 Output current:300mA  
 Output voltage:DC24-42V

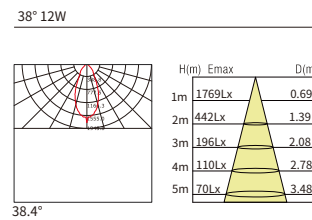

### Clean Track

LED Type: CREE IP20 ●○ Black or white as standard

Power	CRI	Beam Angle	Luminous Flux	CCT	Housing	Model Number
20W	>90	15°	1800lm	2700K	white	CLET20R-W2715
			1860lm	3000K	black	CLET20R-B3015
			1920lm	4000K	white	CLET20R-W4015
		23°	1800lm	2700K	black	CLET20R-B2723
			1860lm	3000K	white	CLET20R-W3023
			1920lm	4000K	black	CLET20R-B4023
		38°	1800lm	2700K	white	CLET20R-W2738
			1860lm	3000K	black	CLET20R-B3038
			1920lm	4000K	white	CLET20R-W4038

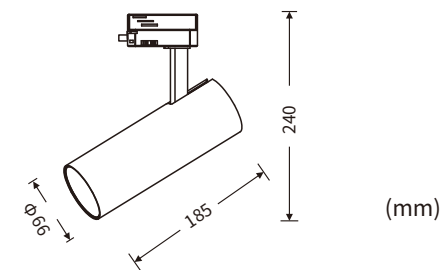

#### Angle



#### LED & Driver

CREE COB:  
 Power: 20W/LED  
 Voltage: 36V  
 SDCM<6  
 KEGU driver:  
 Input voltage:100-240VAC  
 /220-240V/110-130V  
 Output current:600mA  
 Output voltage:DC24-45V

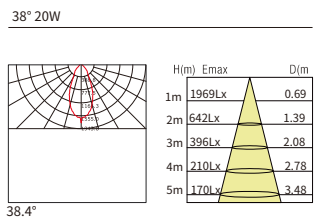

LED Type: CREE IP20 ●○ Black or white as standard **Clean Recessed**

Power	CRI	Beam Angle	Luminous Flux	CCT	Housing	Model Number
7W	>90	15°	630lm	2700K	white	CLER07R-W2715
			680lm	3000K	black	CLER07R-B3015
			720lm	4000K	black	CLER07R-B4015
		23°	630lm	2700K	black	CLER07R-B2723
			680lm	3000K	white	CLER07R-B3023
			720lm	4000K	black	CLER07R-B4023
		38°	630lm	2700K	black	CLER07R-B2738
			680lm	3000K	black	CLER07R-B3038
			720lm	4000K	white	CLER07R-W4038

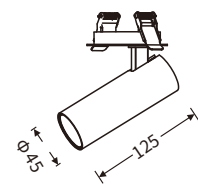
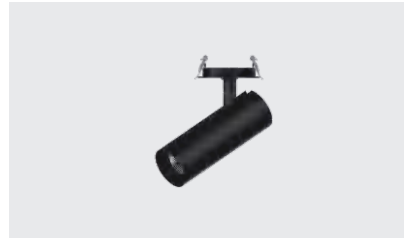

(mm)

cut out:Φ78

Angle



LED & Driver

CREE COB:  
Power: 7W/LED  
Voltage: 18V  
SDCM<6  
KEGU driver:  
Input voltage:100-240VAC  
/220-240V/110-130V  
Output current:180mA  
Output voltage:DC12-24V



38° 7W

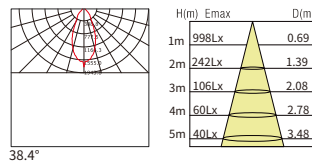

38.4°



LED Type: CREE IP20 ●○ Black or white as standard **Clean Recessed**

Power	CRI	Beam Angle	Luminous Flux	CCT	Housing	Model Number
12W	>90	15°	1080lm	2700K	white	CLER12R-W2715
			1140lm	3000K	black	CLER12R-B3015
			1200lm	4000K	white	CLER12R-W4015
		23°	1080lm	2700K	black	CLER12R-B2723
			1140lm	3000K	white	CLER12R-W3023
			1200lm	4000K	black	CLER12R-B4023
		38°	1080lm	2700K	white	CLER12R-W2738
			1140lm	3000K	black	CLER12R-B3038
			1200lm	4000K	white	CLER12R-W4038

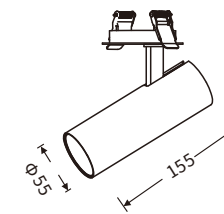
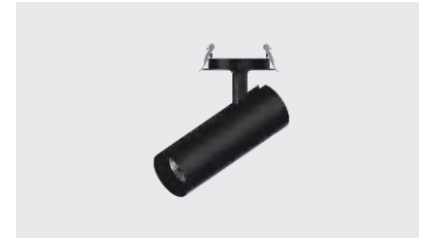

(mm)

cut out:Φ78

Angle



LED & Driver

CREE COB:  
Power: 12W/LED  
Voltage: 36V  
SDCM<6  
KEGU driver:  
Input voltage:100-240VAC  
/220-240V/110-130V  
Output current:300mA  
Output voltage:DC24-42V



38° 12W

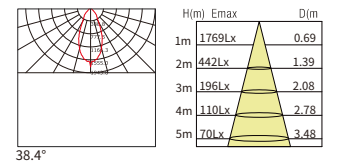

38.4°



LED Type: CREE IP20 ●○ Black or white as standard

Power	CRI	Beam Angle	Luminous Flux	CCT	Housing	Model Number
20W	>90	15°	1800lm	2700K	white	CLER20R-W2715
			1860lm	3000K	black	CLER20R-B3015
			1920lm	4000K	white	CLER20R-W4015
		23°	1800lm	2700K	black	CLER20R-B2723
			1860lm	3000K	white	CLER20R-W3023
			1920lm	4000K	black	CLER20R-B4023
		38°	1800lm	2700K	white	CLER20R-W2738
			1860lm	3000K	black	CLER20R-B3038
			1920lm	4000K	white	CLER20R-W4038

### Clean Recessed

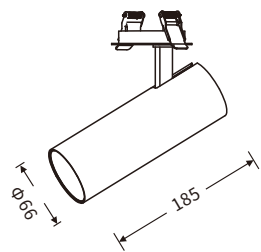

(mm)

cut out:Φ88

### Angle



### LED & Driver

CREE COB:  
Power: 20W/LED  
Voltage: 36V  
SDCM<6  
KEGU driver:  
Input voltage:100-240VAC  
/220-240V/110-130V  
Output current:600mA  
Output voltage:DC24-45V



38° 20W

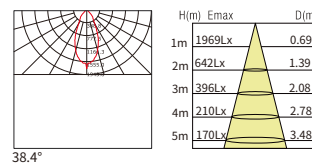

38.4°



LED Type: CREE IP20 ●○ Black or white as standard

Power	CRI	Beam Angle	Luminous Flux	CCT	Housing	Model Number
30W	>90	15°	2700lm	2700K	white	CLER30R-W2715
			2760lm	3000K	black	CLER30R-B3015
			2820lm	4000K	white	CLER30R-W4015
		23°	2700lm	2700K	black	CLER30R-B2723
			2760lm	3000K	white	CLER30R-W3023
			2820lm	4000K	black	CLER30R-B4023
		38°	2700lm	2700K	white	CLER30R-W2738
			2760lm	3000K	black	CLER30R-B3038
			2820lm	4000K	white	CLER30R-W4038

### Clean Recessed

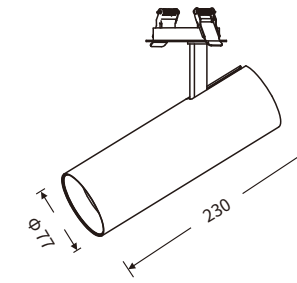

(mm)

cut out:Φ98

### Angle



### LED & Driver

CREE COB:  
Power: 30W/LED  
Voltage: 36V  
SDCM<6  
KEGU driver:  
Input voltage:100-240VAC  
/220-240V/110-130V  
Output current:700mA  
Output voltage:DC24-54V



38° 30W

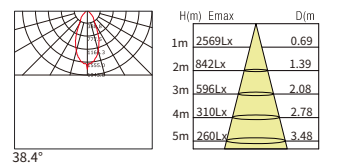

38.4°







## Clean Ceiling

LED Type: CREE IP20 ●○ Black or white as standard

Power	CRI	Beam Angle	Luminous Flux	CCT	Housing	Model Number
7W	>90	15°	630lm	2700K	white	CLEC07R-W2715
			680lm	3000K	black	CLEC07R-B3015
			720lm	4000K	black	CLEC07R-B4015
7W	>90	23°	630lm	2700K	black	CLEC07R-B2723
			680lm	3000K	white	CLEC07R-W3023
			720lm	4000K	black	CLEC07R-B4023
7W	>90	38°	630lm	2700K	black	CLEC07R-B2738
			680lm	3000K	black	CLEC07R-B3038
			720lm	4000K	white	CLEC07R-W4038

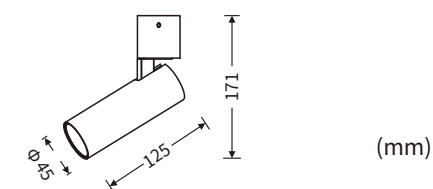

### Angle



### LED & Driver

CREE COB:  
 Power: 7W/LED  
 Voltage: 18V  
 SDCM<6  
 KEGU driver:  
 Input voltage:100-240VAC  
 /220-240V/110-130V  
 Output current:180mA  
 Output voltage:DC12-24V

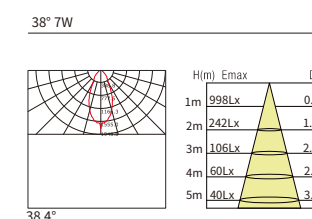

LED Type: CREE IP20 ●○ Black or white as standard

Power	CRI	Beam Angle	Luminous Flux	CCT	Frame	Model Number
12W	>90	15°	1080lm	2700K	white	CLEC12R-W2715
			1140lm	3000K	black	CLEC12R-B3015
			1200lm	4000K	white	CLEC12R-W4015
		23°	1080lm	2700K	black	CLEC12R-B2723
			1140lm	3000K	white	CLEC12R-W3023
			1200lm	4000K	black	CLEC12R-B4023
		38°	1080lm	2700K	white	CLEC12R-W2738
			1140lm	3000K	black	CLEC12R-B3038
			1200lm	4000K	white	CLEC12R-W4038

### Clean Ceiling

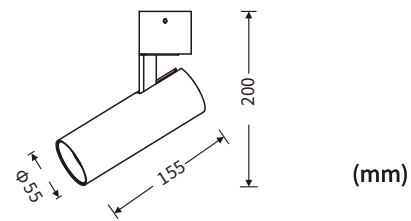

### Angle



### LED & Driver

CREE COB:  
 Power: 12W/LED  
 Voltage: 36V  
 SDCM<6  
 KEGU driver:  
 Input voltage:100-240VAC  
 /220-240V/110-130V  
 Output current:300mA  
 Output voltage:DC24-42V

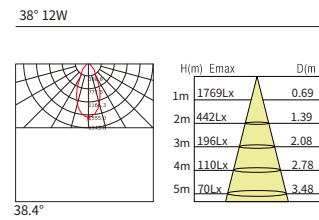

LED Type: CREE IP20 ●○ Black or white as standard

Power	CRI	Beam Angle	Luminous Flux	CCT	Housing	Model Number
20W	>90	15°	1800lm	2700K	white	CLEC20R-W2715
			1860lm	3000K	black	CLEC20R-B3015
			1920lm	4000K	white	CLEC20R-W4015
			1920lm	4000K	black	CLEC20R-B4023
		23°	1800lm	2700K	black	CLEC20R-B2723
			1860lm	3000K	white	CLEC20R-W3023
			1920lm	4000K	black	CLEC20R-B4023
			1920lm	4000K	white	CLEC20R-W4038
		38°	1800lm	2700K	white	CLEC20R-W2738
			1860lm	3000K	black	CLEC20R-B3038
			1860lm	3000K	black	CLEC20R-B3038
			1920lm	4000K	white	CLEC20R-W4038

### Clean Ceiling

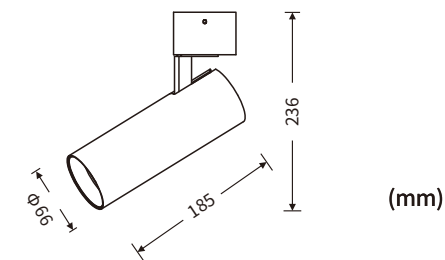

### Angle



### LED & Driver

CREE COB:  
 Power: 20W/LED  
 Voltage: 36V  
 SDCM<6  
 KEGU driver:  
 Input voltage:100-240VAC  
 /220-240V/110-130V  
 Output current:600mA  
 Output voltage:DC24-45V

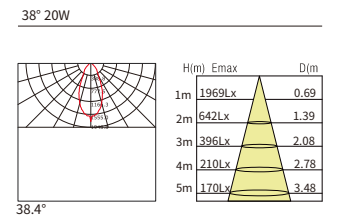



## Clean Ceiling

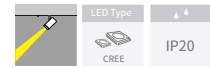

● ○ Black or white as standard

Power	CRI	Beam Angle	Luminous Flux	CCT	Frame	Model Number
30W	>90	15°	2700lm	2700K	white	CLEC30R-W2715
			2760lm	3000K	black	CLEC30R-B3015
			2820lm	4000K	white	CLEC30R-W4015
		23°	2700lm	2700K	black	CLEC30R-B2723
			2760lm	3000K	white	CLEC30R-W3023
			2820lm	4000K	black	CLEC30R-B4023
38°	2700lm	2700K	white	CLEC30R-W2738		
	2760lm	3000K	black	CLEC30R-B3038		
	2820lm	4000K	white	CLEC30R-W4038		

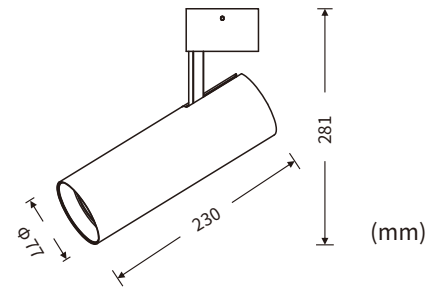

### Angle



### LED & Driver

CREE COB:  
 Power: 30W/LED  
 Voltage: 36V  
 SDCM<6  
 KEGU driver:  
 Input voltage:100-240VAC  
 /220-240V/110-130V  
 Output current:700mA  
 Output voltage:DC24-54V



38° 30W

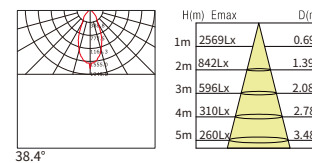



LED Type: CREE IP20 ●○ Black or white as standard **Clean Surface**

Power	CRI	Beam Angle	Luminous Flux	CCT	Housing	Model Number
7W	>90	15°	630lm	2700K	white	CLES07R-W2715
			680lm	3000K	black	CLES07R-B3015
			720lm	4000K	black	CLES07R-B4015
		23°	630lm	2700K	black	CLES07R-B2723
			680lm	3000K	white	CLES07R-W3023
			720lm	4000K	black	CLES07R-B4023
38°	630lm	2700K	black	CLES07R-B2738		
	680lm	3000K	black	CLES07R-B3038		
	720lm	4000K	white	CLES07R-W4038		

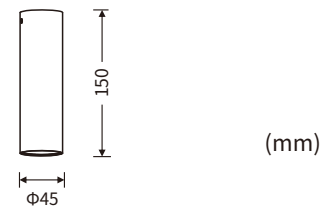

LED & Driver

CREE COB:  
 Power: 7W/LED  
 Voltage: 18V  
 SDCM<6  
 KEGU driver:  
 Input voltage:100-240VAC  
 /220-240V/110-130V  
 Output current:180mA  
 Output voltage:DC12-24V

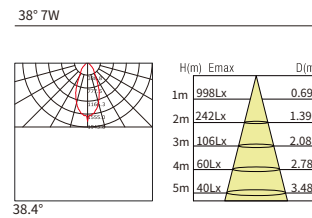

LED Type: CREE IP20 ●○ Black or white as standard **Clean Surface**

Power	CRI	Beam Angle	Luminous Flux	CCT	Housing	Model Number
12W	>90	15°	1080lm	2700K	white	CLES12R-W2715
			1140lm	3000K	black	CLES12R-B3015
			1200lm	4000K	white	CLES12R-W4015
		23°	1080lm	2700K	black	CLES12R-B2723
			1140lm	3000K	white	CLES12R-W3023
			1200lm	4000K	black	CLES12R-B4023
38°	1080lm	2700K	white	CLES12R-W2738		
	1140lm	3000K	black	CLES12R-B3038		
	1200lm	4000K	white	CLES12R-W4038		

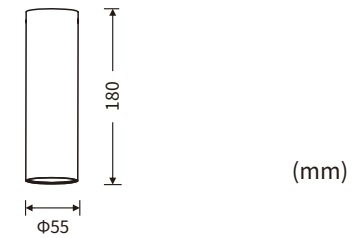

LED & Driver

CREE COB:  
 Power: 12W/LED  
 Voltage: 36V  
 SDCM<6  
 KEGU driver:  
 Input voltage:100-240VAC  
 /220-240V/110-130V  
 Output current:300mA  
 Output voltage:DC24-42V

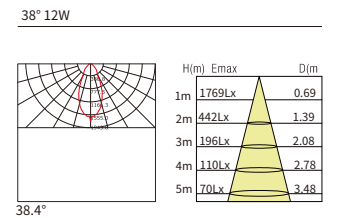

LED Type: CREE IP20 ●○ Black or white as standard **Clean Surface**

Power	CRI	Beam Angle	Luminous Flux	CCT	Housing	Model Number
20W	>90	15°	1800lm	2700K	white	CLES20R-W2715
			1860lm	3000K	black	CLES20R-B3015
			1920lm	4000K	white	CLES20R-W4015
		23°	1800lm	2700K	black	CLES20R-B2723
			1860lm	3000K	white	CLES20R-W3023
			1920lm	4000K	black	CLES20R-B4023
		38°	1800lm	2700K	white	CLES20R-W2738
			1860lm	3000K	black	CLES20R-B3038
			1920lm	4000K	white	CLES20R-W4038

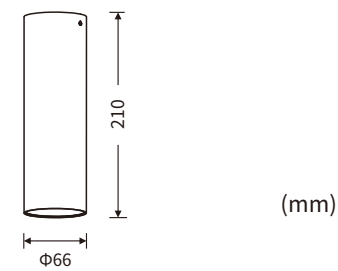

LED & Driver

CREE COB:  
 Power: 20W/LED  
 Voltage: 36V  
 SDCM<6  
 KEGU driver:  
 Input voltage:100-240VAC  
 /220-240V/110-130V  
 Output current:600mA  
 Output voltage:DC24-45V



38° 20W

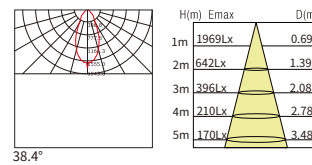

LED Type: CREE IP20 ●○ Black or white as standard **Clean Surface**

Power	CRI	Beam Angle	Luminous Flux	CCT	Housing	Model Number
30W	>90	15°	2700lm	2700K	white	CLES30R-W2715
			2760lm	3000K	black	CLES30R-B3015
			2820lm	4000K	white	CLES30R-W4015
			2700lm	2700K	black	CLES30R-B2723
		23°	2700lm	2700K	black	CLES30R-B2723
			2760lm	3000K	white	CLES30R-W3023
			2820lm	4000K	black	CLES30R-B4023
			2700lm	2700K	white	CLES30R-W2738
		38°	2700lm	2700K	white	CLES30R-W2738
			2760lm	3000K	black	CLES30R-B3038
			2820lm	4000K	white	CLES30R-W4038

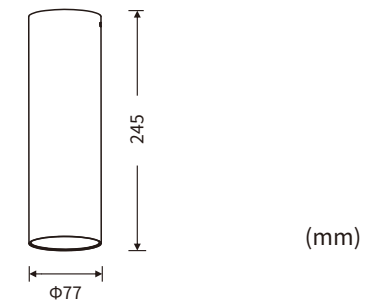

LED & Driver

CREE COB:  
 Power: 30W/LED  
 Voltage: 36V  
 SDCM<6  
 KEGU driver:  
 Input voltage:100-240VAC  
 /220-240V/110-130V  
 Output current:700mA  
 Output voltage:DC24-54V



38° 30W

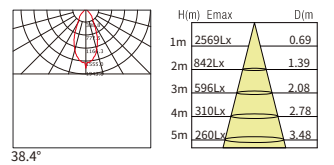





LED Type: CREE IP20 ●○ Black or white as standard

Power	CRI	Beam Angle	Luminous Flux	CCT	Housing	Model Number
7W	>90	15°	630lm	2700K	white	CLESU07R-W2715
			680lm	3000K	black	CLESU07R-B3015
			720lm	4000K	black	CLESU07R-B4015
		23°	630lm	2700K	black	CLESU07R-B2723
			680lm	3000K	white	CLESU07R-W3023
			720lm	4000K	black	CLESU07R-B4023
		38°	630lm	2700K	black	CLESU07R-B2738
			680lm	3000K	black	CLESU07R-B3038
			720lm	4000K	white	CLESU07R-W4038

### Clean Suspended

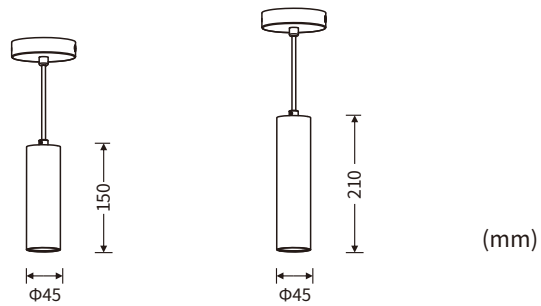
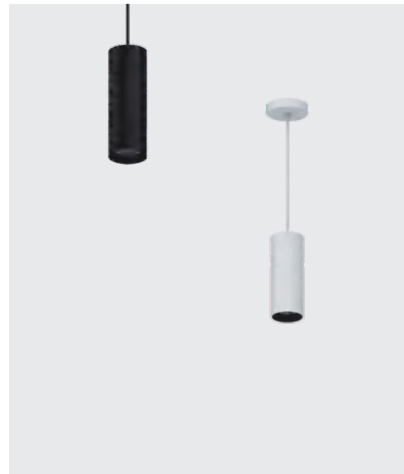

#### LED & Driver

CREE COB:  
 Power: 7W/LED  
 Voltage: 18V  
 SDCM<6  
 KEGU driver:  
 Input voltage:100-240VAC  
 /220-240V/110-130V  
 Output current:180mA  
 Output voltage:DC12-24V



38° 7W

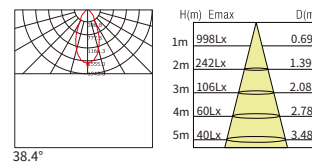

LED Type: CREE IP20 ●○ Black or white as standard

Power	CRI	Beam Angle	Luminous Flux	CCT	Housing	Model Number
12W	>90	15°	1080lm	2700K	white	CLESU12R-W2715
			1140lm	3000K	black	CLESU12R-B3015
			1200lm	4000K	white	CLESU12R-W4015
		23°	1080lm	2700K	black	CLESU12R-B2723
			1140lm	3000K	white	CLESU12R-W3023
			1200lm	4000K	black	CLESU12R-B4023
		38°	1080lm	2700K	white	CLESU12R-W2738
			1140lm	3000K	black	CLESU12R-B3038
			1200lm	4000K	white	CLESU12R-W4038

### Clean Suspended

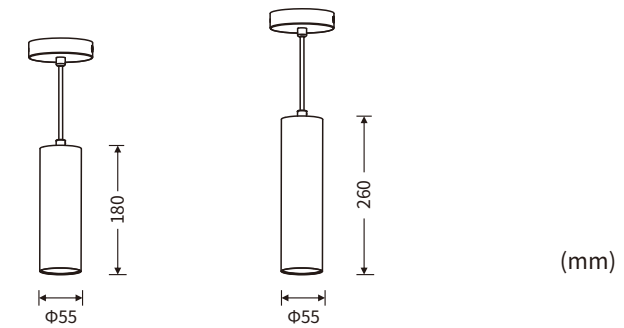

#### LED & Driver

CREE COB:  
 Power: 12W/LED  
 Voltage: 36V  
 SDCM<6  
 KEGU driver:  
 Input voltage:100-240VAC  
 /220-240V/110-130V  
 Output current:300mA  
 Output voltage:DC24-42V



38° 12W

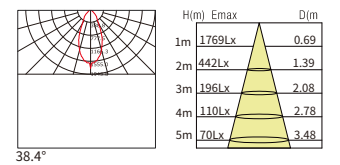

LED Type: CREE IP20 ●○ Black or white as standard

Power	CRI	Beam Angle	Luminous Flux	CCT	Housing	Model Number
20W	>90	15°	1800lm	2700K	white	CLESU20R-W2715
			1860lm	3000K	black	CLESU20R-B3015
			1920lm	4000K	white	CLESU20R-W4015
		23°	1800lm	2700K	black	CLESU20R-B2723
			1860lm	3000K	white	CLESU20R-W3023
			1920lm	4000K	black	CLESU20R-B4023
		38°	1800lm	2700K	white	CLESU20R-W2738
			1860lm	3000K	black	CLESU20R-B3038
			1920lm	4000K	white	CLESU20R-W4038

### Clean Suspended

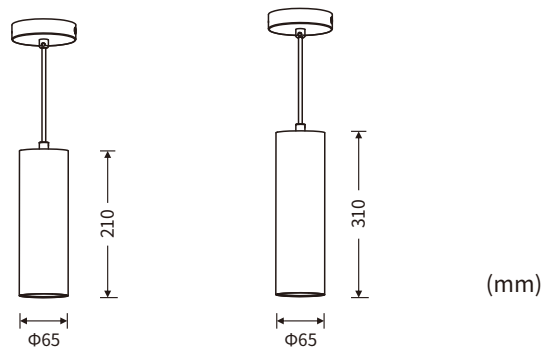

#### LED & Driver

CREE COB:  
Power: 20W/LED  
Voltage: 36V  
SDCM<6  
KEGU driver:  
Input voltage:100-240VAC  
/220-240V/110-130V  
Output current:600mA  
Output voltage:DC24-45V



38° 20W

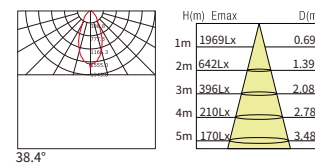

LED Type: CREE IP20 ●○ Black or white as standard

Power	CRI	Beam Angle	Luminous Flux	CCT	Housing	Model Number
30W	>90	15°	2700lm	2700K	white	CLESU30R-W2715
			2760lm	3000K	black	CLESU30R-B3015
			2820lm	4000K	white	CLESU30R-W4015
		23°	2700lm	2700K	black	CLESU30R-B2723
			2760lm	3000K	white	CLESU30R-W3023
			2820lm	4000K	black	CLESU30R-B4023
		38°	2700lm	2700K	white	CLESU30R-W2738
			2760lm	3000K	black	CLESU30R-B3038
			2820lm	4000K	white	CLESU30R-W4038

### Clean Suspended

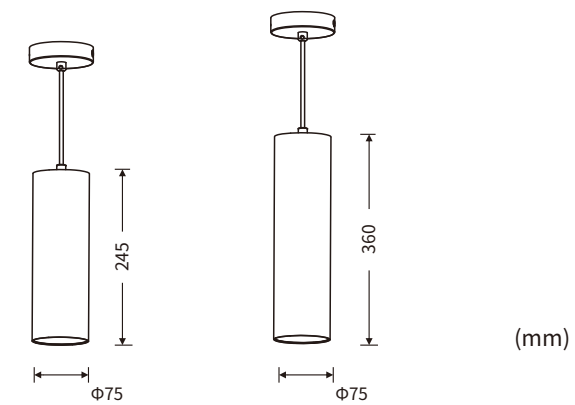

#### LED & Driver

CREE COB:  
Power: 30W/LED  
Voltage: 36V  
SDCM<6  
KEGU driver:  
Input voltage:100-240VAC  
/220-240V/110-130V  
Output current:700mA  
Output voltage:DC24-54V



38° 30W

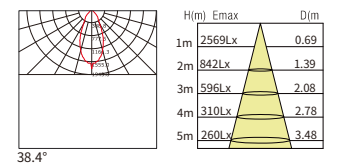



## Clean square

It is hip to be square.

Square track light is available in sizes Mini(45mm), Small (55mm), Medium (65mm) and Large (75mm) with lumen packages of 560, 960, 1600 and 2400 lumens. The arm of the trackspots provides 355°rotation and 90°tilt.

## Clean Track

LED Type: CREE IP20 ●○ Black or white as standard

Power	CRI	Beam Angle	Luminous Flux	CCT	Housing	Model Number
7W	>90	15°	630lm	2700K	white	CLET07S-W2715
			680lm	3000K	black	CLET07S-B3015
			720lm	4000K	black	CLET07S-B4015
		23°	630lm	2700K	black	CLET07S-B2723
			680lm	3000K	white	CLET07S-B3023
			720lm	4000K	black	CLET07S-B4023
38°	630lm	2700K	black	CLET07S-B2738		
	680lm	3000K	black	CLET07S-B3038		
	720lm	4000K	white	CLET07S-W4038		

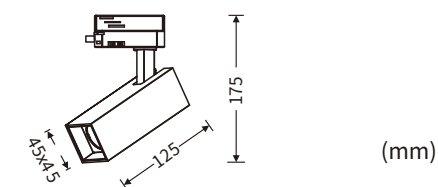

### Angle



### LED & Driver

CREE COB:  
 Power: 7W/LED  
 Voltage: 18V  
 SDCM<6  
 KEGU driver:  
 Input voltage:100-240VAC  
 /220-240V/110-130V  
 Output current:180mA  
 Output voltage:DC12-24V

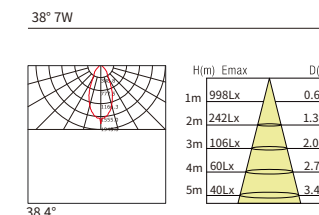



Clean Track

LED Type: CREE IP20 ●○ Black or white as standard

Power	CRI	Beam Angle	Luminous Flux	CCT	Frame	Model Number
12W	>90	15°	1080lm	2700K	white	CLET12S-W2715
			1140lm	3000K	black	CLET12S-B3015
			1200lm	4000K	white	CLET12S-W4015
		23°	1080lm	2700K	black	CLET12S-B2723
			1140lm	3000K	white	CLET12S-W3023
			1200lm	4000K	black	CLET12S-B4023
		38°	1080lm	2700K	white	CLET12S-W2738
			1140lm	3000K	black	CLET12S-B3038
			1200lm	4000K	white	CLET12S-W4038

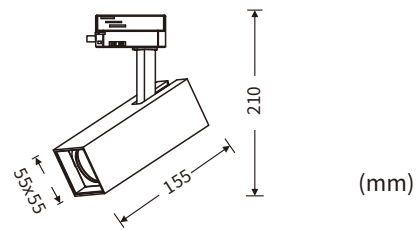

Angle



LED & Driver

CREE COB:  
 Power: 12W/LED  
 Voltage: 36V  
 SDCM<6  
 KEGU driver:  
 Input voltage:100-240VAC  
 /220-240V/110-130V  
 Output current:300mA  
 Output voltage:DC24-42V



38° 12W

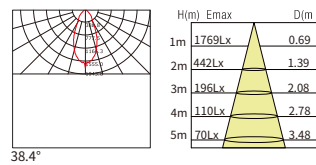

Clean Track

LED Type: CREE IP20 ●○ Black or white as standard

Power	CRI	Beam Angle	Luminous Flux	CCT	Housing	Model Number
20W	>90	15°	1800lm	2700K	white	CLET20S-W2715
			1860lm	3000K	black	CLET20S-B3015
			1920lm	4000K	white	CLET20S-W4015
		23°	1800lm	2700K	black	CLET20S-B2723
			1860lm	3000K	white	CLET20S-W3023
			1920lm	4000K	black	CLET20S-B4023
		38°	1800lm	2700K	white	CLET20S-W2738
			1860lm	3000K	black	CLET20S-B3038
			1920lm	4000K	white	CLET20S-W4038

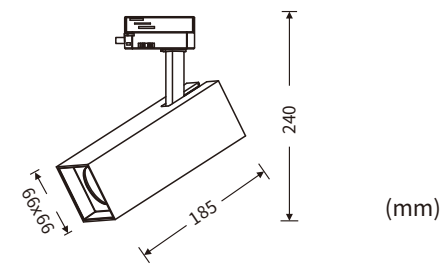

Angle



LED & Driver

CREE COB:  
 Power: 20W/LED  
 Voltage: 36V  
 SDCM<6  
 KEGU driver:  
 Input voltage:100-240VAC  
 /220-240V/110-130V  
 Output current:600mA  
 Output voltage:DC24-45V



38° 20W

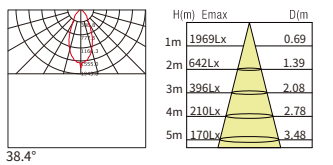

## Clean Track

LED Type: CREE IP20  
 ●○ Black or white as standard

Power	CRI	Beam Angle	Luminous Flux	CCT	Frame	Model Number
30W	>90	15°	2700lm	2700K	white	CLET30S-W2715
			2760lm	3000K	black	CLET30S-B3015
			2820lm	4000K	white	CLET30S-W4015
		23°	2700lm	2700K	black	CLET30S-B2723
			2760lm	3000K	white	CLET30S-W3023
			2820lm	4000K	black	CLET30S-B4023
38°	2700lm	2700K	white	CLET30S-W2738		
	2760lm	3000K	black	CLET30S-B3038		
	2820lm	4000K	white	CLET30S-W4038		

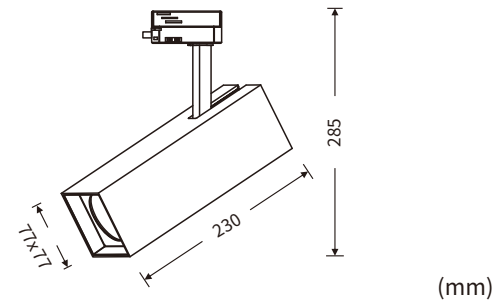

### Angle



### LED & Driver

CREE COB:  
 Power: 30W/LED  
 Voltage: 36V  
 SDCM<6  
 KEGU driver:  
 Input voltage:100-240VAC  
 /220-240V/110-130V  
 Output current:700mA  
 Output voltage:DC24-54V



38° 30W

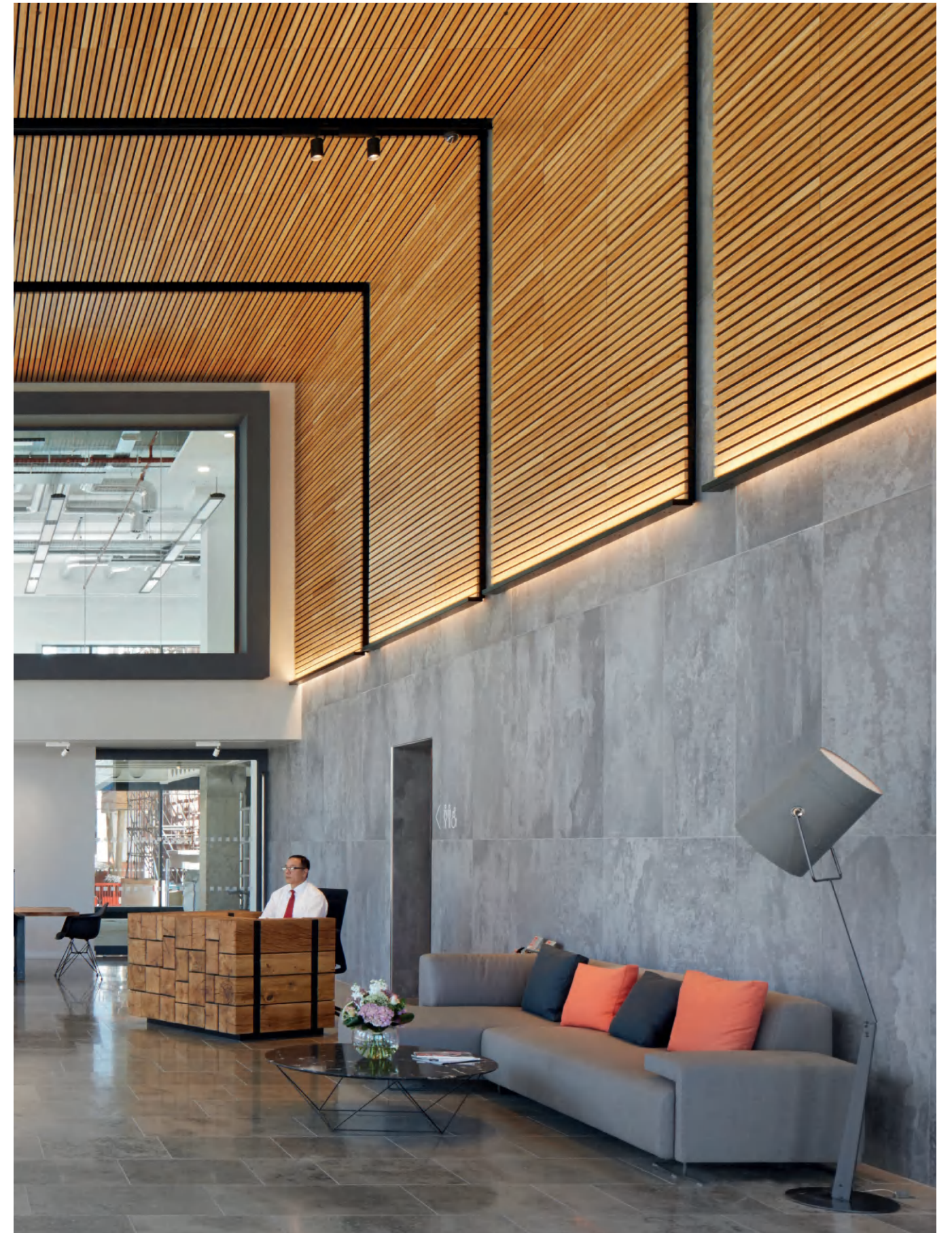
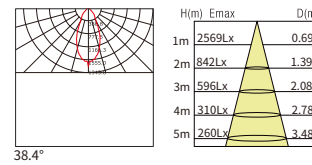





●○ Black or white as standard

### Clean Recessed

Power	CRI	Beam Angle	Luminous Flux	CCT	Housing	Model Number
7W	>90	15°	630lm	2700K	white	CLER07S-W2715
			680lm	3000K	black	CLER07S-B3015
			720lm	4000K	black	CLER07S-B4015
		23°	630lm	2700K	black	CLER07S-B2723
			680lm	3000K	white	CLER07S-B3023
			720lm	4000K	black	CLER07S-B4023
		38°	630lm	2700K	black	CLER07S-B2738
			680lm	3000K	black	CLER07S-B3038
			720lm	4000K	white	CLER07S-W4038

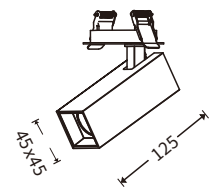
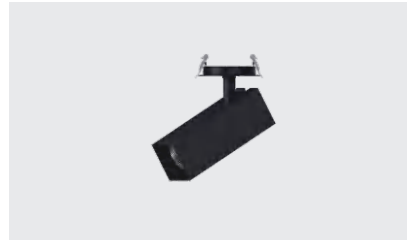

(mm)

cut out:Φ78

#### Angle



#### LED & Driver

CREE COB:  
Power: 7W/LED  
Voltage: 18V  
SDCM<6  
KEGU driver:  
Input voltage:100-240VAC  
/220-240V/110-130V  
Output current:180mA  
Output voltage:DC12-24V

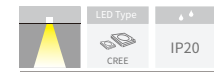
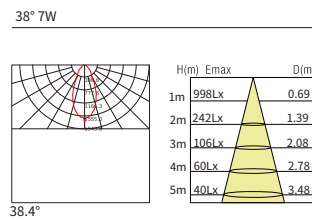

●○ Black or white as standard

### Clean Recessed

Power	CRI	Beam Angle	Luminous Flux	CCT	Housing	Model Number
12W	>90	15°	1080lm	2700K	white	CLER12S-W2715
			1140lm	3000K	black	CLER12S-B3015
			1200lm	4000K	white	CLER12S-W4015
		23°	1080lm	2700K	black	CLER12S-B2723
			1140lm	3000K	white	CLER12S-W3023
			1200lm	4000K	black	CLER12S-B4023
		38°	1080lm	2700K	white	CLER12S-W2738
			1140lm	3000K	black	CLER12S-B3038
			1200lm	4000K	white	CLER12S-W4038

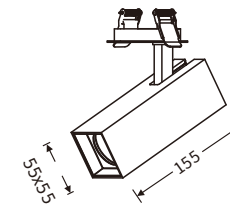
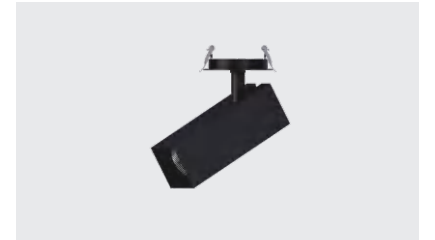

(mm)

cut out:Φ78

#### Angle



#### LED & Driver

CREE COB:  
Power: 12W/LED  
Voltage: 36V  
SDCM<6  
KEGU driver:  
Input voltage:100-240VAC  
/220-240V/110-130V  
Output current:300mA  
Output voltage:DC24-42V

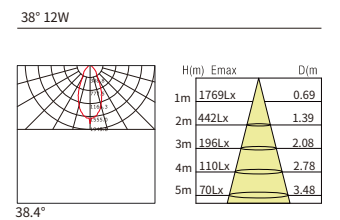



LED Type: CREE IP20 ●○ Black or white as standard

### Clean Recessed

Power	CRI	Beam Angle	Luminous Flux	CCT	Housing	Model Number
20W	>90	15°	1800lm	2700K	white	CLER20S-W2715
			1860lm	3000K	black	CLER20S-B3015
			1920lm	4000K	white	CLER20S-W4015
		23°	1800lm	2700K	black	CLER20S-B2723
			1860lm	3000K	white	CLER20S-W3023
			1920lm	4000K	black	CLER20S-B4023
		38°	1800lm	2700K	white	CLER20S-W2738
			1860lm	3000K	black	CLER20S-B3038
			1920lm	4000K	white	CLER20S-W4038

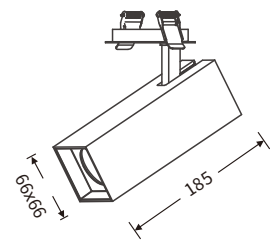

(mm)

cut out:Φ88

#### Angle



#### LED & Driver

CREE COB:  
Power: 20W/LED  
Voltage: 36V  
SDCM<6  
KEGU driver:  
Input voltage:100-240VAC  
/220-240V/110-130V  
Output current:600mA  
Output voltage:DC24-45V



38° 20W

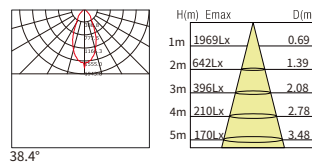

38.4°



LED Type: CREE IP20 ●○ Black or white as standard

### Clean Recessed

Power	CRI	Beam Angle	Luminous Flux	CCT	Housing	Model Number
30W	>90	15°	2700lm	2700K	white	CLER30S-W2715
			2760lm	3000K	black	CLER30S-B3015
			2820lm	4000K	white	CLER30S-W4015
		23°	2700lm	2700K	black	CLER30S-B2723
			2760lm	3000K	white	CLER30S-W3023
			2820lm	4000K	black	CLER30S-B4023
		38°	2700lm	2700K	white	CLER30S-W2738
			2760lm	3000K	black	CLER30S-B3038
			2820lm	4000K	white	CLER30S-W4038

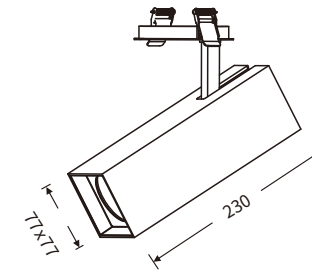

(mm)

cut out:Φ98

#### Angle



#### LED & Driver

CREE COB:  
Power: 30W/LED  
Voltage: 36V  
SDCM<6  
KEGU driver:  
Input voltage:100-240VAC  
/220-240V/110-130V  
Output current:700mA  
Output voltage:DC24-54V



38° 30W

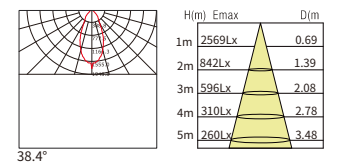

38.4°





## Clean Ceiling

LED Type: CREE IP20 ●○ Black or white as standard

Power	CRI	Beam Angle	Luminous Flux	CCT	Housing	Model Number
7W	>90	15°	630lm	2700K	white	CLEC07S-W2715
			680lm	3000K	black	CLEC07S-B3015
			720lm	4000K	black	CLEC07S-B4015
		23°	630lm	2700K	black	CLEC07S-B2723
			680lm	3000K	white	CLEC07S-W3023
			720lm	4000K	black	CLEC07S-B4023
38°	630lm	2700K	black	CLEC07S-B2738		
	680lm	3000K	black	CLEC07S-B3038		
	720lm	4000K	white	CLEC07S-W4038		

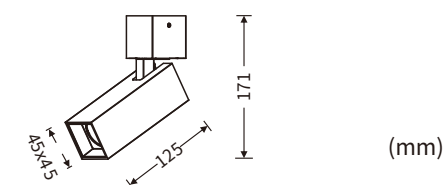

### Angle



### LED & Driver

CREE COB:  
 Power: 7W/LED  
 Voltage: 18V  
 SDCM<6  
 KEGU driver:  
 Input voltage:100-240VAC  
 /220-240V/110-130V  
 Output current:180mA  
 Output voltage:DC12-24V



38° 7W

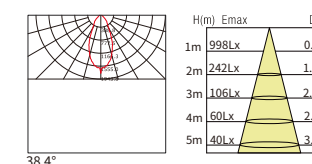

LED Type: CREE IP20 ●○ Black or white as standard

Power	CRI	Beam Angle	Luminous Flux	CCT	Frame	Model Number
12W	>90	15°	1080lm	2700K	white	CLEC12S-W2715
			1140lm	3000K	black	CLEC12S-B3015
			1200lm	4000K	white	CLEC12S-W4015
		23°	1080lm	2700K	black	CLEC12S-B2723
			1140lm	3000K	white	CLEC12S-W3023
			1200lm	4000K	black	CLEC12S-B4023
		38°	1080lm	2700K	white	CLEC12S-W2738
			1140lm	3000K	black	CLEC12S-B3038
			1200lm	4000K	white	CLEC12S-W4038

### Clean Ceiling

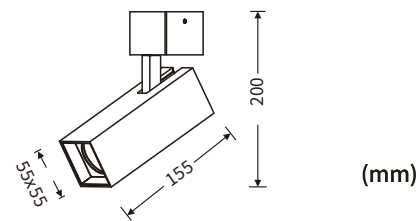
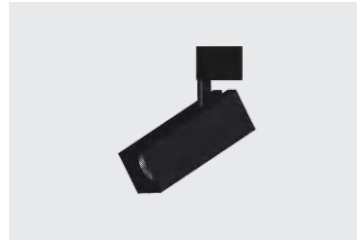

### Angle



### LED & Driver

CREE COB:  
 Power: 12W/LED  
 Voltage: 36V  
 SDCM<6  
 KEGU driver:  
 Input voltage:100-240VAC  
 /220-240V/110-130V  
 Output current:300mA  
 Output voltage:DC24-42V

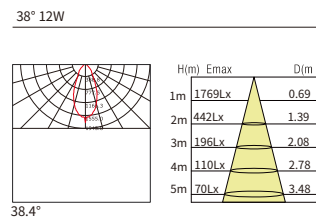

LED Type: CREE IP20 ●○ Black or white as standard

Power	CRI	Beam Angle	Luminous Flux	CCT	Housing	Model Number
20W	>90	15°	1800lm	2700K	white	CLEC20S-W2715
			1860lm	3000K	black	CLEC20S-B3015
			1920lm	4000K	white	CLEC20S-W4015
			1920lm	4000K	black	CLEC20S-B4023
		23°	1800lm	2700K	black	CLEC20S-B2723
			1860lm	3000K	white	CLEC20S-W3023
			1920lm	4000K	black	CLEC20S-B4023
			1920lm	4000K	white	CLEC20S-W4038
		38°	1800lm	2700K	white	CLEC20S-W2738
			1860lm	3000K	black	CLEC20S-B3038
			1860lm	3000K	black	CLEC20S-B3038
			1920lm	4000K	white	CLEC20S-W4038

### Clean Ceiling

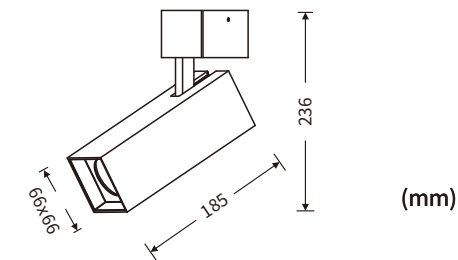

### Angle



### LED & Driver

CREE COB:  
 Power: 20W/LED  
 Voltage: 36V  
 SDCM<6  
 KEGU driver:  
 Input voltage:100-240VAC  
 /220-240V/110-130V  
 Output current:600mA  
 Output voltage:DC24-45V

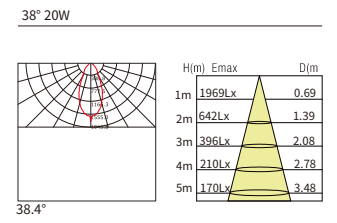



## Clean Ceiling

LED Type: CREE IP20 ●○ Black or white as standard

Power	CRI	Beam Angle	Luminous Flux	CCT	Frame	Model Number
30W	>90	15°	2700lm	2700K	white	CLEC30S-W2715
			2760lm	3000K	black	CLEC30S-B3015
			2820lm	4000K	white	CLEC30S-W4015
		23°	2700lm	2700K	black	CLEC30S-B2723
			2760lm	3000K	white	CLEC30S-W3023
			2820lm	4000K	black	CLEC30S-B4023
38°	2700lm	2700K	white	CLEC30S-W2738		
	2760lm	3000K	black	CLEC30S-B3038		
	2820lm	4000K	white	CLEC30S-W4038		

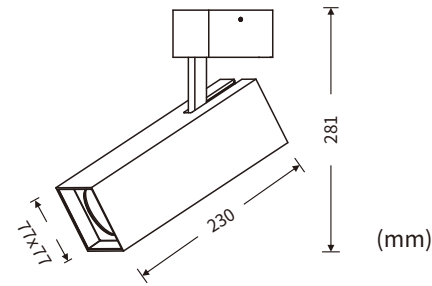

### Angle



### LED & Driver

CREE COB:  
 Power: 30W/LED  
 Voltage: 36V  
 SDCM<6  
 KEGU driver:  
 Input voltage:100-240VAC  
 /220-240V/110-130V  
 Output current:700mA  
 Output voltage:DC24-54V



38° 30W

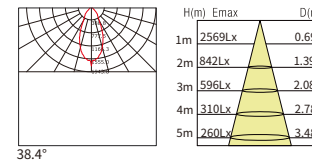

### Clean Surface

### Clean Surface

LED Type: CREE IP20 ●○ Black or white as standard

Power	CRI	Beam Angle	Luminous Flux	CCT	Housing	Model Number
20W	>90	15°	1800lm	2700K	white	CLES20S-W2715
			1860lm	3000K	black	CLES20S-B3015
			1920lm	4000K	white	CLES20S-W4015
		23°	1800lm	2700K	black	CLES20S-B2723
			1860lm	3000K	white	CLES20S-W3023
			1920lm	4000K	black	CLES20S-B4023
38°	1800lm	2700K	white	CLES20S-W2738		
	1860lm	3000K	black	CLES20S-B3038		
	1920lm	4000K	white	CLES20S-W4038		

LED Type: CREE IP20 ●○ Black or white as standard

Power	CRI	Beam Angle	Luminous Flux	CCT	Housing	Model Number
30W	>90	15°	2700lm	2700K	white	CLES30S-W2715
			2760lm	3000K	black	CLES30S-B3015
			2820lm	4000K	white	CLES30S-W4015
			2700lm	2700K	black	CLES30S-B2723
		23°	2700lm	2700K	black	CLES30S-B2723
			2760lm	3000K	white	CLES30S-W3023
			2820lm	4000K	black	CLES30S-B4023
			2700lm	2700K	white	CLES30S-W2738
		38°	2700lm	2700K	white	CLES30S-W2738
			2760lm	3000K	black	CLES30S-B3038
			2820lm	4000K	white	CLES30S-W4038

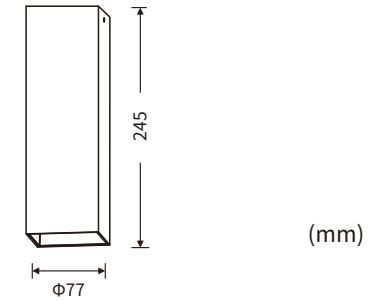
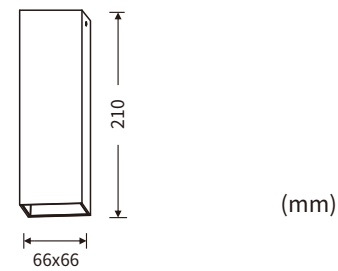

#### LED & Driver

CREE COB:  
 Power: 20W/LED  
 Voltage: 36V  
 SDCM<6  
 KEGU driver:  
 Input voltage:100-240VAC  
 /220-240V/110-130V  
 Output current:600mA  
 Output voltage:DC24-45V



38° 20W

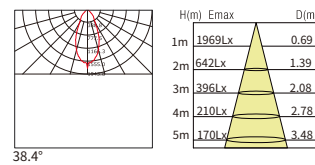

#### LED & Driver

CREE COB:  
 Power: 30W/LED  
 Voltage: 36V  
 SDCM<6  
 KEGU driver:  
 Input voltage:100-240VAC  
 /220-240V/110-130V  
 Output current:700mA  
 Output voltage:DC24-54V



38° 30W

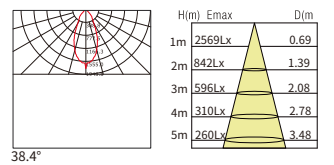

LED Type: CREE IP20 ●○ Black or white as standard **Clean square**

Power	CRI	Beam Angle	Luminous Flux	CCT	Housing	Model Number
7W	>90	15°	630lm	2700K	white	CLES07S-W2715
			680lm	3000K	black	CLES07S-B3015
			720lm	4000K	black	CLES07S-B4015
		23°	630lm	2700K	black	CLES07S-B2723
			680lm	3000K	white	CLES07S-W3023
			720lm	4000K	black	CLES07S-B4023
		38°	630lm	2700K	black	CLES07S-B2738
			680lm	3000K	black	CLES07S-B3038
			720lm	4000K	white	CLES07S-W4038

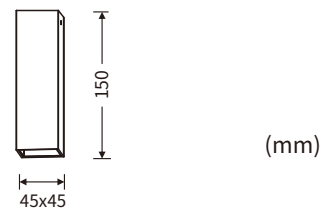

**LED & Driver**

CREE COB:  
 Power: 7W/LED  
 Voltage: 18V  
 SDCM<6  
 KEGU driver:  
 Input voltage:100-240VAC  
 /220-240V/110-130V  
 Output current:180mA  
 Output voltage:DC12-24V

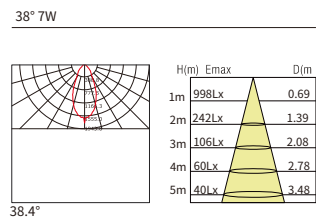

LED Type: CREE IP20 ●○ Black or white as standard **Clean square**

Power	CRI	Beam Angle	Luminous Flux	CCT	Housing	Model Number
12W	>90	15°	1080lm	2700K	white	CLES12S-W2715
			1140lm	3000K	black	CLES12S-B3015
			1200lm	4000K	white	CLES12S-W4015
		23°	1080lm	2700K	black	CLES12S-B2723
			1140lm	3000K	white	CLES12S-W3023
			1200lm	4000K	black	CLES12S-B4023
		38°	1080lm	2700K	white	CLES12S-W2738
			1140lm	3000K	black	CLES12S-B3038
			1200lm	4000K	white	CLES12S-W4038

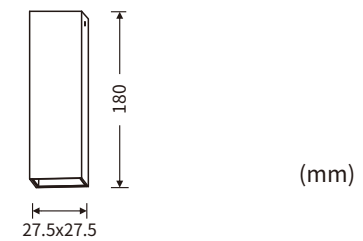

**LED & Driver**

CREE COB:  
 Power: 12W/LED  
 Voltage: 36V  
 SDCM<6  
 KEGU driver:  
 Input voltage:100-240VAC  
 /220-240V/110-130V  
 Output current:300mA  
 Output voltage:DC24-42V

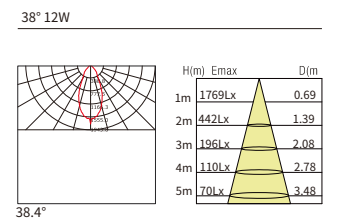



LED Type: CREE IP20 ●○ Black or white as standard

Power	CRI	Beam Angle	Luminous Flux	CCT	Housing	Model Number
7W	>90	15°	630lm	2700K	white	CLESU07S-W2715
			680lm	3000K	black	CLESU07S-B3015
			720lm	4000K	black	CLESU07S-B4015
		23°	630lm	2700K	black	CLESU07S-B2723
			680lm	3000K	white	CLESU07S-W3023
			720lm	4000K	black	CLESU07S-B4023
		38°	630lm	2700K	black	CLESU07S-B2738
			680lm	3000K	black	CLESU07S-B3038
			720lm	4000K	white	CLESU07S-W4038

### Clean Suspended

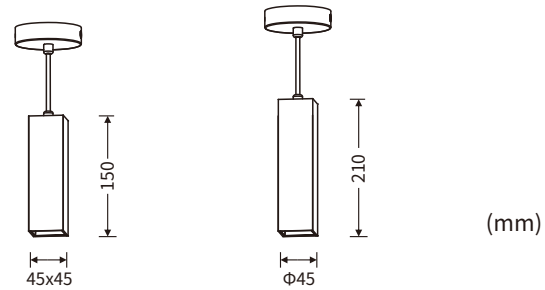

#### LED & Driver

CREE COB:  
Power: 7W/LED  
Voltage: 18V  
SDCM<6  
KEGU driver:  
Input voltage:100-240VAC  
/220-240V/110-130V  
Output current:180mA  
Output voltage:DC12-24V

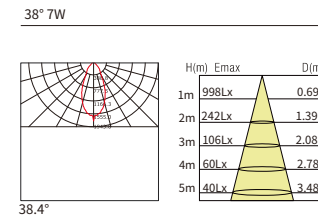

LED Type: CREE IP20 ●○ Black or white as standard

Power	CRI	Beam Angle	Luminous Flux	CCT	Housing	Model Number
12W	>90	15°	1080lm	2700K	white	CLESU12S-W2715
			1140lm	3000K	black	CLESU12S-B3015
			1200lm	4000K	white	CLESU12S-W4015
		23°	1080lm	2700K	black	CLESU12S-B2723
			1140lm	3000K	white	CLESU12S-W3023
			1200lm	4000K	black	CLESU12S-B4023
		38°	1080lm	2700K	white	CLESU12S-W2738
			1140lm	3000K	black	CLESU12S-B3038
			1200lm	4000K	white	CLESU12S-W4038

### Clean Suspended

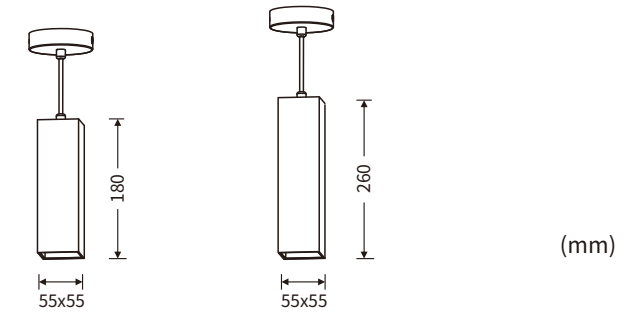

#### LED & Driver

CREE COB:  
Power: 12W/LED  
Voltage: 36V  
SDCM<6  
KEGU driver:  
Input voltage:100-240VAC  
/220-240V/110-130V  
Output current:300mA  
Output voltage:DC24-42V

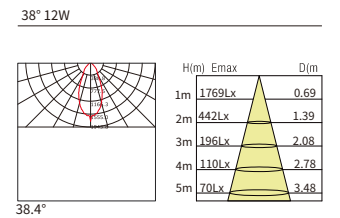

LED Type: CREE IP20 ●○ Black or white as standard

Power	CRI	Beam Angle	Luminous Flux	CCT	Housing	Model Number
20W	>90	15°	1800lm	2700K	white	CLESU20S-W2715
			1860lm	3000K	black	CLESU20S-B3015
			1920lm	4000K	white	CLESU20S-W4015
		23°	1800lm	2700K	black	CLESU20S-B2723
			1860lm	3000K	white	CLESU20S-W3023
			1920lm	4000K	black	CLESU20S-B4023
		38°	1800lm	2700K	white	CLESU20S-W2738
			1860lm	3000K	black	CLESU20S-B3038
			1920lm	4000K	white	CLESU20S-W4038

### Clean Suspended

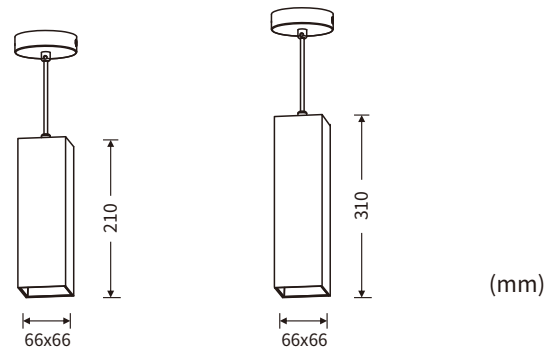

#### LED & Driver

CREE COB:  
 Power: 20W/LED  
 Voltage: 36V  
 SDCM<6  
 KEGU driver:  
 Input voltage:100-240VAC  
 /220-240V/110-130V  
 Output current:600mA  
 Output voltage:DC24-45V



38° 20W

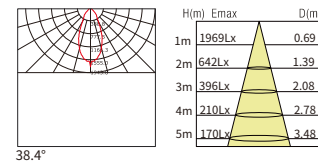

LED Type: CREE IP20 ●○ Black or white as standard

Power	CRI	Beam Angle	Luminous Flux	CCT	Housing	Model Number
30W	>90	15°	2700lm	2700K	white	CLESU30S-W2715
			2760lm	3000K	black	CLESU30S-B3015
			2820lm	4000K	white	CLESU30S-W4015
		23°	2700lm	2700K	black	CLESU30S-B2723
			2760lm	3000K	white	CLESU30S-W3023
			2820lm	4000K	black	CLESU30S-B4023
		38°	2700lm	2700K	white	CLESU30S-W2738
			2760lm	3000K	black	CLESU30S-B3038
			2820lm	4000K	white	CLESU30S-W4038

### Clean Suspended

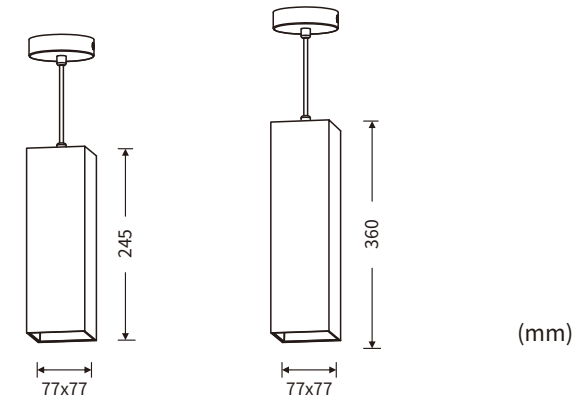

#### LED & Driver

CREE COB:  
 Power: 30W/LED  
 Voltage: 36V  
 SDCM<6  
 KEGU driver:  
 Input voltage:100-240VAC  
 /220-240V/110-130V  
 Output current:700mA  
 Output voltage:DC24-54V



38° 30W

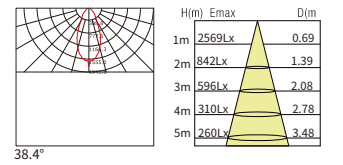

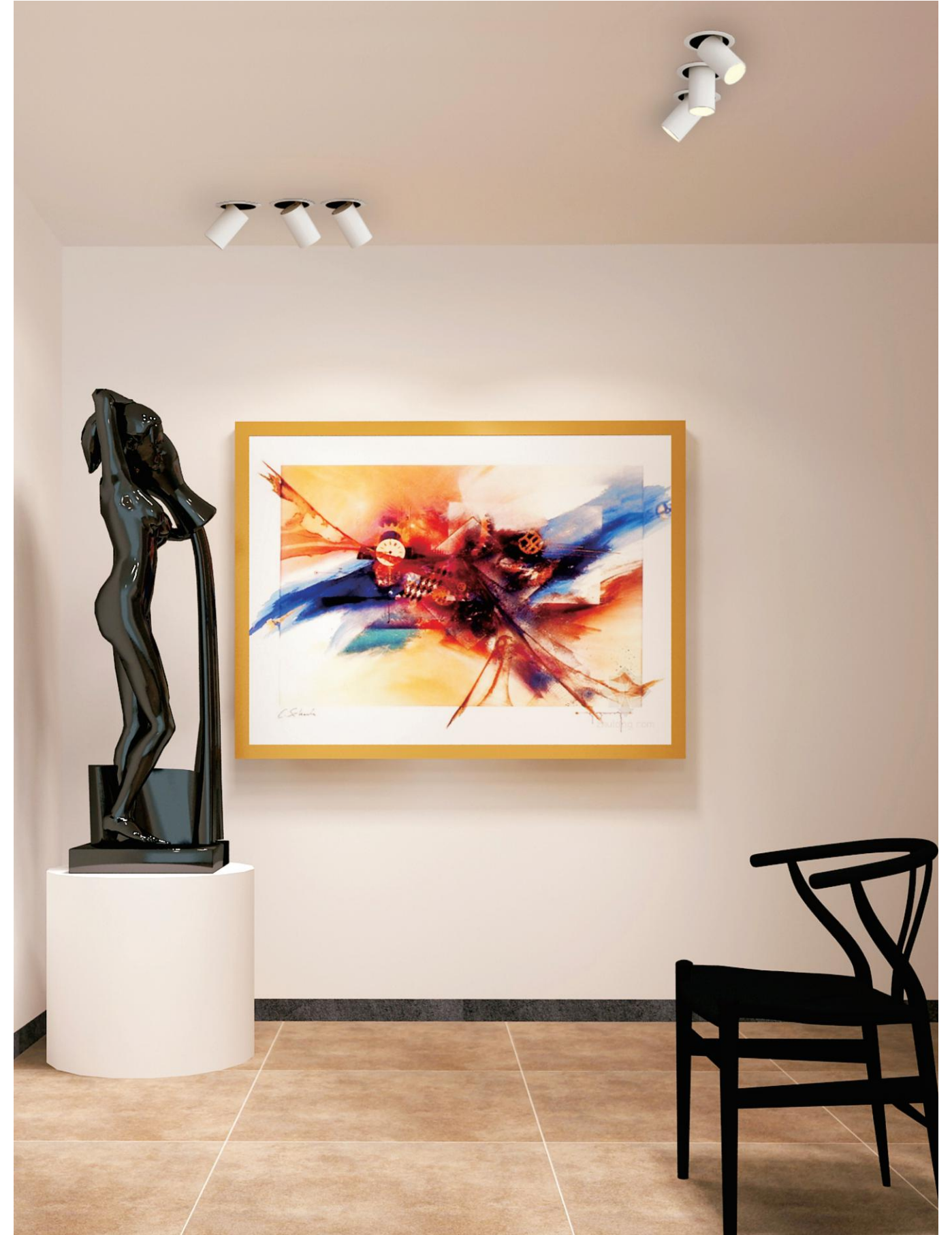



LED Type: CREE, IP20 (IP20 for visible body of fitting after installation), White as standard, InOut

Power	CRI	Beam Angle	Luminous Flux	CCT	Refractive screen	Frame	Model Number
12W	>90	15°	900lm	2700K	black	white	INOUT12-W2715
			930lm	3000K	black	white	INOUT12-W3015
			960lm	4000K	black	white	INOUT12-W4015
		24°	900lm	2700K	black	white	INOUT12-W2724
			930lm	3000K	black	white	INOUT12-W3024
			960lm	4000K	black	white	INOUT12-W4024
		38°	900lm	2700K	black	white	INOUT12-W2738
			930lm	3000K	black	white	INOUT12-W3038
			960lm	4000K	black	white	INOUT12-W4038

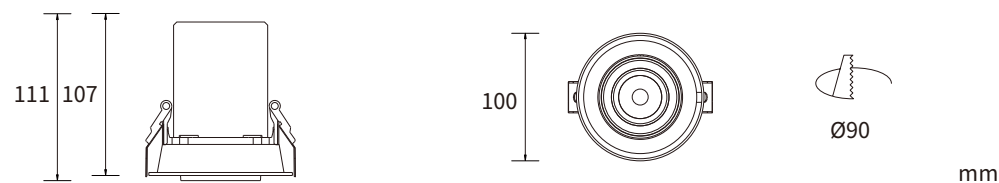

Filter



LED & Driver

CITIZEN/PHILIPS/CREE COB:  
 Power: 10-12W/LED  
 Voltage: 36V  
 SDCM<5  
 Driver:  
 Input Voltage:220-240VAC  
 Output Current:300mA  
 Output Voltage:DC25-42V



G.W.:7.50kgs  
 Packaging:62x25x26cm,20PCS/CTN



LED Type: CREE, IP20 (IP20 for visible body of fitting after installation), White as standard, InOut

Power	CRI	Beam Angle	Luminous Flux	CCT	Refractive screen	Frame	Model Number
30W	>90	15°	2300lm	2700K	black	white	INOUT30-W2715
			2350lm	3000K	black	white	INOUT30-W3015
			2400lm	4000K	black	white	INOUT30-W4015
			2300lm	2700K	black	white	INOUT30-W2724
		24°	2350lm	3000K	black	white	INOUT30-W3024
			2400lm	4000K	black	white	INOUT30-W4024
			2300lm	2700K	black	white	INOUT30-W2738
			2350lm	3000K	black	white	INOUT30-W3038
		38°	2400lm	4000K	black	white	INOUT30-W4038

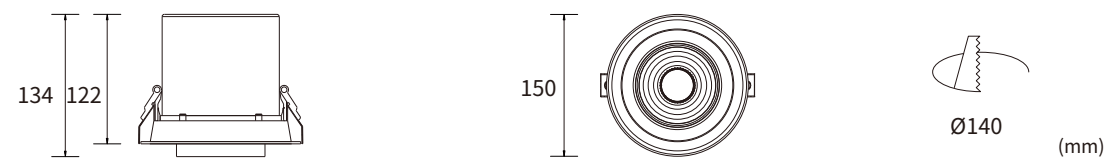

Filter



LED & Driver

CITIZEN/PHILIPS/CREE COB:  
 Power: 25-30W/LED  
 Voltage: 36V  
 SDCM<5  
 Driver:  
 Input Voltage:220-240VAC  
 Output Current:700mA  
 Output Voltage:DC32-42V



G.W.:8.50kgs  
 Packaging:32x32x37cm,8PCS/CTN



LED Type: CREE, IP20 (IP20 for visible body of fitting after installation), White as standard, InOut

Power	CRI	Beam Angle	Luminous Flux	CCT	Refractive screen	Frame	Model Number
12W	>90	15°	900lm	2700K	black	white	INOUTS12-W2715
			930lm	3000K	black	white	INOUTS12-W3015
			960lm	4000K	black	white	INOUTS12-W4015
		24°	900lm	2700K	black	white	INOUTS12-W2724
			930lm	3000K	black	white	INOUTS12-W3024
			960lm	4000K	black	white	INOUTS12-W4024
		38°	900lm	2700K	black	white	INOUTS12-W2738
			930lm	3000K	black	white	INOUTS12-W3038
			960lm	4000K	black	white	INOUTS12-W4038

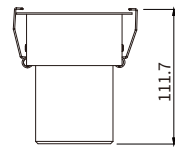
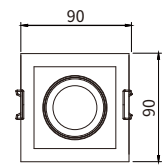

75x75 mm

LED Type: CREE, IP20 (IP20 for visible body of fitting after installation), White as standard, InOut

Power	CRI	Beam Angle	Luminous Flux	CCT	Refractive screen	Frame	Model Number
2x12W	>90	15°	1800lm	2700K	black	white	INOUT212-W2715
			1860lm	3000K	black	white	INOUT212-W3015
			1920lm	4000K	black	white	INOUT212-W4015
			1800lm	2700K	black	white	INOUT212-W2724
			1860lm	3000K	black	white	INOUT212-W3024
			1920lm	4000K	black	white	INOUT212-W4024
		24°	1800lm	2700K	black	white	INOUT212-W2738
			1860lm	3000K	black	white	INOUT212-W3038
			1920lm	4000K	black	white	INOUT212-W4038
			1800lm	2700K	black	white	INOUT212-W2715
			1860lm	3000K	black	white	INOUT212-W3015
			1920lm	4000K	black	white	INOUT212-W4015
		38°	1800lm	2700K	black	white	INOUT212-W2724
			1860lm	3000K	black	white	INOUT212-W3024
			1920lm	4000K	black	white	INOUT212-W4024
			1800lm	2700K	black	white	INOUT212-W2738
			1860lm	3000K	black	white	INOUT212-W3038
			1920lm	4000K	black	white	INOUT212-W4038

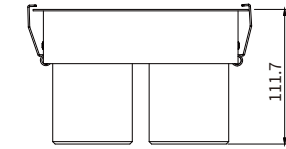
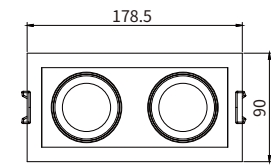

170x75 mm

Filter



LED & Driver

CITIZEN/PHILIPS/CREE COB:  
 Power: 10-12W/LED  
 Voltage: 36V  
 SDCM<5  
 Driver:  
 Input Voltage:220-240VAC  
 Output Current:300mA  
 Output Voltage:DC25-42V



G.W.:7.50kgs  
 Packaging:62x25x26cm,20PCS/CTN



Filter

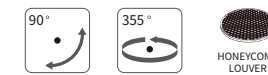

LED & Driver

CITIZEN/PHILIPS/CREE COB:  
 Power: 10-12W/LED  
 Voltage: 36V  
 SDCM<5  
 Driver:  
 Input Voltage:220-240VAC  
 Output Current:300mA  
 Output Voltage:DC25-42V



G.W.:7.50kgs  
 Packaging:62x25x26cm,20PCS/CTN





## Jerry

---

Long stem design to offer special and minimalist style, clean light effect and same as our other items available in round and square. Customized optional two spots on the stem.





LED Type: CREE IP20 ●○ Black or white as standard **Jerry Track**

Power	CRI	Beam Angle	Luminous Flux	CCT	Housing	Model Number
20W	>90	15°	1800lm	2700K	black	JERRY20R-B2715
			1860lm	3000K	white	JERRY20R-W3015
			1920lm	4000K	black	JERRY20R-B4015
		23°	1800lm	2700K	white	JERRY20R-W2723
			1860lm	3000K	black	JERRY20R-B3023
			1920lm	4000K	black	JERRY20R-B4023
		38°	1800lm	2700K	black	JERRY20R-B2738
			1860lm	3000K	black	JERRY20R-B3038
			1920lm	4000K	white	JERRY20R-B4038

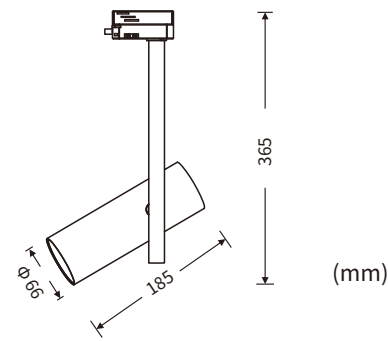

Angle



LED & Driver

CREE COB:  
 Power: 20W/LED  
 Voltage: 36V  
 SDCM<5  
 KEGU driver:  
 Input voltage:100-240VAC  
 /220-240V/110-130V  
 Output current:600mA  
 Output voltage:DC24-45V



38° 20W

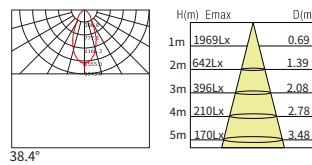

LED Type: CREE IP20 ●○ Black or white as standard **Jerry Track**

Power	CRI	Beam Angle	Luminous Flux	CCT	Frame	Model Number
30W	>90	15°	2700lm	2700K	black	JERRY30R-B2715
			2760lm	3000K	white	JERRY30R-W3015
			2820lm	4000K	black	JERRY30R-B4015
		23°	2700lm	2700K	white	JERRY30R-W2723
			2760lm	3000K	black	JERRY30R-B3023
			2820lm	4000K	black	JERRY30R-B4023
		38°	2700lm	2700K	black	JERRY30R-B2738
			2760lm	3000K	black	JERRY30R-B3038
			2820lm	4000K	white	JERRY30R-B4038

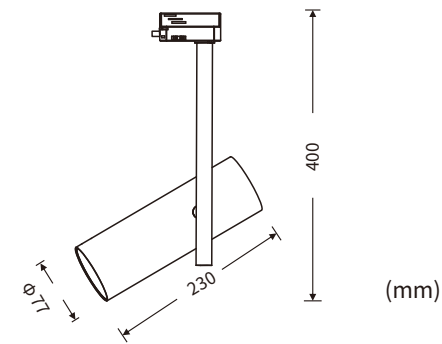

Angle



LED & Driver

CREE COB:  
 Power: 30W/LED  
 Voltage: 36V  
 SDCM<5  
 KEGU driver:  
 Input voltage:100-240VAC  
 /220-240V/110-130V  
 Output current:700mA  
 Output voltage:DC24-54V



38° 30W

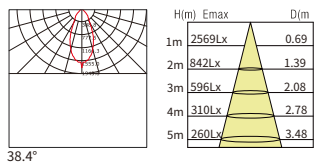

Jerry Track

LED Type: CREE IP20 ●○ Black or white as standard

Power	CRI	Beam Angle	Luminous Flux	CCT	Housing	Model Number
7W	>90	15°	630lm	2700K	black	JERRY07R-B2715
			690lm	3000K	white	JERRY07R-W3015
			750lm	4000K	black	JERRY07R-B4015
		23°	630lm	2700K	white	JERRY07R-W2723
			690lm	3000K	black	JERRY07R-B3023
			750lm	4000K	black	JERRY07R-B4023
38°	630lm	2700K	black	JERRY07R-B2738		
	690lm	3000K	black	JERRY07R-B3038		
	750lm	4000K	white	JERRY07R-B4038		

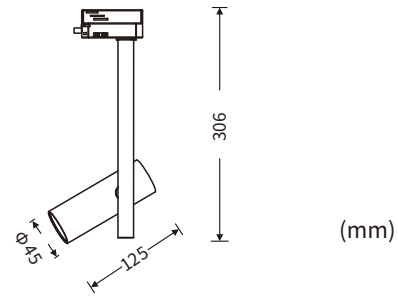

Angle



LED & Driver

CREE COB:  
 Power: 7W/LED  
 Voltage: 18V  
 SDCM<5  
 KEGU driver:  
 Input voltage:100-240VAC  
 /220-240V/110-130V  
 Output current:180mA  
 Output voltage:DC12-24V



38° 7W

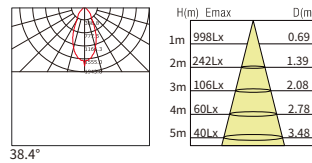

Jerry Track

LED Type: CREE IP20 ●○ Black or white as standard

Power	CRI	Beam Angle	Luminous Flux	CCT	Frame	Model Number
12W	>90	15°	1080lm	2700K	black	JERRY12R-B2715
			1140lm	3000K	white	JERRY12R-W3015
			1200lm	4000K	black	JERRY12R-B4015
		23°	1080lm	2700K	white	JERRY12R-W2723
			1140lm	3000K	black	JERRY12R-B3023
			1200lm	4000K	black	JERRY12R-B4023
38°	1080lm	2700K	black	JERRY12R-B2738		
	1140lm	3000K	black	JERRY12R-B3038		
	1200lm	4000K	white	JERRY12R-B4038		

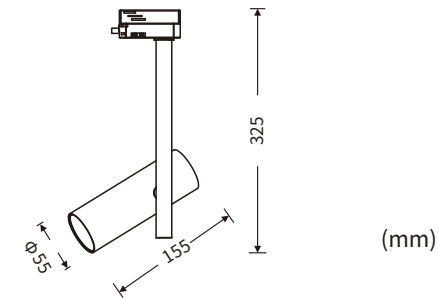

Angle



LED & Driver

CREE COB:  
 Power: 12W/LED  
 Voltage: 36V  
 SDCM<5  
 KEGU driver:  
 Input voltage:100-240VAC  
 /220-240V/110-130V  
 Output current:300mA  
 Output voltage:DC24-42V



38° 12W

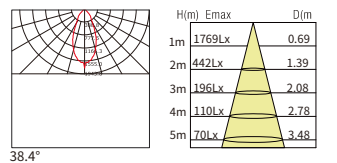

## Jerry Track



## Jerry square

Long stem design to offer special and minimalist style, clean light effect and same as our other items available in round and square. Customized optional two spots on the stem.

LED Type: CREE IP20 ●○ Black or white as standard

Power	CRI	Beam Angle	Luminous Flux	CCT	Housing	Model Number
7W	>90	15°	630lm	2700K	black	JERRY07S-B2715
			690lm	3000K	white	JERRY07S-W3015
			750lm	4000K	black	JERRY07S-B4015
7W	>90	23°	630lm	2700K	white	JERRY07S-W2723
			690lm	3000K	black	JERRY07S-B3023
			750lm	4000K	black	JERRY07S-B4023
7W	>90	38°	630lm	2700K	black	JERRY07S-B2738
			690lm	3000K	black	JERRY07S-B3038
			750lm	4000K	white	JERRY07S-B4038

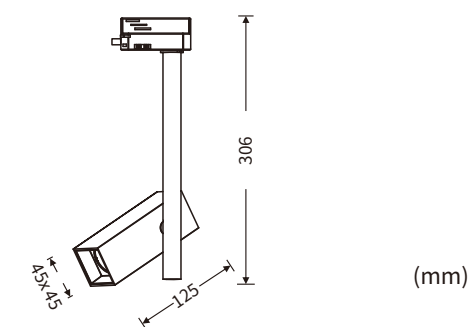

### Angle



### LED & Driver

CREE COB:  
 Power: 7W/LED  
 Voltage: 18V  
 SDCM<5  
 KEGU driver:  
 Input voltage:100-240VAC  
 /220-240V/110-130V  
 Output current:180mA  
 Output voltage:DC12-24V



### 38° 7W

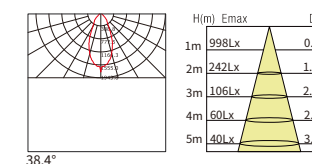



LED Type: CREE IP20 ●○ Black or white as standard

Power	CRI	Beam Angle	Luminous Flux	CCT	Frame	Model Number
12W	>90	15°	1080lm	2700K	black	JERRY12S-B2715
			1140lm	3000K	white	JERRY12S-W3015
			1200lm	4000K	black	JERRY12S-B4015
		23°	1080lm	2700K	white	JERRY12S-W2723
			1140lm	3000K	black	JERRY12S-B3023
			1200lm	4000K	black	JERRY12S-B4023
		38°	1080lm	2700K	black	JERRY12S-B2738
			1140lm	3000K	black	JERRY12S-B3038
			1200lm	4000K	white	JERRY12S-B4038

## Jerry Track

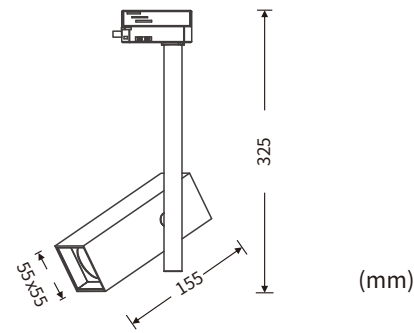

### Angle



### LED & Driver

CREE COB:  
 Power: 12W/LED  
 Voltage: 36V  
 SDCM<5  
 KEGU driver:  
 Input voltage:100-240VAC  
 /220-240V/110-130V  
 Output current:300mA  
 Output voltage:DC24-42V

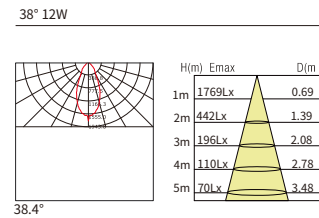

LED Type: CREE IP20 ●○ Black or white as standard

Power	CRI	Beam Angle	Luminous Flux	CCT	Housing	Model Number
20W	>90	15°	1800lm	2700K	black	JERRY20S-B2715
			1860lm	3000K	white	JERRY20S-W3015
			1920lm	4000K	black	JERRY20S-B4015
		23°	1800lm	2700K	white	JERRY20S-W2723
			1860lm	3000K	black	JERRY20S-B3023
			1920lm	4000K	black	JERRY20S-B4023
		38°	1800lm	2700K	black	JERRY20S-B2738
			1860lm	3000K	black	JERRY20S-B3038
			1920lm	4000K	white	JERRY20S-B4038

## Jerry Track

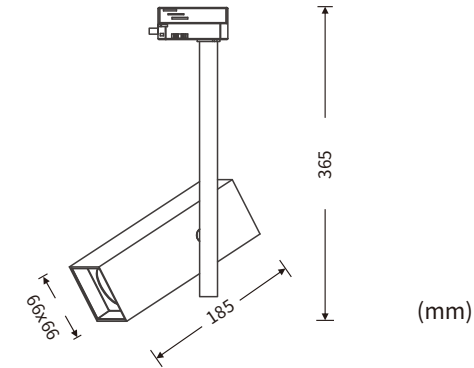

### Angle



### LED & Driver

CREE COB:  
 Power: 20W/LED  
 Voltage: 36V  
 SDCM<5  
 KEGU driver:  
 Input voltage:100-240VAC  
 /220-240V/110-130V  
 Output current:600mA  
 Output voltage:DC24-45V

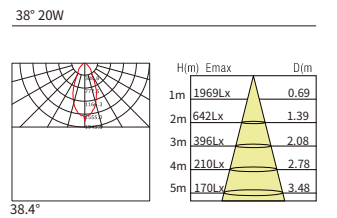

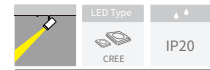

● ○ Black or white as standard

## Jerry Track

Power	CRI	Beam Angle	Luminous Flux	CCT	Frame	Model Number
30W	>90	15°	2700lm	2700K	black	JERRY30S-B2715
			2760lm	3000K	white	JERRY30S-W3015
			2820lm	4000K	black	JERRY30S-B4015
		23°	2700lm	2700K	white	JERRY30S-W2723
			2760lm	3000K	black	JERRY30S-B3023
			2820lm	4000K	black	JERRY30S-B4023
		38°	2700lm	2700K	black	JERRY30S-B2738
			2760lm	3000K	black	JERRY30S-B3038
			2820lm	4000K	white	JERRY30S-B4038

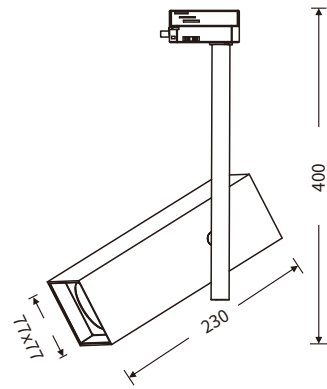

### Angle



### LED & Driver

CREE COB:  
 Power: 30W/LED  
 Voltage: 36V  
 SDCM<5  
 KEGU driver:  
 Input voltage:100-240VAC  
 /220-240V/110-130V  
 Output current:700mA  
 Output voltage:DC24-54V



38° 30W

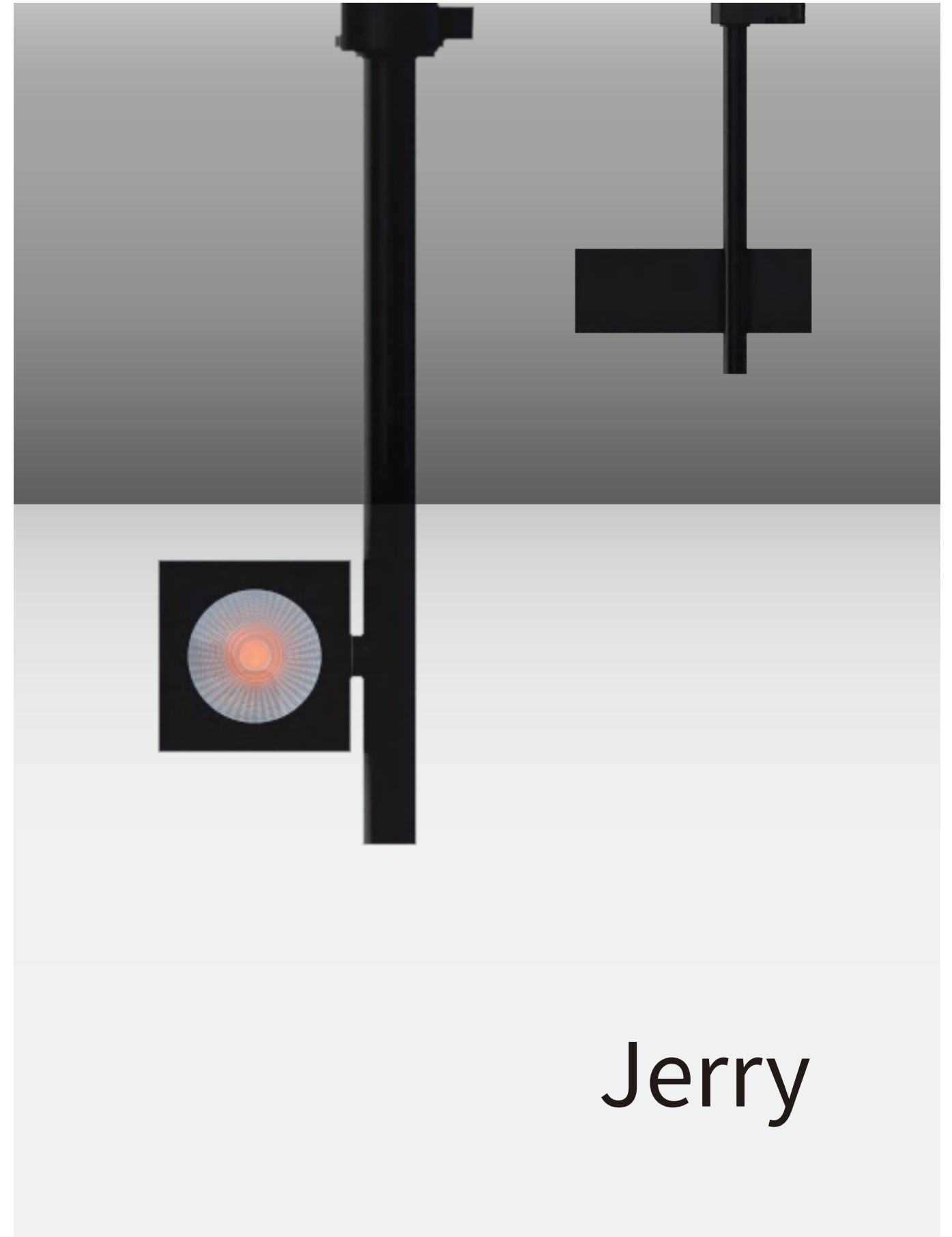
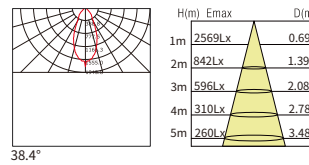

# Jerry



# Drop

Drop is designed for wall washer,  
clean the wall with uniform and emotion comfortable.  
Available in recessed to ceiling and track mounted to 3 phases.

LED Type: CREE  
IP20

○ White color as standard

Power	CRI	Beam Angle	Luminous Flux	CCT	Housing	Model Number
45W	>90		4050lm	2700K	white	DROP45T-W27WW
			5160lm	3000K	white	DROP45T-W30WW
			5220lm	4000K	white	DROP45T-W40WW

## Drop Track

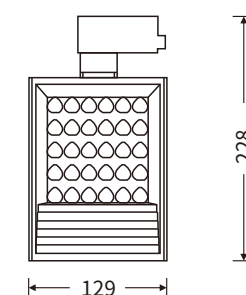
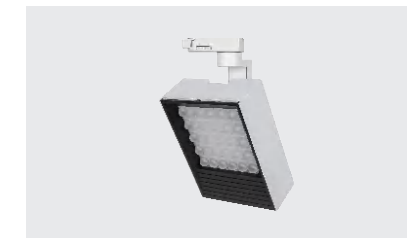

(mm)

### Angle



wall washer 45W

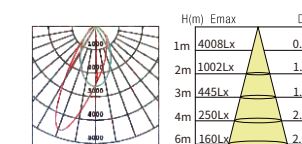

### LED & Driver

CREE COB:  
Power: 45W/LED  
Voltage: 36V  
SDCM<5  
LIFUD driver:  
Input voltage:100-240VAC  
/220-240V/110-130V  
Output current:900mA  
Output voltage:DC30-60V





### Drop Recessed

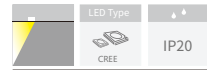

○ White color as standard

Power	CRI	Beam Angle	Luminous Flux	CCT	Housing	Model Number
45W	>90	wall washer	4050lm	2700K	white	DROP45R-W27WW
			5160lm	3000K	white	DROP45R-W30WW
			5220lm	4000K	white	DROP45R-W40WW

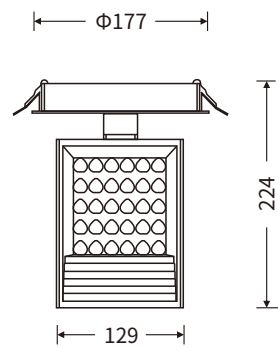

cut out: Φ95 (mm)

wall washer 45W

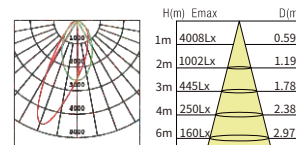

#### Angle



#### LED & Driver

CREE COB:  
 Power: 45W/LED  
 Voltage: 36V  
 SDCM<6  
 LIFUD driver:  
 Input voltage:100-240VAC  
 /220-240V/110-130V  
 Output current:900mA  
 Output voltage:DC30-60V

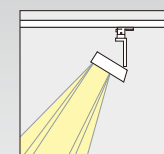
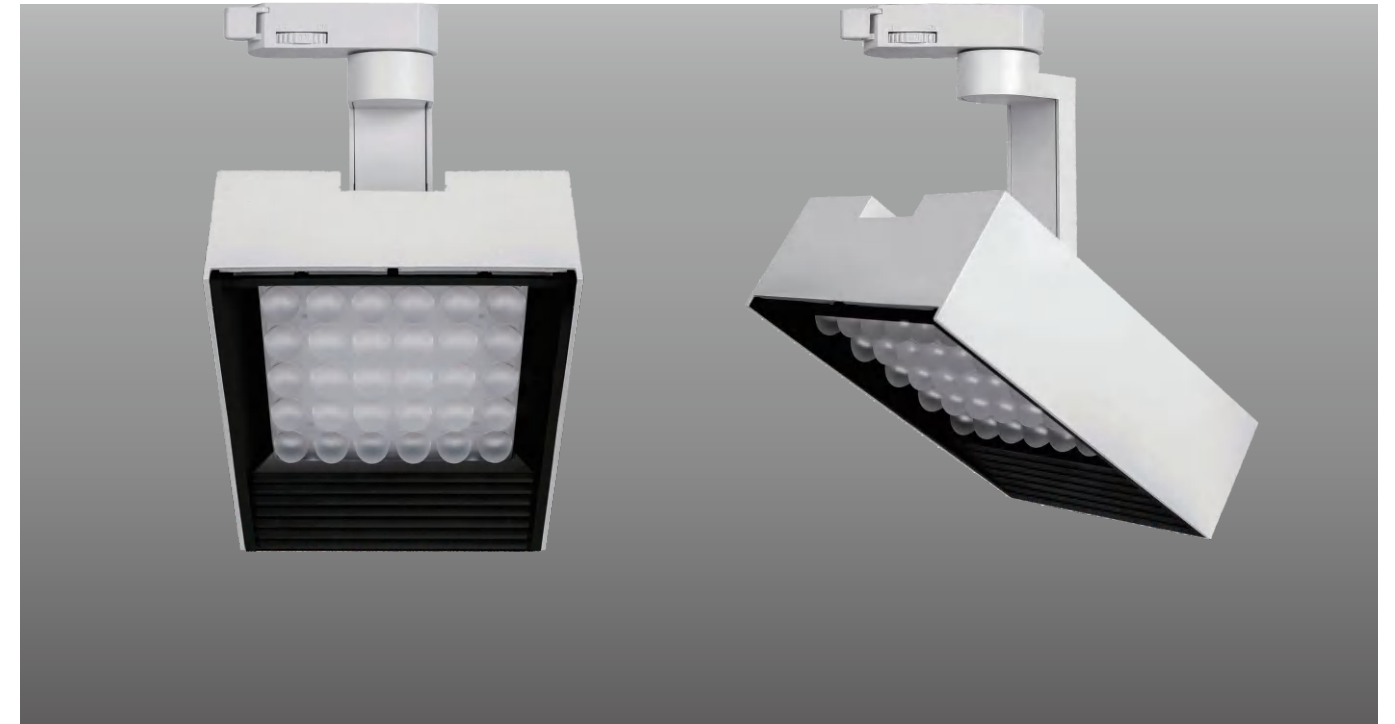

Spotlights  
 symmetrical light distribution  
 for accent lighting.

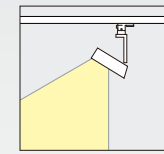

Floodlights  
 floodlighting.

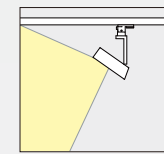

Lens wallwashers  
 Asymmetrical light distribution  
 for highly uniform wallwashing.



# Drop

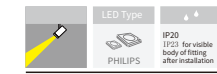
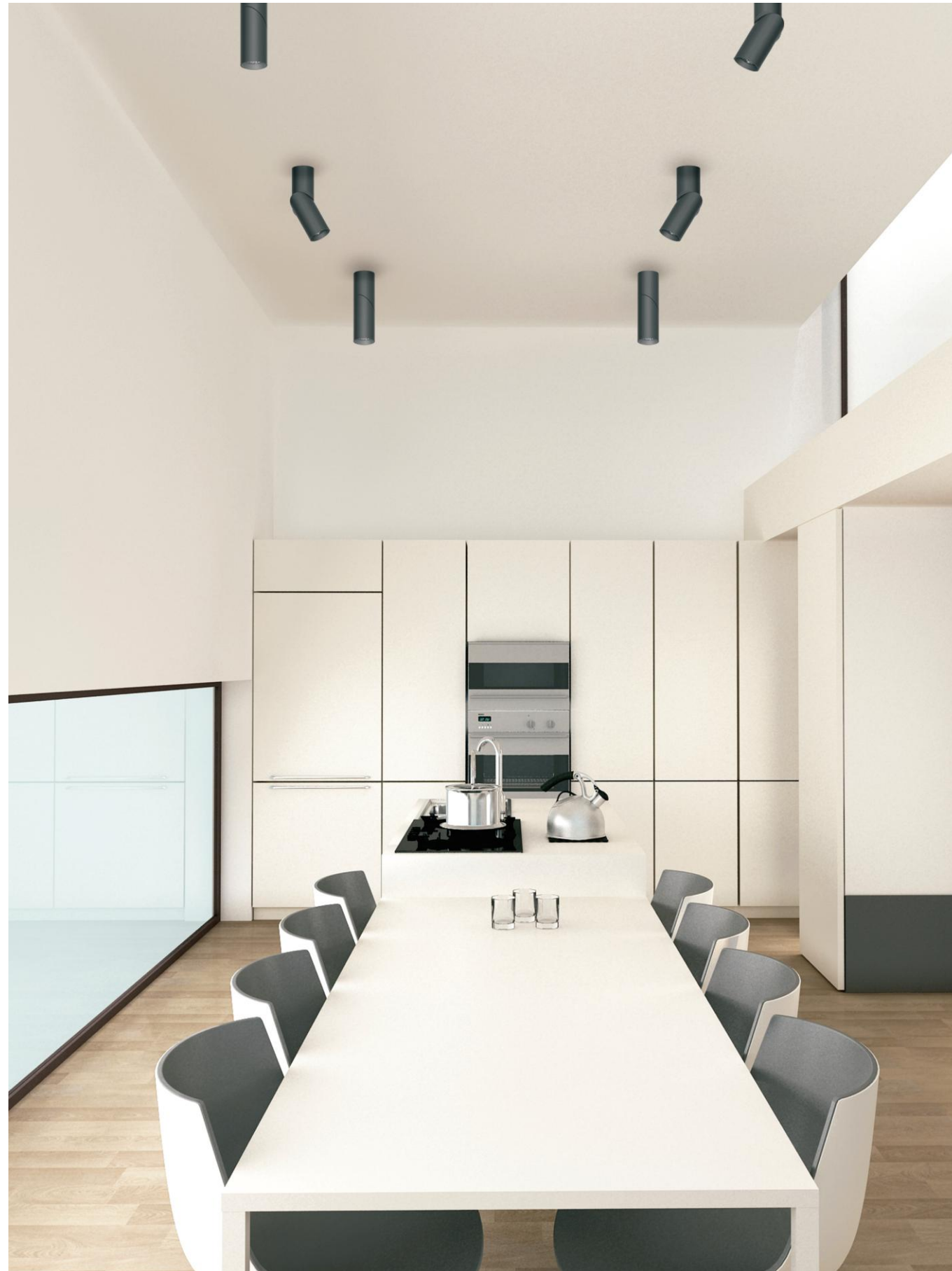

○ White as standard

Power	CRI	Beam Angle	Luminous Flux	CCT	Housing	Model Number
8W	>90	15°	550lm	2700K	white	ALAN08S-W2715
			600lm	3000K	black	ALAN08S-B3015
			650lm	4000K	white	ALAN08S-W4015
		30°	550lm	2700K	black	ALAN08S-B2730
			600lm	3000K	white	ALAN08S-W3030
			650lm	4000K	black	ALAN08S-B4030
50°	550lm	2700K	white	ALAN08S-W2750		
	600lm	3000K	black	ALAN08S-B3050		
	650lm	4000K	white	ALAN08S-W4050		

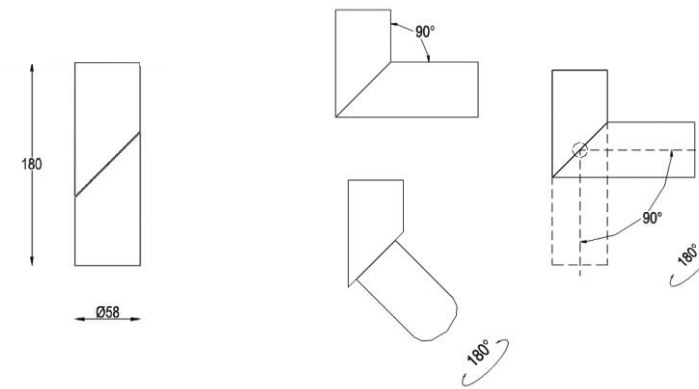

Color Finishing

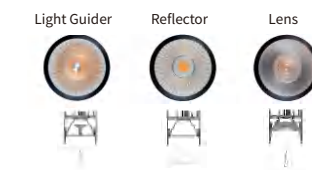

LED & Driver

Philips Lumileds:  
 Power: 7W/LED  
 Voltage: 35V  
 SDCM<3  
 Driver:  
 Input Voltage:220-240VAC  
 Output Current:700mA  
 Output Voltage:DC20-40V



G.W.:21.41kgs  
 Packaging:45x35x60cm,24PCS/CTN



LED Type: PHILIPS, IP20 (IP20 for visible body of fitting after installation), White as standard, Alan

Power	CRI	Beam Angle	Luminous Flux	CCT	Housing	Model Number
15W	>90	15°	1000lm	2700K	white	ALAN15S-W2715
			1100lm	3000K	black	ALAN15S-B3015
			1200lm	4000K	white	ALAN15S-W4015
		30°	1000lm	2700K	black	ALAN15S-B2730
			1100lm	3000K	white	ALAN15S-W3030
			1200lm	4000K	black	ALAN15S-B4030
		50°	1000lm	2700K	white	ALAN15S-W2750
			1100lm	3000K	black	ALAN15S-B3050
			1200lm	4000K	white	ALAN15S-W4050

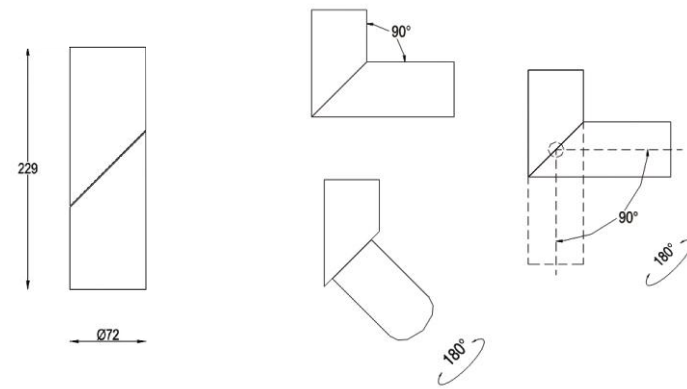

Color Finishing



LED & Driver

Philips Lumileds:  
 Power: 7W/LED  
 Voltage: 35V  
 SDCM<3  
 Driver:  
 Input Voltage:220-240VAC  
 Output Current:700mA  
 Output Voltage:DC20-40V



G.W.:21.41kgs  
 Packaging:45x35x60cm,24PCS/CTN



30° 28W

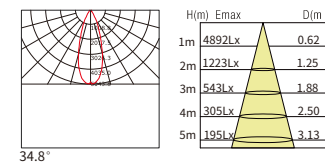

LED Type: PHILIPS, IP20 (IP20 for visible body of fitting after installation), White as standard, Alan

Power	CRI	Beam Angle	Luminous Flux	CCT	Housing	Model Number
8W	>90	15°	550lm	2700K	white	ALAN08-W2715
			600lm	3000K	black	ALAN08-B3015
			650lm	4000K	white	ALAN08-W4015
		30°	550lm	2700K	black	ALAN08-B2730
			600lm	3000K	white	ALAN08-W3030
			650lm	4000K	black	ALAN08-B4030
		50°	550lm	2700K	white	ALAN08-W2750
			600lm	3000K	black	ALAN08-B3050
			650lm	4000K	white	ALAN08-W4050

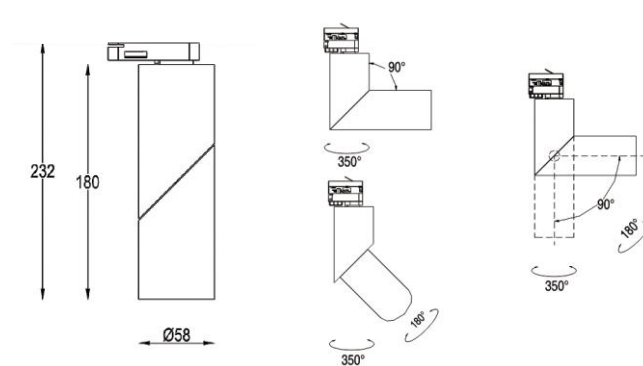
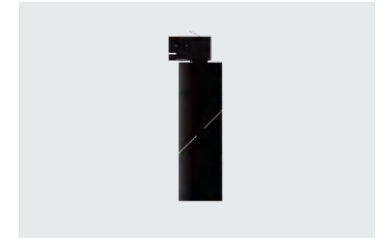
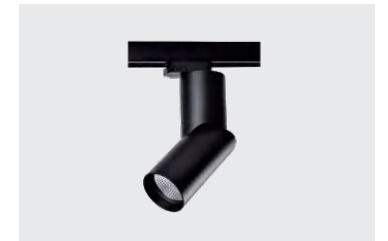

Color Finishing



LED & Driver

Philips Lumileds:  
 Power: 7W/LED  
 Voltage: 35V  
 SDCM<3  
 Driver:  
 Input Voltage:220-240VAC  
 Output Current:700mA  
 Output Voltage:DC20-40V



G.W.:21.41kgs  
 Packaging:45x35x60cm,24PCS/CTN



30° 28W

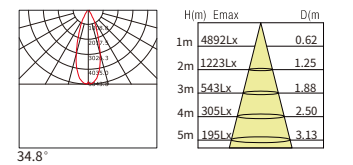





○ White as standard

## Alan

Power	CRI	Beam Angle	Luminous Flux	CCT	Housing	Model Number
15W	>90	15°	1000lm	2700K	white	ALAN15-W2715
			1100lm	3000K	black	ALAN15-B3015
			1200lm	4000K	white	ALAN15-W4015
		30°	1000lm	2700K	black	ALAN15-B2730
			1100lm	3000K	white	ALAN15-W3030
			1200lm	4000K	black	ALAN15-B4030
		50°	1000lm	2700K	white	ALAN15-W2750
			1100lm	3000K	black	ALAN15-B3050
			1200lm	4000K	white	ALAN15-W4050

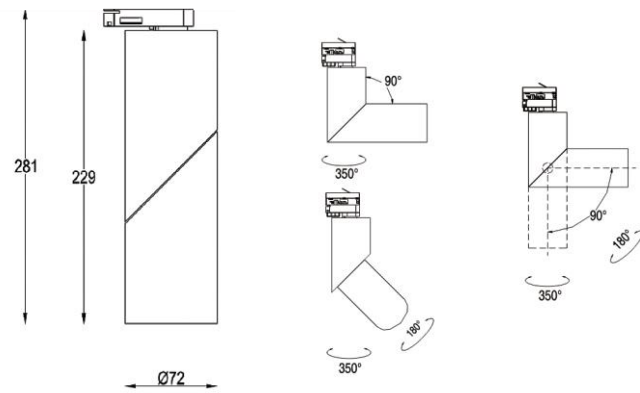

### Color Finishing



### LED & Driver

Philips Lumileds:  
 Power: 7W/LED  
 Voltage: 35V  
 SDCM<3  
 Driver:  
 Input Voltage:220-240VAC  
 Output Current:700mA  
 Output Voltage:DC20-40V



G.W.:21.41kgs  
 Packaging:45x35x60cm,24PCS/CTN



30° 28W

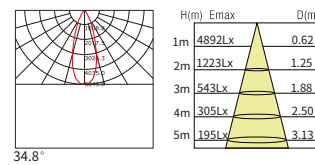



LED Type PHILIPS IP20 (IP20 for visible body of fitting after installation)  White as standard **Ivy**

Power	CRI	Beam Angle	Luminous Flux	CCT	Track	Frame	Model Number
15W	>90	15°	1150lm	2700K	3 circuit	white	IVY15-W2715T
			1200lm	3000K	3 circuit	black	IVY15-B3015T
			1250lm	4000K	3 circuit	white	IVY15-W4015T
		30°	1150lm	2700K	3 circuit	black	IVY15-B2730T
			1200lm	3000K	3 circuit	white	IVY15-W3030T
			1250lm	4000K	3 circuit	black	IVY15-B4030T
		50°	1150lm	2700K	3 circuit	white	IVY15-W2750T
			1200lm	3000K	3 circuit	black	IVY15-B3050T
			1250lm	4000K	3 circuit	white	IVY15-W4050T

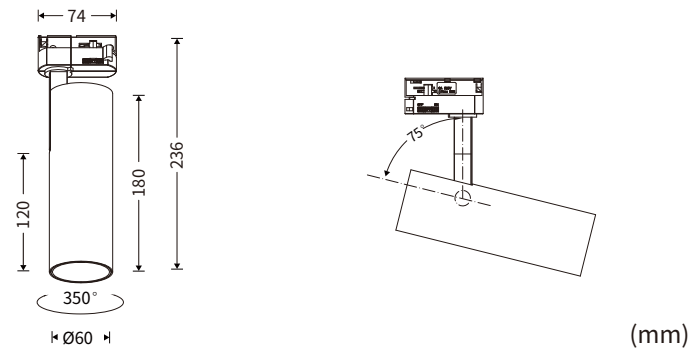

Track Adaptor



Color Finishing

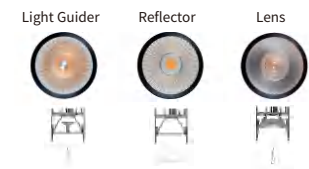

LED & Driver

Philips Lumileds:  
 Power: 12.3W/LED  
 Voltage: 34.5V  
 SDCM<3  
 Driver:  
 Input Voltage:220-240VAC  
 Output Current:350mA  
 Output Voltage:DC20-40V



G.W.:14.85kgs  
 Packaging:45x34x53cm,24PCS/CTN



LED Type PHILIPS IP20 (IP20 for visible body of fitting after installation)  White as standard **Ivy**

Power	CRI	Beam Angle	Luminous Flux	CCT	Track	Frame	Model Number
28W	>90	15°	2550lm	2700K	3 circuit	white	IVY28-W2715T
			2600lm	3000K	3 circuit	black	IVY28-B3015T
			2650lm	4000K	3 circuit	white	IVY28-W4015T
		30°	2550lm	2700K	3 circuit	black	IVY28-B2730T
			2600lm	3000K	3 circuit	white	IVY28-W3030T
			2650lm	4000K	3 circuit	black	IVY28-B4030T
		50°	2550lm	2700K	3 circuit	white	IVY28-W2750T
			2600lm	3000K	3 circuit	black	IVY28-B3050T
			2650lm	4000K	3 circuit	white	IVY28-W4050T

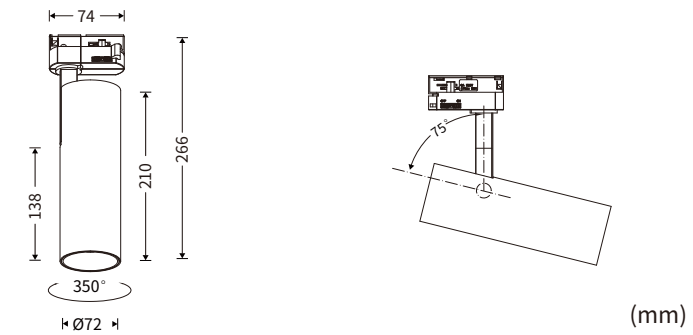

Track Adaptor



Color Finishing

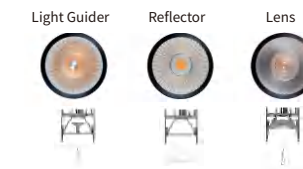

LED & Driver

Philips Lumileds:  
 Power: 25W/LED  
 Voltage: 35V  
 SDCM<3  
 Driver:  
 Input Voltage:220-240VAC  
 Output Current:700mA  
 Output Voltage:DC20-40V



G.W.:21.41kgs  
 Packaging:45x35x60cm,24PCS/CTN

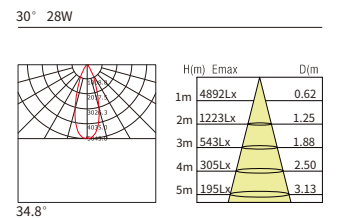
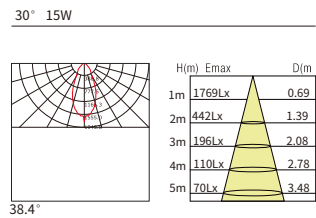







LED Type PHILIPS IP20 for visible body of fitting after installation  White as standard **Ivy**

Power	CRI	Beam Angle	Luminous Flux	CCT	Frame	Model Number
15W	>90	15°	1150lm	2700K	white	IVY15-W2715C
			1200lm	3000K	black	IVY15-B3015C
			1250lm	4000K	white	IVY15-W4015C
		30°	1150lm	2700K	black	IVY15-B2730C
			1200lm	3000K	white	IVY15-W3030C
			1250lm	4000K	black	IVY15-B4030C
		50°	1150lm	2700K	white	IVY15-W2750C
			1200lm	3000K	black	IVY15-B3050C
			1250lm	4000K	white	IVY15-W4050C

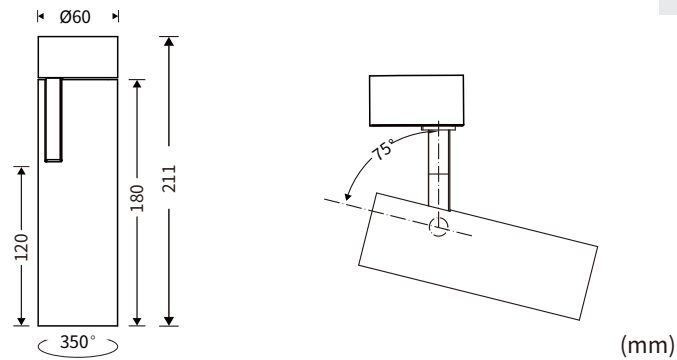

Color Finishing

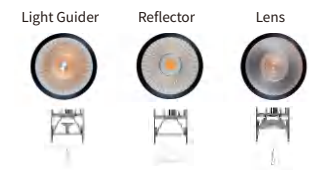

LED & Driver

Philips Lumileds:  
 Power: 12.3W/LED  
 Voltage: 34.5V  
 SDCM<3  
 Driver:  
 Input Voltage:220-240VAC  
 Output Current:350mA  
 Output Voltage:DC20-40V



G.W.:14.85kgs  
 Packaging:45x34x53cm,24PCS/CTN



30° 15W

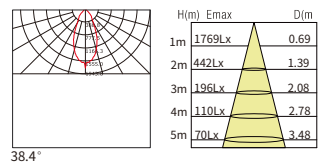

LED Type PHILIPS IP20 for visible body of fitting after installation  White as standard **Ivy**

Power	CRI	Beam Angle	Luminous Flux	CCT	Frame	Model Number
28W	>90	15°	2550lm	2700K	white	IVY28-W2715C
			2600lm	3000K	black	IVY28-B3015C
			2650lm	4000K	white	IVY28-W4015C
		30°	2550lm	2700K	black	IVY28-B2730C
			2600lm	3000K	white	IVY28-W3030C
			2650lm	4000K	black	IVY28-B4030C
		50°	2550lm	2700K	white	IVY28-W2750C
			2600lm	3000K	black	IVY28-B3050C
			2650lm	4000K	white	IVY28-W4050C

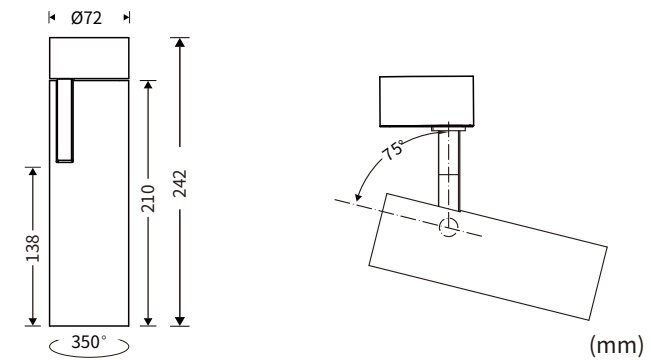

Color Finishing

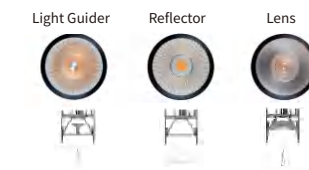

LED & Driver

Philips Lumileds:  
 Power: 25W/LED  
 Voltage: 35V  
 SDCM<3  
 Driver:  
 Input Voltage:220-240VAC  
 Output Current:700mA  
 Output Voltage:DC20-40V



G.W.:21.41kgs  
 Packaging:45x35x60cm,24PCS/CTN



30° 28W

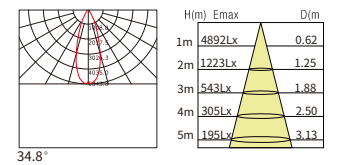





LED Type: PHILIPS  
IP20 for visible body of fitting after installation  
White as standard

Ivy

Power	CRI	Beam Angle	Luminous Flux	CCT	Frame	Model Number
15W	>90	15°	1150lm	2700K	white	IVY15-W2715S
			1200lm	3000K	black	IVY15-B3015S
			1250lm	4000K	white	IVY15-W4015S
		30°	1150lm	2700K	black	IVY15-B2730S
			1200lm	3000K	white	IVY15-W3030S
			1250lm	4000K	black	IVY15-B4030S
		50°	1150lm	2700K	white	IVY15-W2750S
			1200lm	3000K	black	IVY15-B3050S
			1250lm	4000K	white	IVY15-W4050S

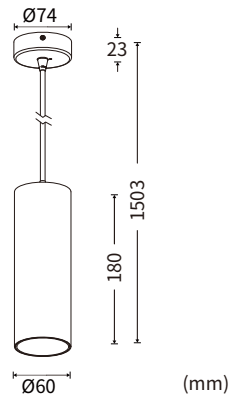

Color Finishing

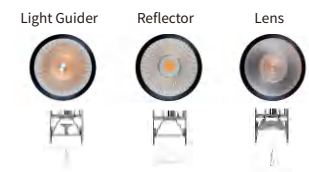

LED & Driver

Philips Lumileds:  
Power: 12.3W/LED  
Voltage: 34.5V  
SDCM<3  
Driver:  
Input Voltage:220-240VAC  
Output Current:350mA  
Output Voltage:DC20-40V



G.W.:14.85kgs  
Packaging:45x34x53cm,24PCS/CTN



30° 15W

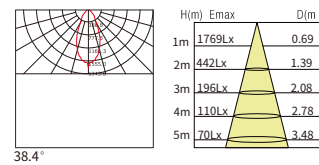

LED Type: PHILIPS  
IP20 for visible body of fitting after installation  
White as standard

Ivy

Power	CRI	Beam Angle	Luminous Flux	CCT	Frame	Model Number
28W	>90	15°	2550lm	2700K	white	IVY28-W2715S
			2600lm	3000K	black	IVY28-B3015S
			2650lm	4000K	white	IVY28-W4015S
		30°	2550lm	2700K	black	IVY28-B2730S
			2600lm	3000K	white	IVY28-W3030S
			2650lm	4000K	black	IVY28-B4030S
		50°	2550lm	2700K	white	IVY28-W2750S
			2600lm	3000K	black	IVY28-B3050S
			2650lm	4000K	white	IVY28-W4050S

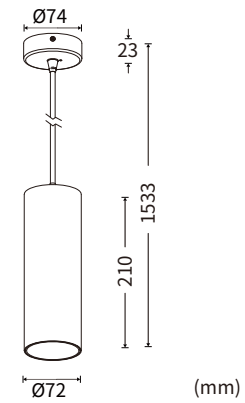

Color Finishing

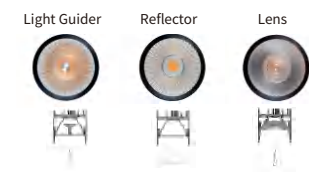

LED & Driver

Philips Lumileds:  
Power: 25W/LED  
Voltage: 35V  
SDCM<3  
Driver:  
Input Voltage:220-240VAC  
Output Current:700mA  
Output Voltage:DC20-40V



G.W.:21.41kgs  
Packaging:45x35x60cm,24PCS/CTN



30° 28W

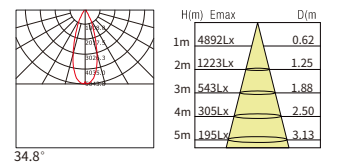



# Stars

Excellent light quality with decorative reflector- that is the speciality of Stars.  
 The LED downlights, which are recessed into the ceiling,  
 are perfect for uniform and glare-free lighting in shops and offices.

LED Type: CREE  
 IP20

○ White color as standard

Power	CRI	Beam Angle	Luminous Flux	CCT	Housing	Model Number
15W	>90	18°	1350lm	2700K	white	STARS15-W2718
			1460lm	3000K	white	STARS15-W3018
			1520lm	4000K	white	STARS15-W4018
		24°	1350lm	2700K	white	STARS15-W2724
			1460lm	3000K	white	STARS15-W3024
			1520lm	4000K	white	STARS15-W4024
		36°	1350lm	2700K	white	STARS15-W2736
			1460lm	3000K	white	STARS15-W3036
			1520lm	4000K	white	STARS15-W4036

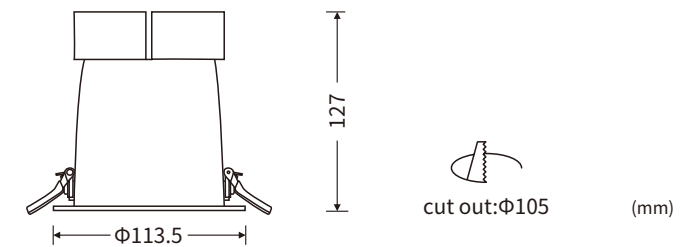

### LED & Driver

CREE COB:  
 Power: 15W/LED  
 Voltage: 36V  
 SDCM<5  
 LIFUD driver:  
 Input voltage:100-240VAC  
 /220-240V/110-130V  
 Output current:300mA  
 Output voltage:DC24-40V



### 36° 15W

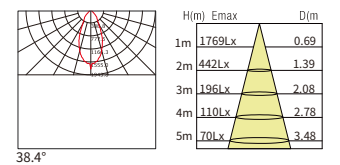



LED Type: CREE IP20  White color as standard **Stars**

Power	CRI	Beam Angle	Luminous Flux	CCT	Housing	Model Number
30W	>90	18°	2700lm	2700K	white	STARS30-W2718
			2760lm	3000K	white	STARS30-W3018
			2820lm	4000K	white	STARS30-W4018
		24°	2700lm	2700K	white	STARS30-W2724
			2760lm	3000K	white	STARS30-W3024
			2820lm	4000K	white	STARS30-W4024
		36°	2700lm	2700K	white	STARS30-W2736
			2760lm	3000K	white	STARS30-W3036
			2820lm	4000K	white	STARS30-W4036

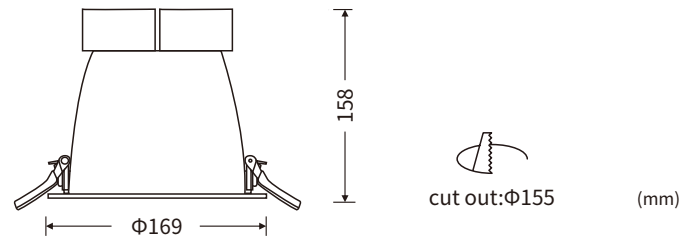

**LED & Driver**

CREE COB:  
 Power: 30W/LED  
 Voltage: 36V  
 SDCM<5  
 LIFUD driver:  
 Input voltage:100-240VAC  
 /220-240V/110-130V  
 Output current:700mA  
 Output voltage:DC24-54V

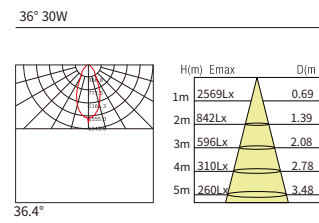

LED Type: CREE IP20  White color as standard **Stars**

Power	CRI	Beam Angle	Luminous Flux	CCT	Housing	Model Number
45W	>90	18°	4050lm	2700K	white	STARS45-W2718
			4100lm	3000K	white	STARS45-W3018
			4150lm	4000K	white	STARS45-W4018
			4050lm	2700K	white	STARS45-W2724
			4100lm	3000K	white	STARS45-W3024
			4150lm	4000K	white	STARS45-W4024
		24°	4050lm	2700K	white	STARS45-W2724
			4100lm	3000K	white	STARS45-W3024
			4150lm	4000K	white	STARS45-W4024
			4050lm	2700K	white	STARS45-W2736
			4100lm	3000K	white	STARS45-W3036
			4150lm	4000K	white	STARS45-W4036
		36°	4050lm	2700K	white	STARS45-W2736
			4100lm	3000K	white	STARS45-W3036
			4150lm	4000K	white	STARS45-W4036

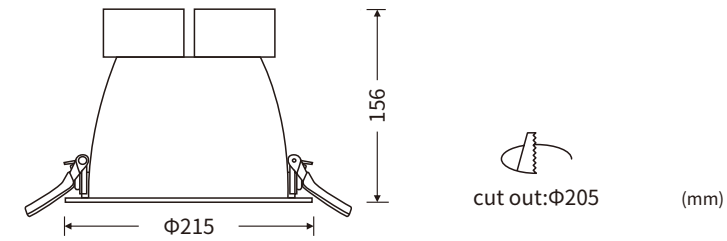

**LED & Driver**

CREE COB:  
 Power: 45W/LED  
 Voltage: 36V  
 SDCM<5  
 LIFUD driver:  
 Input voltage:100-240VAC  
 /220-240V/110-130V  
 Output current:900mA  
 Output voltage:DC30-60V

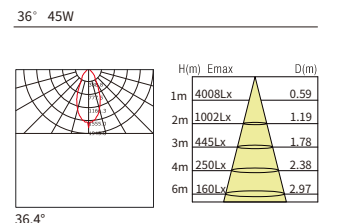



# Super Bowl





# SUPER BOWL SUPER COMFORT



The ultimate soft light



LED Type PHILIPS IP20  White color as standard **Super bowl**

Power	CRI	Beam Angle	Luminous Flux	CCT	Housing	Model Number
8W	>90	15°	640lm	2700K	white	SUB08-W2715
			660lm	3000K	white	SUB08-W3015
			700lm	4000K	white	SUB08-W4015
		24°	650lm	2700K	white	SUB08-W2724
			670lm	3000K	white	SUB08-W3024
			710lm	4000K	white	SUB08-W4024
		36°	640lm	2700K	white	SUB08-W2736
			670lm	3000K	white	SUB08-W3036
			700lm	4000K	white	SUB08-W4036
		60°	640lm	2700K	white	SUB08-W2760
			670lm	3000K	white	SUB08-W3060
			700lm	4000K	white	SUB08-W4060

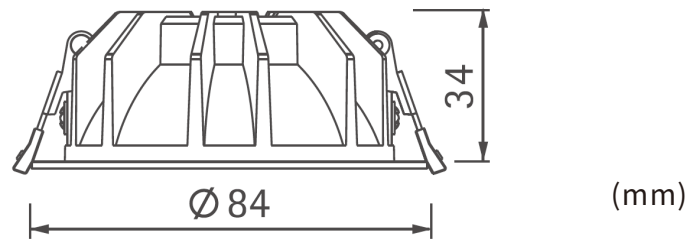
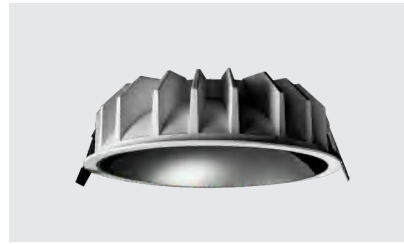

**LED & Driver**

CREE COB:  
 Power: 8W/LED  
 Voltage: 36V  
 SDCM < 6  
 LIFUD driver:  
 Input voltage: 110-270VAC  
 220-240VAC  
 Output current: 200mA  
 Output voltage: DC24-40V



8W 36°

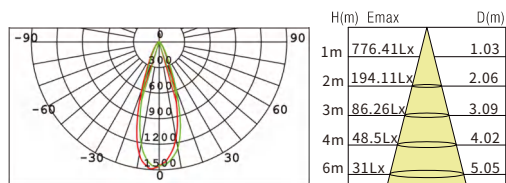

LED Type PHILIPS IP20  White color as standard **Super bowl**

Power	CRI	Beam Angle	Luminous Flux	CCT	Housing	Model Number
15W	>90	15°	1200lm	2700K	white	SUB15-W2715
			1250lm	3000K	white	SUB15-W3015
			1300lm	4000K	white	SUB15-W4015
		24°	1200lm	2700K	white	SUB15-W2724
			1250lm	3000K	white	SUB15-W3024
			1300lm	4000K	white	SUB15-W4024
		36°	1200lm	2700K	white	SUB15-W2736
			1250lm	3000K	white	SUB15-W3036
			1300lm	4000K	white	SUB15-W4036
		60°	1200lm	2700K	white	SUB15-W2760
			1250lm	3000K	white	SUB15-W3060
			1300lm	4000K	white	SUB15-W4060

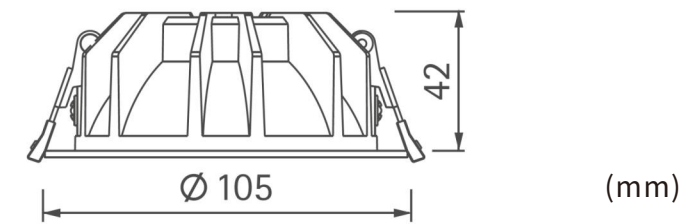

**LED & Driver**

CREE COB:  
 Power: 17W/LED  
 Voltage: 36V  
 SDCM < 6  
 LIFUD driver:  
 Input voltage: 110-270VAC  
 220-240VAC  
 Output current: 350mA  
 Output voltage: DC24-40V



15W 60°

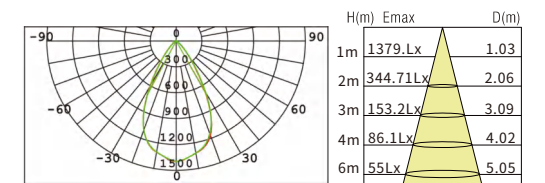

LED Type PHILIPS IP20  White color as standard **Super bowl**

Power	CRI	Beam Angle	Luminous Flux	CCT	Housing	Model Number
20W	>90	15°	1600lm	2700K	white	SUB20-W2715
			1650lm	3000K	white	SUB20-W3015
			1700lm	4000K	white	SUB20-W4015
		24°	1600lm	2700K	white	SUB20-W2724
			1650lm	3000K	white	SUB20-W3024
			1700lm	4000K	white	SUB20-W4024
		36°	1600lm	2700K	white	SUB20-W2736
			1650lm	3000K	white	SUB20-W3036
			1700lm	4000K	white	SUB20-W4036
		60°	1600lm	2700K	white	SUB20-W2760
			1650lm	3000K	white	SUB20-W3060
			1700lm	4000K	white	SUB20-W4060

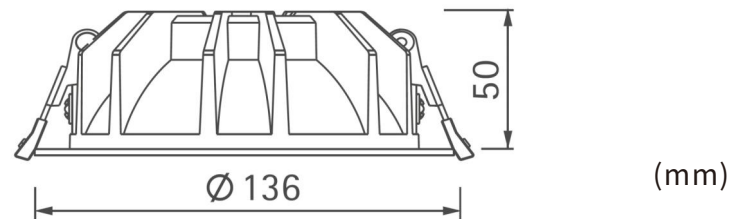

20W 60°

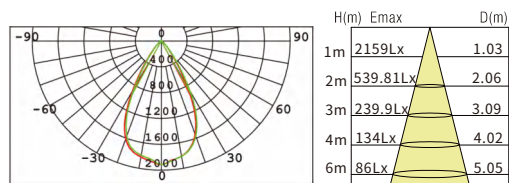

LED & Driver

CREE COB:  
 Power: 22W/LED  
 Voltage: 36V  
 SDCM < 6  
 LIFUD driver:  
 Input voltage: 110-270VAC  
 220-240VAC  
 Output current: 500mA  
 Output voltage: DC24-40V



LED Type CREE IP20  White color as standard **Super bowl**

Power	CRI	Beam Angle	Luminous Flux	CCT	Housing	Model Number
30W	>90	15°	2400lm	2700K	white	SUB30-W2715
			2450lm	3000K	white	SUB30-W3015
			2500lm	4000K	white	SUB30-W4015
		24°	2400lm	2700K	white	SUB30-W2724
			2450lm	3000K	white	SUB30-W3024
			2500lm	4000K	white	SUB30-W4024
		36°	2400lm	2700K	white	SUB30-W2736
			2450lm	3000K	white	SUB30-W3036
			2500lm	4000K	white	SUB30-W4036
		60°	2400lm	2700K	white	SUB30-W2760
			2450lm	3000K	white	SUB30-W3060
			2500lm	4000K	white	SUB30-W4060

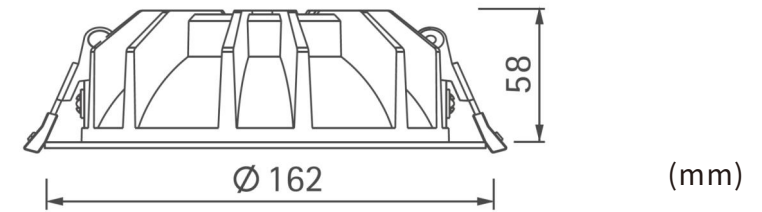

30W 60°

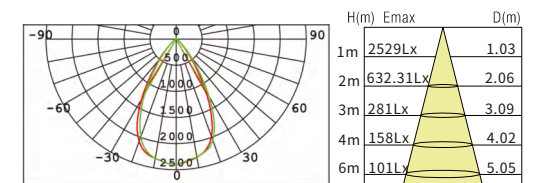

LED & Driver

CREE COB:  
 Power: 32W/LED  
 Voltage: 36V  
 SDCM < 6  
 LIFUD driver:  
 Input voltage: 110-270VAC  
 220-240VAC  
 Output current: 700mA  
 Output voltage: DC24-40V





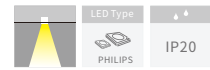

○ White color as standard

## Super bowl

Power	CRI	Beam Angle	Luminous Flux	CCT	Housing	Model Number
40W	>90	15°	3200lm	2700K	white	SUB40-W2715
			3250lm	3000K	white	SUB40-W3015
			3300lm	4000K	white	SUB40-W4015
		24°	3200lm	2700K	white	SUB40-W2724
			3250lm	3000K	white	SUB40-W3024
			3300lm	4000K	white	SUB40-W4024
		36°	3200lm	2700K	white	SUB40-W2736
			3250lm	3000K	white	SUB40-W3036
			3300lm	4000K	white	SUB40-W4036
60°	3200lm	2700K	white	SUB40-W2760		
	3250lm	3000K	white	SUB40-W3060		
	3300lm	4000K	white	SUB40-W4060		

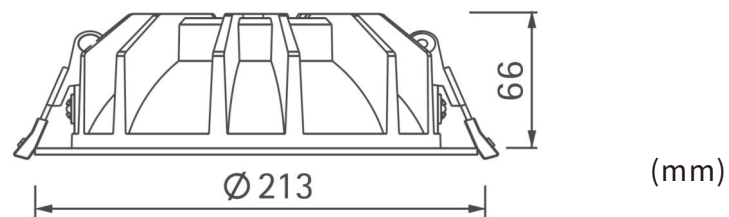

### LED & Driver

**CREE COB:**  
 Power: 42W/LED  
 Voltage: 36V  
 SDCM < 6  
**LIFUD driver:**  
 Input voltage: 110-270VAC  
 220-240VAC  
 Output current: 1050mA  
 Output voltage: DC24-40V



40W 36°

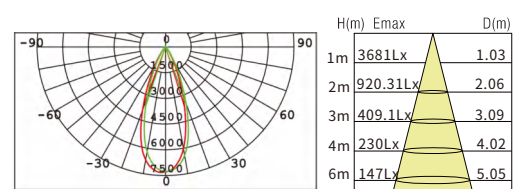



## UGR down light

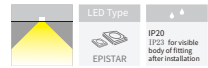

White housing+silver inside as standard

Power	CRI	Beam Angle	Luminous Flux	CCT	Refractive screen	Frame	Model Number
5W	>85	80°	425lm	3000K	white	white	UGR05-WW30
			450lm	4000K	black	white	UGR05-WB40
10W			800lm	3000K	silver	white	UGR10-WS30
			900lm	4000K	red	white	UGR10-WR40
15W			1200lm	3000K	golden	white	UGR15-WG30
			1300lm	4000K	silver	white	UGR15-WS40
20W			1600lm	3000K	silver	white	UGR20-WS30
			1700lm	4000K	silver	white	UGR20-WS40
30W			2400lm	3000K	silver	white	UGR30-WS30
			2500lm	4000K	silver	white	UGR30-WS40

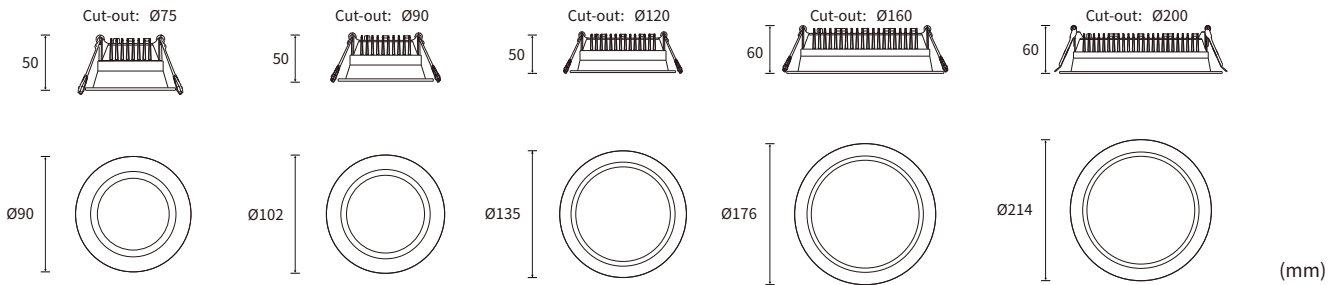

### Optional



### LED & Driver

**EPSTAR smd2835:**  
 Power: 0.2W/LED  
 Voltage: 3V  
 SDCM<6  
 Driver:  
 Input Voltage:220-240VAC  
 Output:  
 5W-6B5C-30LEDS-300mA-15V  
 10W-6B10C-60LEDS-300mA-30V  
 15W-6B12C-72LEDS-300mA-36V  
 20W-6B20C-120LEDS-500mA-36V  
 30W-6B30C-180LEDS-750mA-36V



5W G.W.:10.20kgs  
 Packaging:57x36x40cm,50PCS/CTN  
 10W G.W.:13.10kgs  
 Packaging:57x36x40cm,50PCS/CTN  
 15W G.W.:11.64kgs  
 Packaging:45x42x40cm,30PCS/CTN  
 20W G.W.:12.82kgs  
 Packaging:52x40x40cm,20PCS/CTN  
 30W G.W.:12.82kgs  
 Packaging:52x40x40cm,20PCS/CTN

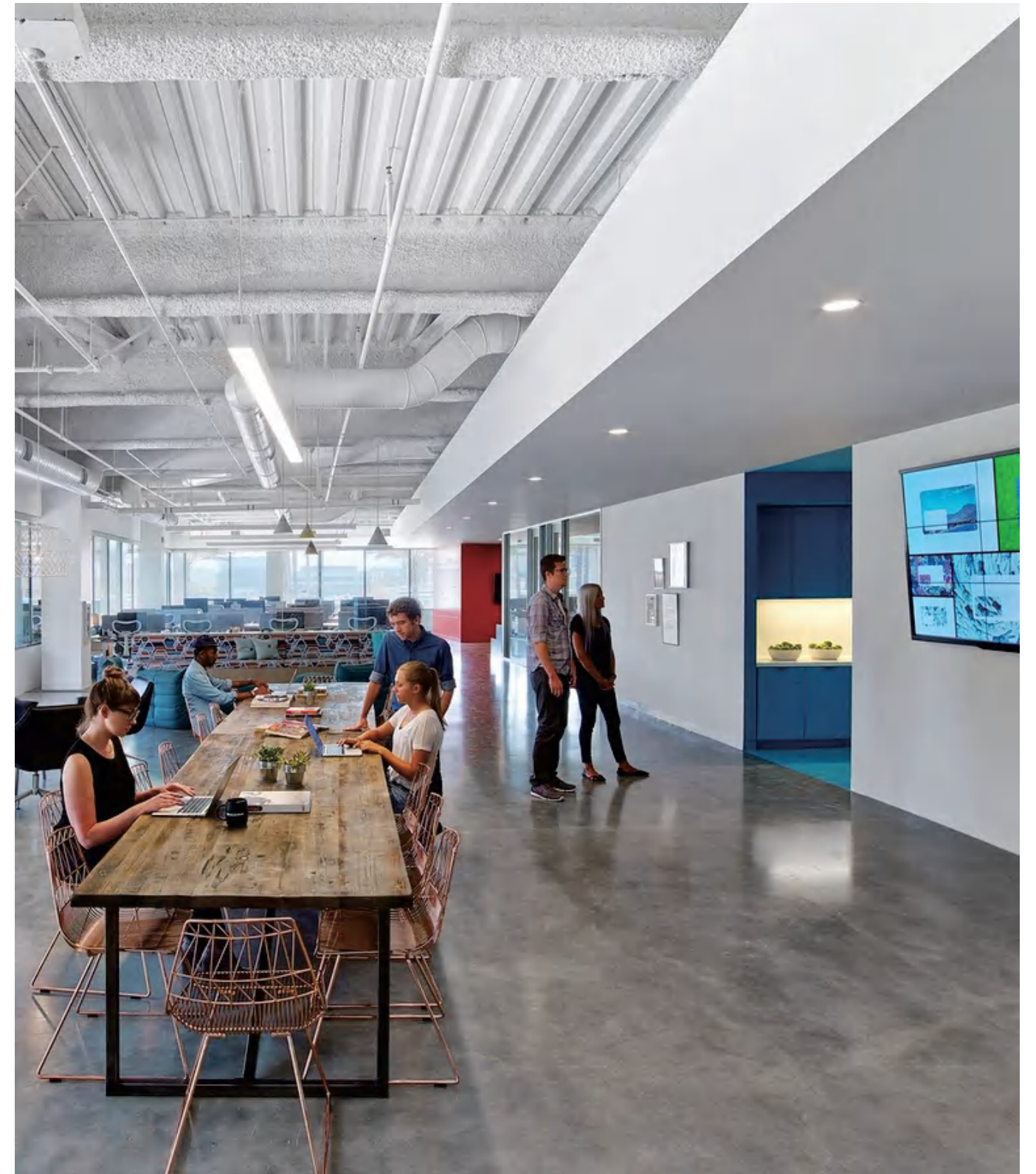
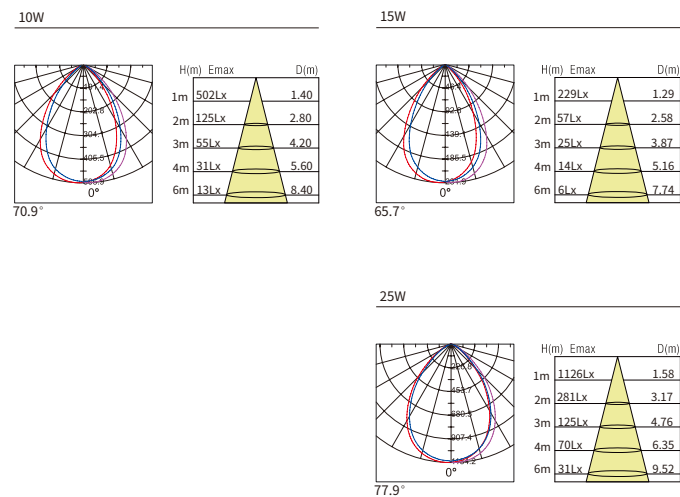

LED Type  
EPistar

IP20  
IP20: for visible body of fitting after installation

○ White color as standard

## Libra

Power CRI Beam Angle Luminous Flux CCT Body Frame Model Number

Power	CRI	Beam Angle	Luminous Flux	CCT	Body	Frame	Model Number
10W	>80	90°	800lm	3000K	black	white	LIBRA10-W30R
			850lm	4000K	black	white	LIBRA10-W40R
			900lm	6000K	black	white	LIBRA10-W60R
15W	>80	90°	1200lm	3000K	black	white	LIBRA10-W30S
			1275lm	4000K	black	white	LIBRA10-W40S
			1350lm	6000K	black	white	LIBRA10-W60S
20W	>80	90°	1600lm	3000K	black	white	LIBRA10-W30R
			1700lm	4000K	black	white	LIBRA10-W40R
			1800lm	6000K	black	white	LIBRA10-W60R

LED Type  
EPistar

IP20  
IP20: for visible body of fitting after installation

○ White color as standard

## Libra

Power CRI Beam Angle Luminous Flux CCT Body Frame Model Number

Power	CRI	Beam Angle	Luminous Flux	CCT	Body	Frame	Model Number
10W	>80	90°	800lm	3000K	black	white	LIBRA10-W30S
			850lm	4000K	black	white	LIBRA10-W40S
			900lm	6000K	black	white	LIBRA10-W60S
15W	>80	90°	1200lm	3000K	black	white	LIBRA10-W30S
			1275lm	4000K	black	white	LIBRA10-W40S
			1350lm	6000K	black	white	LIBRA10-W60S
20W	>80	90°	1600lm	3000K	black	white	LIBRA10-W30S
			1700lm	4000K	black	white	LIBRA10-W40S
			1800lm	6000K	black	white	LIBRA10-W60S

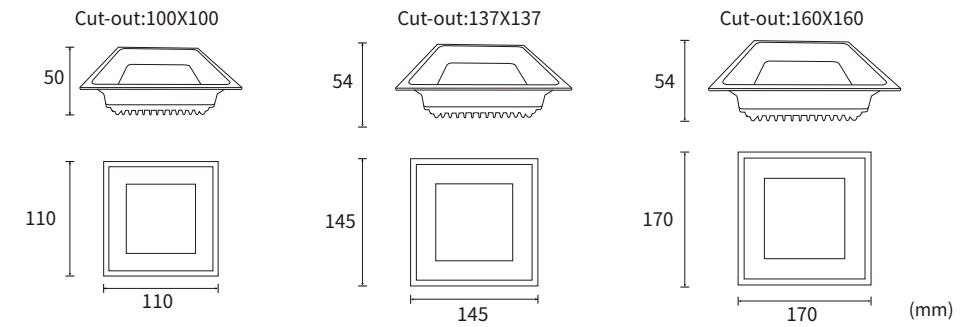
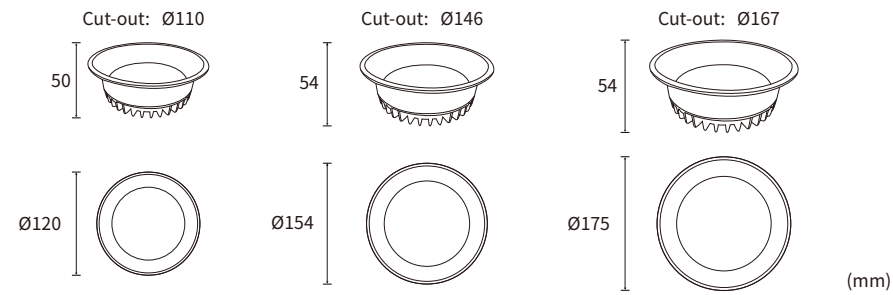

### Reflector Cover

(standard)  
PC diffuser

### LED & Driver

Epistar smd2835:  
Power: 0.2W/LED  
Voltage: 3-3.1V  
SDCM<6  
Driver:  
Input Voltage:100-240VAC  
Output:  
10W-5B10C-50LEDS-300mA/24-48V  
15W-5B15C-75LEDS-300mA/36-72V  
20W-5B20C-100LEDS-300mA/54-100V



10W G.W.:8.20kgs  
Packaging:49.5x27x27cm,15PCS/CTN  
15W G.W.:11.00kgs  
Packaging:44.5x33x34cm,10PCS/CTN  
20W G.W.:10.30kgs  
Packaging:59x42x21cm,10PCS/CTN

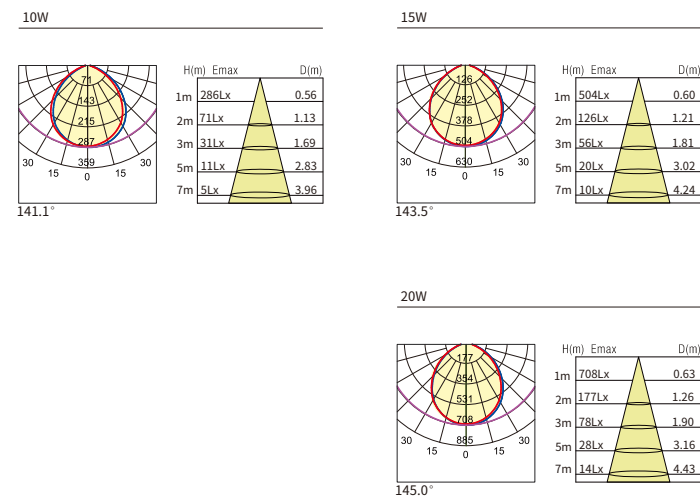

### Reflector Cover

(standard)  
PC diffuser

### LED & Driver

Epistar smd2835:  
Power: 0.2W/LED  
Voltage: 3-3.1V  
SDCM<6  
Driver:  
Input Voltage:100-240VAC  
Output:  
10W-5B10C-50LEDS-300mA/24-48V  
15W-5B15C-75LEDS-300mA/36-72V  
20W-5B20C-100LEDS-300mA/54-100V



10W G.W.:8.20kgs  
Packaging:49.5x27x27cm,15PCS/CTN  
15W G.W.:11.20kgs  
Packaging:44.5x33x34cm,10PCS/CTN  
20W G.W.:11.30kgs  
Packaging:59x42x21cm,10PCS/CTN

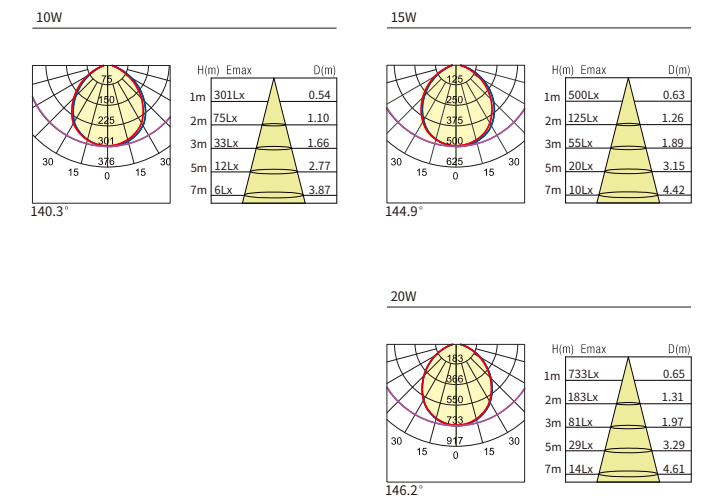



LED Type: Epistar, IP20, for visible body of fitting after installation. White color as standard. Coin

Power	CRI	Beam Angle	Luminous Flux	CCT	LGP	Frame	Model Number
6W	>80	100°	450lm	3000K	acrylic	white	COIN06-W30R
			480lm	4000K	acrylic	black	COIN06-W40R
			510lm	6000K	acrylic	white	COIN06-W60R
12W	>80	100°	900lm	3000K	acrylic	black	COIN12-W30R
			960lm	4000K	acrylic	white	COIN12-W40R
			1020lm	6000K	acrylic	black	COIN12-W60R
18W	>80	100°	1350lm	3000K	acrylic	white	COIN18-W30R
			1440lm	4000K	acrylic	black	COIN18-W40R
			1530lm	6000K	acrylic	white	COIN18-W60R
24W	>80	100°	1800lm	3000K	acrylic	black	COIN24-W30R
			1920lm	4000K	acrylic	white	COIN24-W40R
			2040lm	6000K	acrylic	black	COIN24-W60R

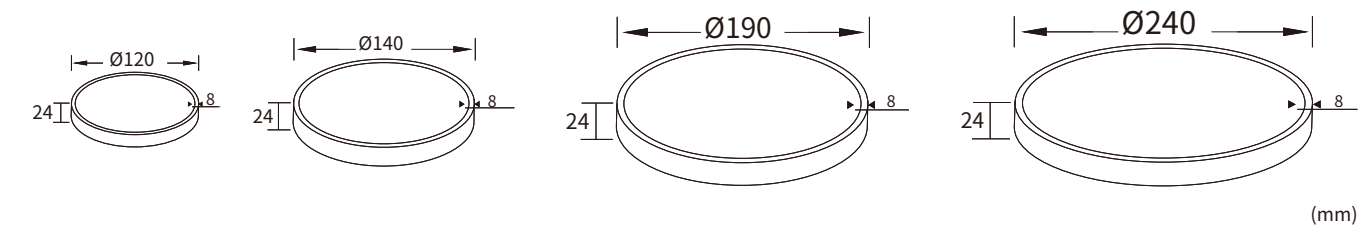

Installation

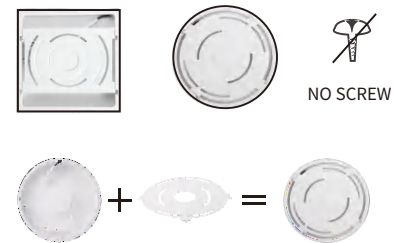

LED & Driver

Epistar smd2835:  
 Power: 0.2W/LED  
 Voltage: 3-3.1V  
 SDCM<6  
 Driver:  
 Input Voltage:100-240VAC  
 Output:  
 6W-5B6C-30LEDS-300mA/12-28V  
 12W-5B12C-60LEDS-300mA/24-48V  
 18W-5B18C-90LEDS-300mA/36-72V  
 24W-5B24C-120LEDS-300mA/54-100V

6W G.W.:8.70kgs  
 Packaging:57x35x13cm,50PCS/CTN  
 12W G.W.:6.70kgs  
 Packaging:34x35x18cm,20PCS/CTN  
 18W G.W.:11.30kgs  
 Packaging:42x34.7x24cm,20PCS/CTN  
 24W G.W.:9.10kgs  
 Packaging:35x28x27cm,10PCS/CTN

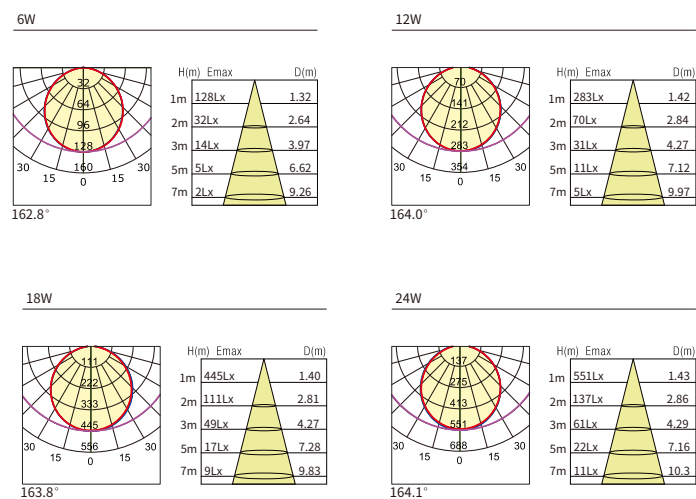

LED Type: Epistar, IP20, for visible body of fitting after installation. White color as standard. Coin

Power	CRI	Beam Angle	Luminous Flux	CCT	LGP	Frame	Model Number
6W	>80	100°	450lm	3000K	acrylic	white	COIN06-W30S
			480lm	4000K	acrylic	black	COIN06-W40S
			510lm	6000K	acrylic	white	COIN06-W60S
12W	>80	100°	900lm	3000K	acrylic	black	COIN12-W30S
			960lm	4000K	acrylic	white	COIN12-W40S
			1020lm	6000K	acrylic	black	COIN12-W60S
18W	>80	100°	1350lm	3000K	acrylic	white	COIN18-W30S
			1440lm	4000K	acrylic	black	COIN18-W40S
			1530lm	6000K	acrylic	white	COIN18-W60S
24W	>80	100°	1800lm	3000K	acrylic	black	COIN24-W30S
			1920lm	4000K	acrylic	white	COIN24-W40S
			2040lm	6000K	acrylic	black	COIN24-W60S

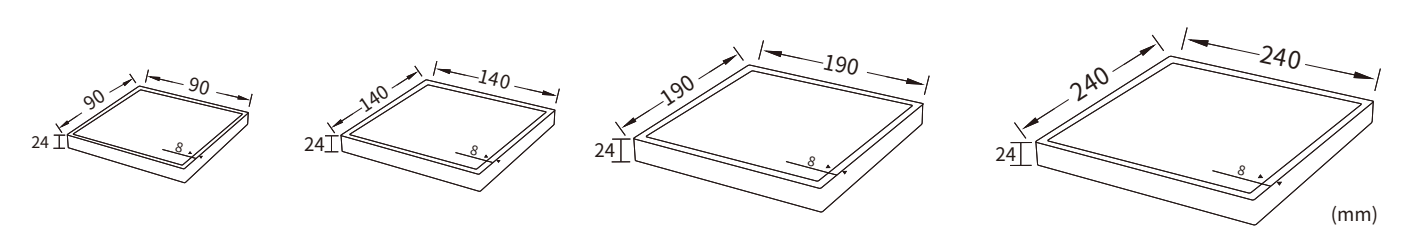

Installation

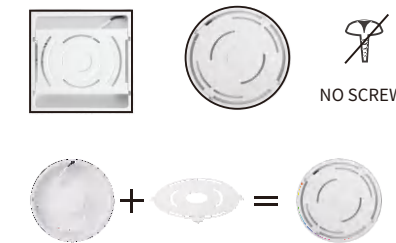

LED & Driver

Epistar smd2835:  
 Power: 0.2W/LED  
 Voltage: 3-3.1V  
 SDCM<6  
 Driver:  
 Input Voltage:100-240VAC  
 Output:  
 6W-5B6C-30LEDS-300mA/12-28V  
 12W-5B12C-60LEDS-300mA/24-48V  
 18W-5B18C-90LEDS-300mA/36-72V  
 24W-5B24C-120LEDS-300mA/54-100V

6W G.W.:10.00kgs  
 Packaging:57x35x13cm,50PCS/CTN  
 12W G.W.:7.60kgs  
 Packaging:34x35x18cm,20PCS/CTN  
 18W G.W.:13.00kgs  
 Packaging:42x34.7x24cm,20PCS/CTN  
 24W G.W.:10.10kgs  
 Packaging:35x28x27cm,10PCS/CTN

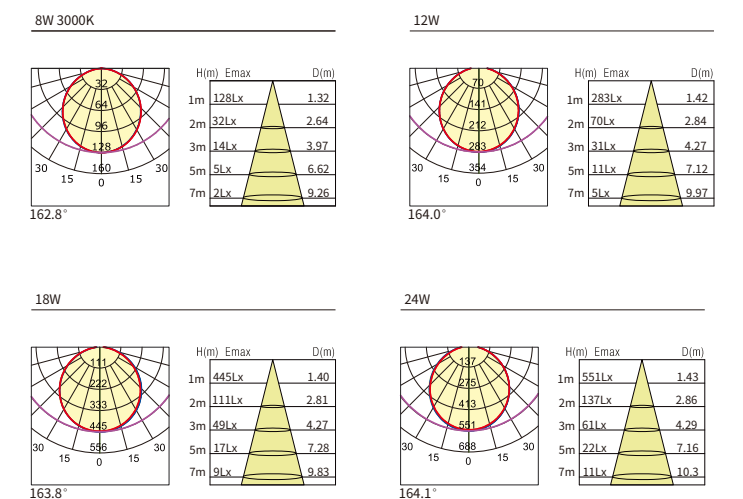



Panel light Interior Ceiling Mounted

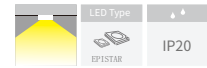

○ White color as standard

### Coin Plus

Power	CRI	Beam Angle	Luminous Flux	CCT	Diffuser	Housing	Model Number
30W	>80	100°	2400lm	3000K	PC	white	CP300-W30
			2550lm	4000K	PC	black	CP300-B40
			2700lm	6000K	PC	white	CP300-W60
40W	>80	100°	3200lm	3000K	PC	black	CP400-B30
			3400lm	4000K	PC	white	CP400-W40
			3600lm	6000K	PC	black	CP400-B60

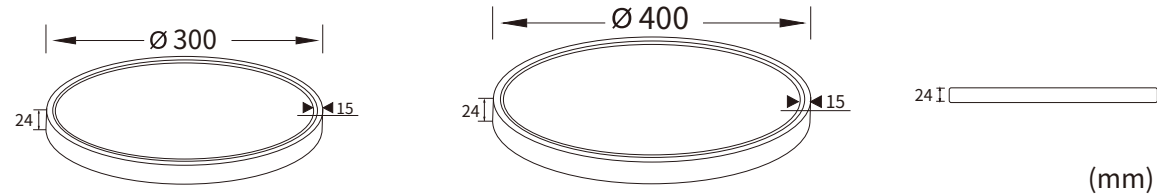

#### Accessory

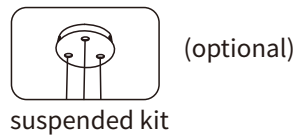

#### LED & Driver

Epistar smd2835:  
 Power: 0.2W/LED  
 Voltage: 3-3.1V  
 SDCM<6  
 Driver:  
 Input Voltage:100-240VAC  
 Output:  
 6W-5B6C-30LEDS-300mA/12-28V  
 12W-5B12C-60LEDS-300mA/24-48V



6W G.W.:8.70kgs  
 Packaging:57x35x13cm,50PCS/CTN  
 12W G.W.:6.70kgs  
 Packaging:34x35x18cm,20PCS/CTN



#### Installation

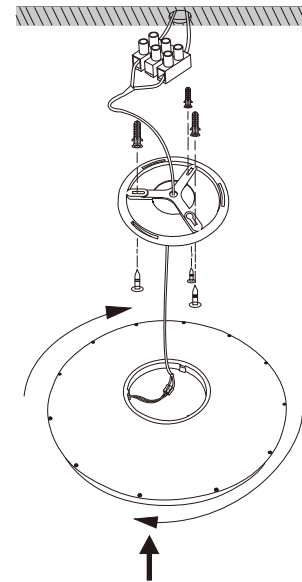

LED Type: EPistar, IP20 (IP20 for visible body of fitting after installation), White color as standard, AMG

Power	CRI	Beam Angle	Luminous Flux	CCT	LGP	Frame	Model Number
8W	>80	100°	640lm	3000K	acrylic	white	AMG08-W30R
			680lm	4000K	acrylic	black	AMG08-W40R
			720lm	6000K	acrylic	white	AMG08-W60R
15W	>80	100°	1200lm	3000K	acrylic	black	AMG15-W30R
			1275lm	4000K	acrylic	white	AMG15-W40R
			1350lm	6000K	acrylic	black	AMG15-W60R
22W	>80	100°	1760lm	3000K	acrylic	white	AMG22-W30R
			1870lm	4000K	acrylic	black	AMG22-W40R
			1980lm	6000K	acrylic	white	AMG22-W60R
26W	>80	100°	2080lm	3000K	acrylic	black	AMG26-W30R
			2210lm	4000K	acrylic	white	AMG26-W40R
			2340lm	6000K	acrylic	black	AMG26-W60R

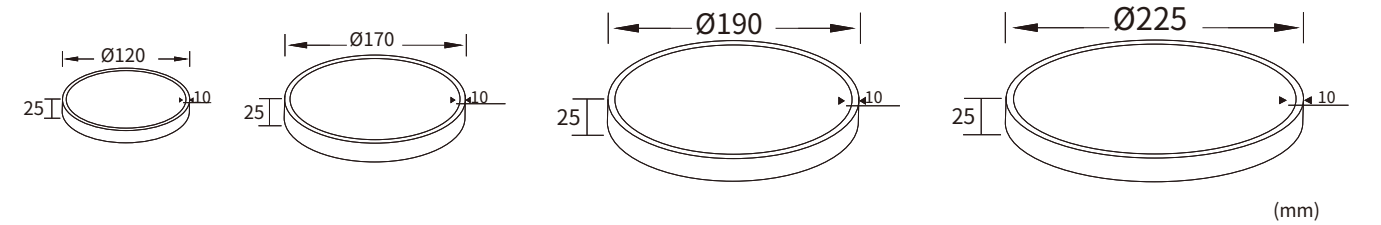

Installation

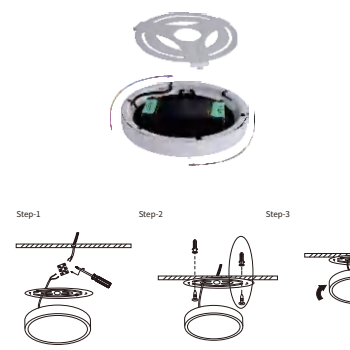

LED & Driver

Osram smd2835:  
 Power: 0.2W/LED  
 Voltage: 3-3.1V  
 SDCM<6  
 Driver:  
 Input Voltage:100-277VAC  
 Output:  
 8W-3B12C-240mA-36V  
 15W-3B20C-240mA-60V  
 22W-4B22C-300mA-66V  
 26W-4B26C-300mA-78V

8W G.W.:7.00kgs  
 Packaging:34x29x16cm,20PCS/CTN  
 15W G.W.:12.50kgs  
 Packaging:39x34x21cm,20PCS/CTN



LED Type: EPistar, IP20 (IP20 for visible body of fitting after installation), White color as standard, AMG

Power	CRI	Beam Angle	Luminous Flux	CCT	LGP	Frame	Model Number
8W	>80	100°	640lm	3000K	acrylic	white	AMG08-W30S
			680lm	4000K	acrylic	black	AMG08-W40S
			720lm	6000K	acrylic	white	AMG08-W60S
15W	>80	100°	1200lm	3000K	acrylic	black	AMG15-W30S
			1275lm	4000K	acrylic	white	AMG15-W40S
			1350lm	6000K	acrylic	black	AMG15-W60S
22W	>80	100°	1760lm	3000K	acrylic	white	AMG22-W30S
			1870lm	4000K	acrylic	black	AMG22-W40S
			1980lm	6000K	acrylic	white	AMG22-W60S
26W	>80	100°	2080lm	3000K	acrylic	black	AMG26-W30S
			2210lm	4000K	acrylic	white	AMG26-W40S
			2340lm	6000K	acrylic	black	AMG26-W60S

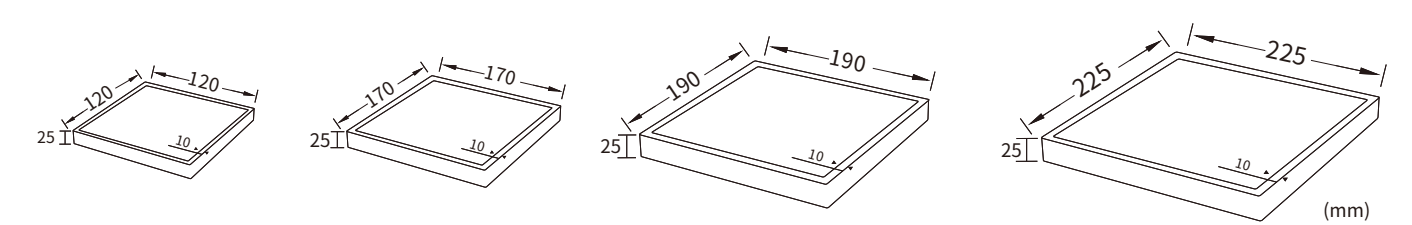

Installation

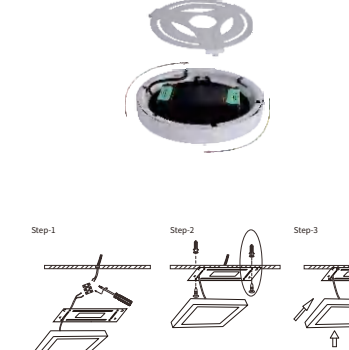

LED & Driver

Osram smd2835:  
 Power: 0.2W/LED  
 Voltage: 3-3.1V  
 SDCM<6  
 Driver:  
 Input Voltage:100-277VAC  
 Output:  
 8W-3B12C-240mA-36V  
 15W-3B20C-240mA-60V  
 22W-4B22C-300mA-66V  
 26W-4B26C-300mA-78V

8W G.W.:7.50kgs  
 Packaging:34x29x16cm,20PCS/CTN  
 15W G.W.:13.50kgs  
 Packaging:39x34x21cm,20PCS/CTN





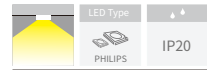

○ White as standard

## Bing

Power	CRI	Beam Angle	Luminous Flux	CCT	Diffuser	Frame	Model Number
12W	>80	100°	960lm	2700K	PC	white	BING12-W27
			980lm	3000K	PC	black	BING12-W30
			1000lm	4000K	PC	white	BING12-W40
24W	>80	100°	1900lm	2700K	PC	black	BING24-W27
			1950lm	3000K	PC	white	BING24-W30
			2000lm	4000K	PC	black	BING24-W40
30W	>80	100°	2400lm	2700K	PC	white	BING30-W27
			2450lm	3000K	PC	black	BING30-W30
			2500lm	4000K	PC	white	BING30-W40
36W	>80	100°	2880lm	2700K	PC	black	BING36-W27
			3000lm	3000K	PC	white	BING36-W30
			3200lm	4000K	PC	black	BING36-W40

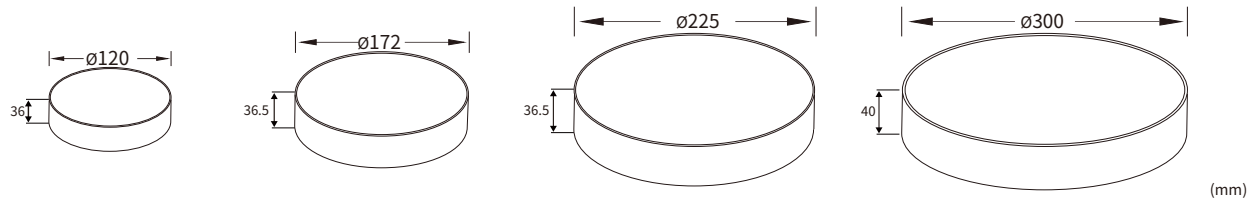

### Reflector Cover

○ (standard)  
PC diffuser

### LED & Driver

EPistar smd:  
Power: 0.2W/LED  
Voltage: 3-3.1V  
SDCM<6  
Driver:  
Input Voltage:220-240VAC  
Output:  
12W-5B20C-600mA/60V  
24W-9B20C-600mA/60V  
30W-12B20C-600mA/60V  
36W-15B25C-600mA/75V



12W G.W.:18.00kgs  
Packaging:56x25x40cm,50PCS/CTN  
24W G.W.:18.00kgs  
Packaging:56x25x40cm,30PCS/CTN  
30W G.W.:16.50kgs  
Packaging:49x25x49cm,20PCS/CTN  
36W G.W.:15.50kgs  
Packaging:48x32.5x35cm,10PCS/CTN

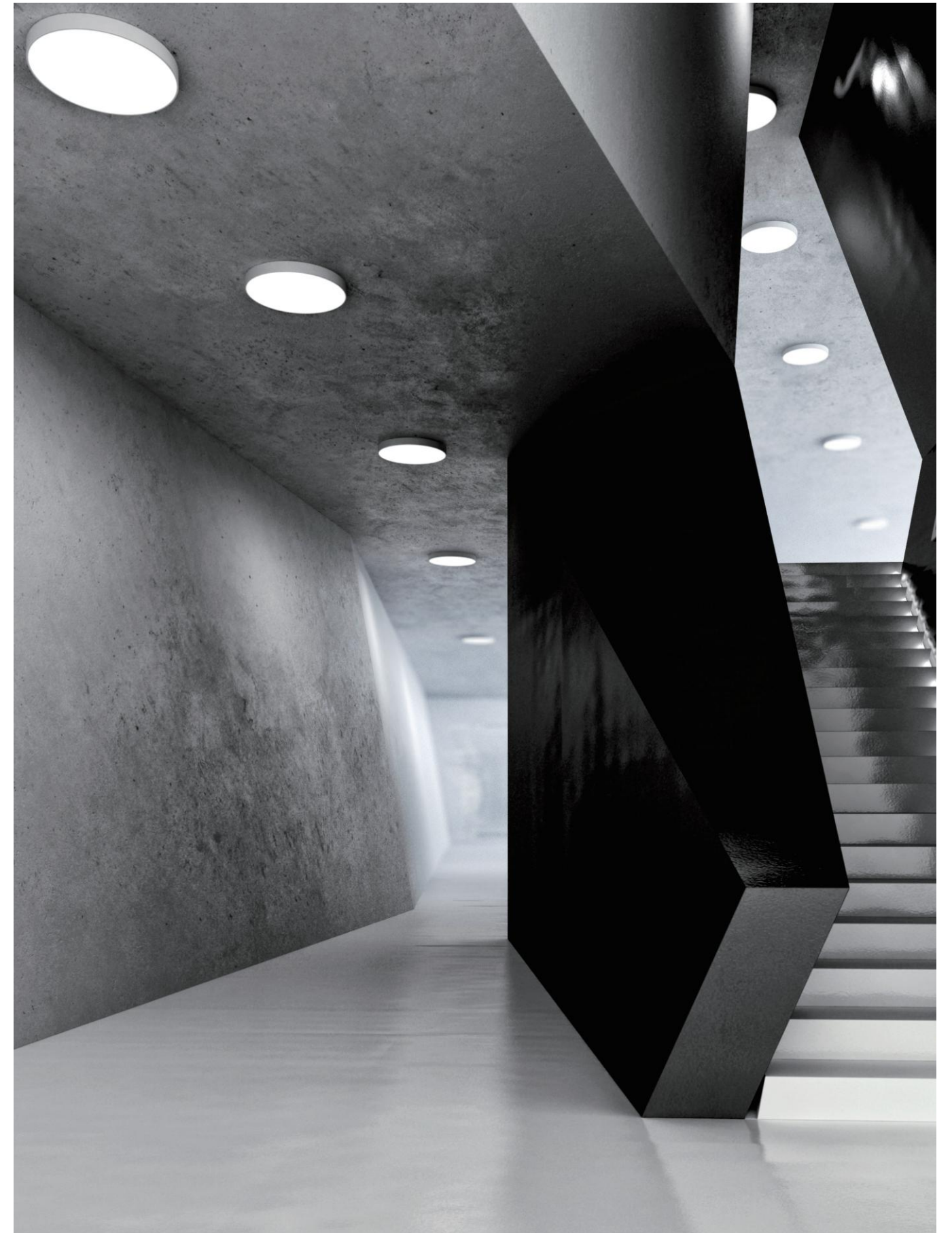



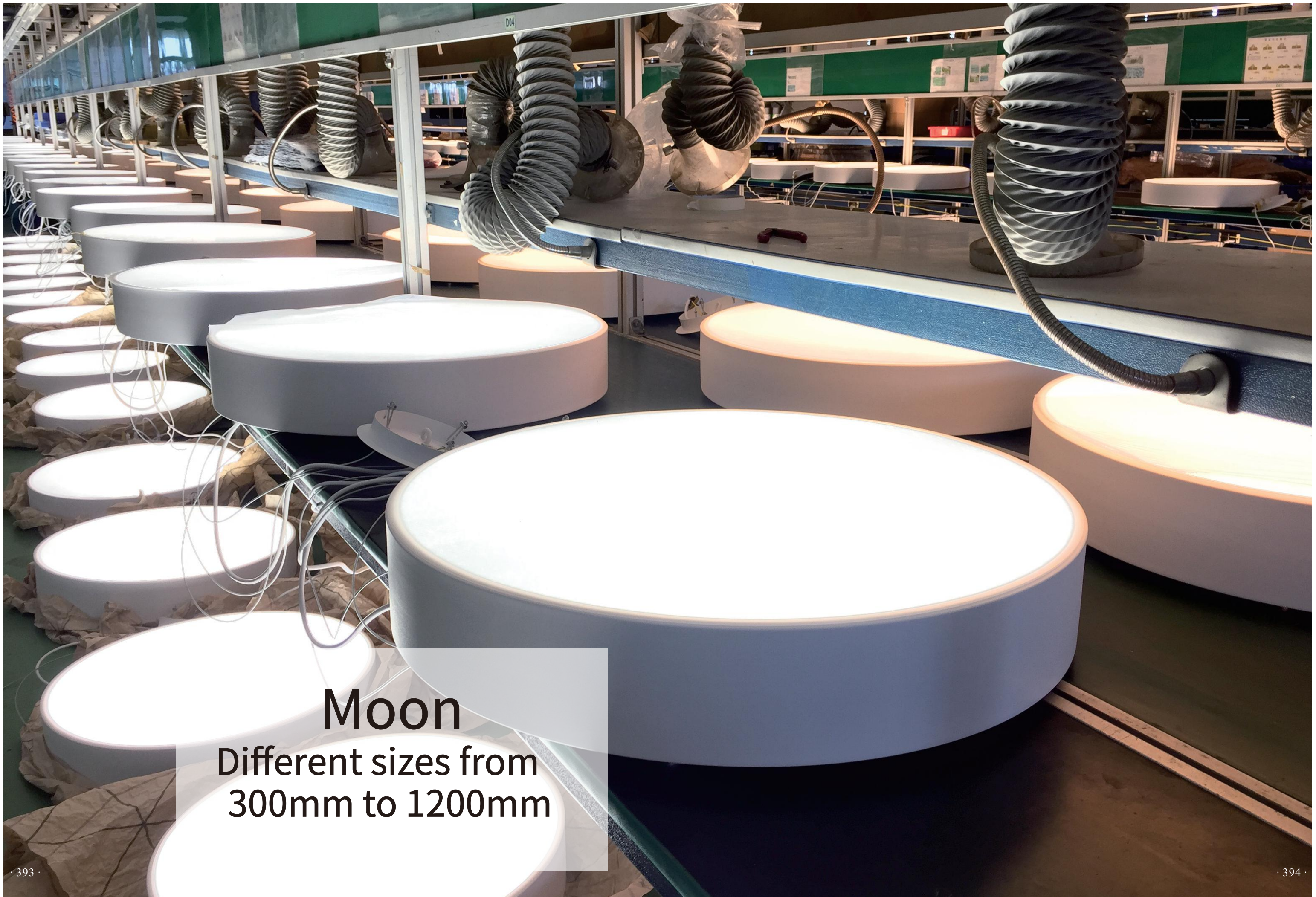

**Moon**  
Different sizes from  
300mm to 1200mm



# OFFICE LIGHTING

Lighting technology meets the precision of design. Visual comfort finds its most rational form, creating spectacular effects with the simplicity of pure geometry.

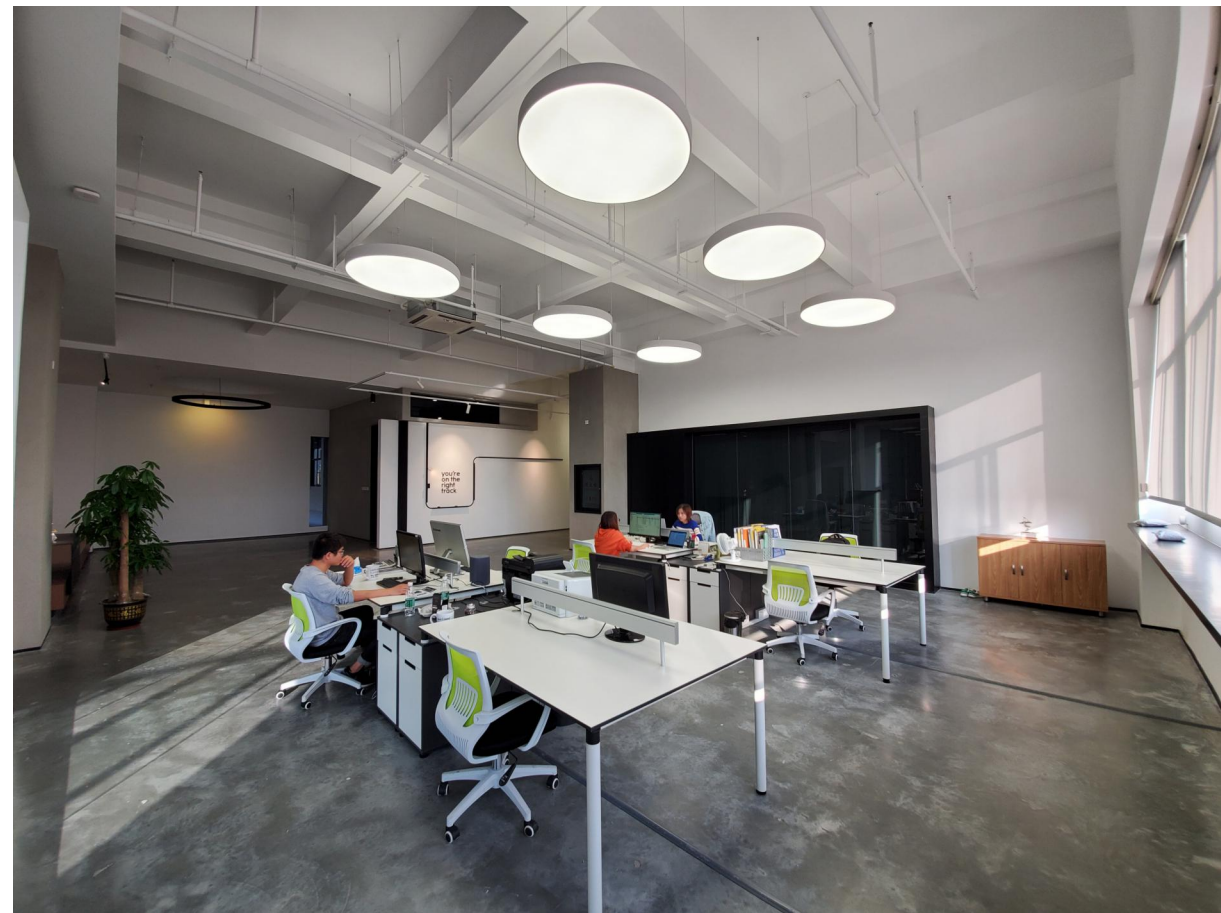

The MOON many different sizes allow great flexibility in the way the surface lamps are integrated into special concepts. In the suspended version of the luminaires, the ceiling canopies are modified in the same color as the lamp, thereby contributing to a consistent interior.

LED Type: SAMSUNG IP20 White color as standard Moon

Power	CRI	Beam Angle	Luminous Flux	CCT	Diffuser	Housing	Model Number
25W	>80	100°	1800lm	3000K	acrylic	white	MOON40-W30R
			1800lm	4000K	acrylic	black	MOON40-W40R
36W			2380lm	3000K	acrylic	black	MOON50-W30R
			2380lm	4000K	acrylic	black	MOON50-W40R
48W			3220lm	3000K	acrylic	white	MOON60-W30R
			3220lm	4000K	acrylic	black	MOON60-W40R
96W			6720lm	3000K	acrylic	white	MOON80-W30R
			6720lm	4000K	acrylic	black	MOON80-W40R
130W			9800lm	3000K	acrylic	white	MOON10-W30R
			9800lm	4000K	acrylic	black	MOON10-W40R
164W			10660lm	3000K	acrylic	white	MOON12-W30R
			10660lm	4000K	acrylic	black	MOON12-W40R

LED Type: SAMSUNG IP20 White color as standard Moon

Power	CRI	Beam Angle	Luminous Flux	CCT	Diffuser	Housing	Model Number
25W	>80	100°	1800lm	3000K	acrylic	white	MOON40-W30S
			1800lm	4000K	acrylic	black	MOON40-W40S
36W			2380lm	3000K	acrylic	black	MOON50-W30S
			2380lm	4000K	acrylic	black	MOON50-W40S
48W			3220lm	3000K	acrylic	white	MOON60-W30S
			3220lm	4000K	acrylic	black	MOON60-W40S
96W			6720lm	3000K	acrylic	white	MOON80-W30S
			6720lm	4000K	acrylic	black	MOON80-W40S
130W			9800lm	3000K	acrylic	white	MOON10-W30S
			9800lm	4000K	acrylic	black	MOON10-W40S
164W			10660lm	3000K	acrylic	white	MOON12-W30S
			10660lm	4000K	acrylic	black	MOON12-W40S

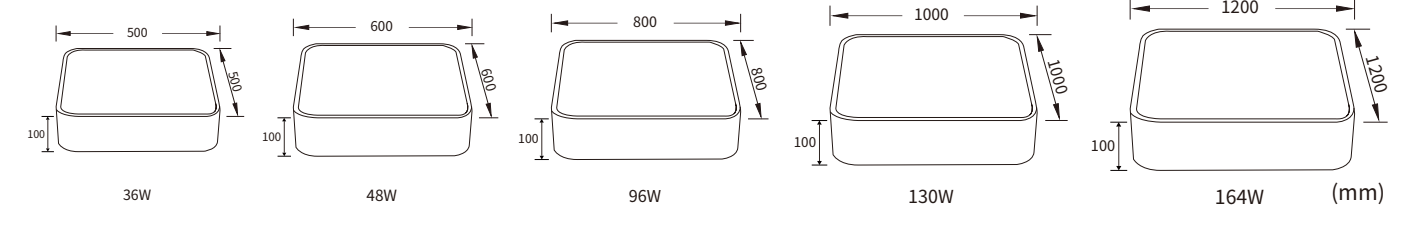
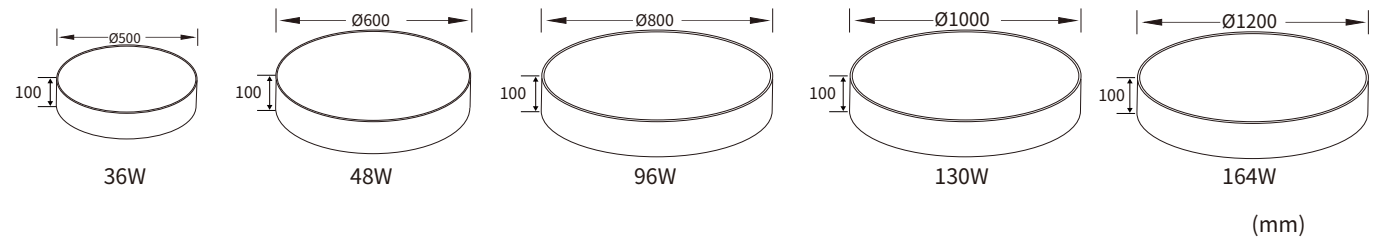

Accessory

suspended kit up & down (optional)

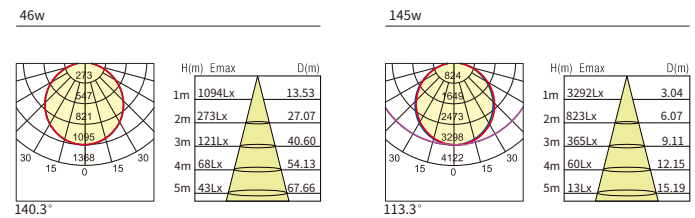

LED & Driver

SAMSUNG smd5730:  
 Power: 0.5W/LED  
 Voltage: 3-3.2V  
 SDCM<6  
 Driver:  
 Input Voltage:220-240VAC  
 Output Current:  
 580/800/1100mA  
 Output Voltage:  
 DC26-44V/40-55V/36-42V



600mm G.W.:4.98kgs  
 Packaging:65x65x16cm,1PCS/CTN  
 1200mm G.W.:16.87kgs  
 Packaging:125x125x16cm,1PCS/CTN



Accessory

suspended kit (optional)

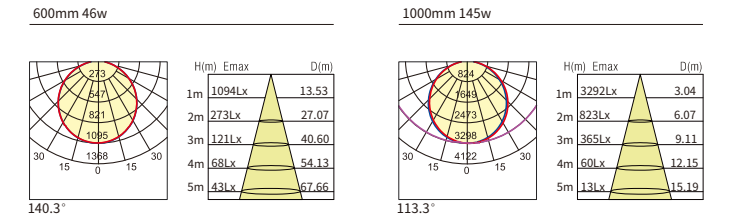

LED & Driver

SAMSUNG smd5730:  
 Power: 0.5W/LED  
 Voltage: 3-3.2V  
 SDCM<6  
 Driver:  
 Input Voltage:220-240VAC  
 Output Current:  
 580/800/1100mA  
 Output Voltage:  
 DC26-44V/40-55V/36-42V



600mm G.W.:4.98kgs  
 Packaging:65x65x16cm,1PCS/CTN  
 1200mm G.W.:16.87kgs  
 Packaging:125x125x16cm,1PCS/CTN





MOON slim and classic illumination that sets new standards.

The round, seamlessly welded surface lights makes a discreetly elegant impression but set unique accents in any space. In playing with various sizes and classic or unconventional arrangements, MOON becomes a formative architectural element.



LED Type SAMSUNG IP20  White color as standard **Moon**

Power	CRI	Beam Angle	Luminous Flux	CCT	Diffuser	Frame	Model Number
20W	>80	100°	1400lm	3000K	PC	white	MO6030-W30R
			1450lm	4000K	PC	black	MO6030-W40R
			1500lm	6000K	PC	white	MO6030-W60R
28W	>80	100°	1960lm	3000K	PC	black	MO6040-W30R
			2050lm	4000K	PC	white	MO6040-W40R
			2150lm	6000K	PC	black	MO6040-W60R
36W	>80	100°	2520lm	3000K	PC	white	MO6050-W30R
			2600lm	4000K	PC	black	MO6050-W40R
			2650lm	6000K	PC	white	MO6050-W60R
48W	>80	100°	3360lm	3000K	PC	black	MO6060-W30R
			3600lm	4000K	PC	white	MO6060-W40R
			3850lm	6000K	PC	black	MO6060-W60R

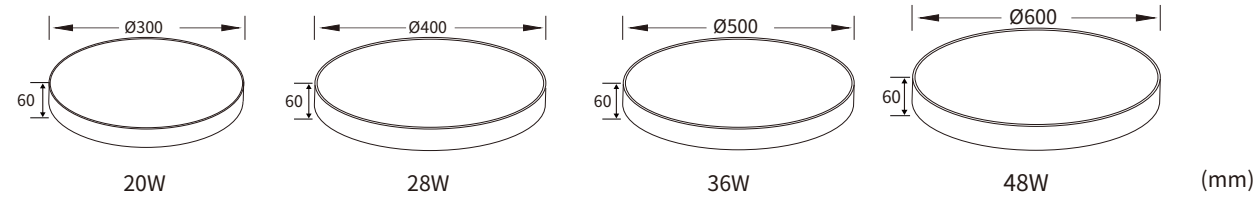

Accessory

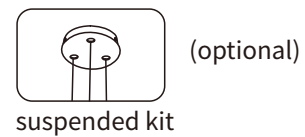

LED & Driver

SAMSUNG smd2835:  
Power: 1-1.5/LED  
Voltage: 3-3.2V  
SDCM<6  
Driver:  
Input Voltage:220-240VAC  
Output Current:  
580/800mA  
Output Voltage:  
DC26-44V/40-55V



300mm G.W.:1.46kgs  
Packaging:37x37x12cm,1PCS/CTN  
400mm G.W.:2.20kgs  
Packaging:47x47x12cm,1PCS/CTN  
500mm G.W.:3.60kgs  
Packaging:57x57x12cm,1PCS/CTN  
600mm G.W.:4.70kgs  
Packaging:67x67x12cm,1PCS/CTN

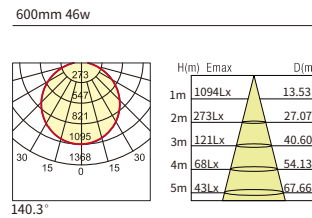

LED Type SAMSUNG IP20  White color as standard **Moon**

Power	CRI	Beam Angle	Luminous Flux	CCT	Diffuser	Frame	Model Number
24W	>80	100°	1680lm	3000K	PC	white	MO6040-W30S
			1700lm	4000K	PC	black	MO6040-W40S
			1920lm	6000K	PC	white	MO6040-W60S
36W	>80	100°	2520lm	3000K	PC	black	MO6050-W30S
			2600lm	4000K	PC	white	MO6050-W40S
			2880lm	6000K	PC	black	MO6050-W60S
48W	>80	100°	3360lm	3000K	PC	white	MO6060-W30S
			3600lm	4000K	PC	black	MO6060-W40S
			3840lm	6000K	PC	white	MO6060-W60S
72W	>80	100°	4680lm	3000K	PC	black	MO6090-W30S
			5040lm	4000K	PC	white	MO6090-W40S
			5400lm	6000K	PC	black	MO6090-W60S

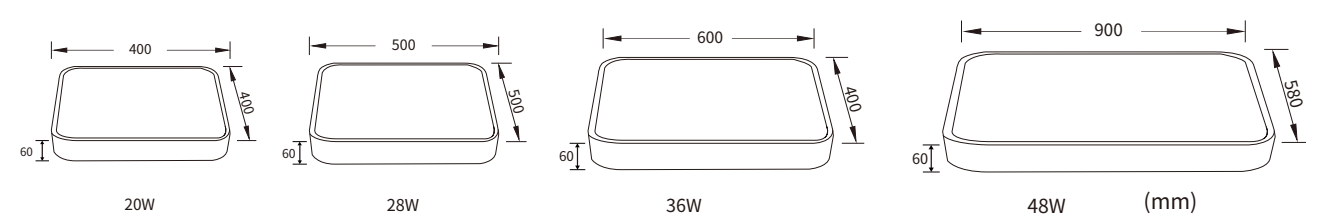

Accessory

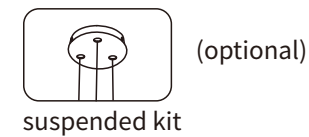

LED & Driver

SAMSUNG smd2835:  
Power: 1-1.5/LED  
Voltage: 3-3.2V  
SDCM<6  
Driver:  
Input Voltage:220-240VAC  
Output Current:  
580/800mA  
Output Voltage:  
DC26-44V/40-55V



400mm G.W.:2.20kgs  
Packaging:47x47x12cm,1PCS/CTN  
500mm G.W.:2.80kgs  
Packaging:57x57x12cm,1PCS/CTN  
600mm G.W.:3.30kgs  
Packaging:67x47x12cm,1PCS/CTN  
900mm G.W.:6.30kgs  
Packaging:97x65x12cm,1PCS/CTN

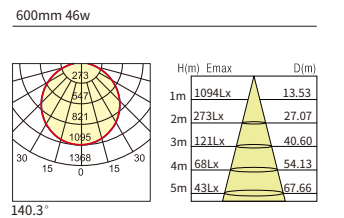



LED  
**COLORFULLIGHT**  
round shape it literally  
invites you to play with colour.





# H10

## Installation Method

---



LED Type: Osram IP20 ● Black as standard **HIO**

Power	CRI	BeamAngle	Luminous Flux	CCT	Refractive screen	Frame	Model Number
35W	>90	25°	2800lm	2700K	white	black	HIO30-B2725
			2800lm	3000K	white	black	HIO30-B3025
			2800lm	4000K	white	black	HIO30-B4025
		40°	2800lm	2700K	white	black	HIO30-B2740
			2800lm	3000K	white	black	HIO30-B3040
			2800lm	4000K	white	black	HIO30-B4040

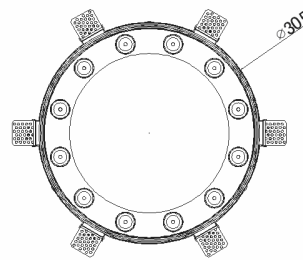
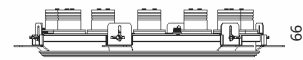

(mm)

LED & Driver

Osram COB  
 Power: 2-3W/LED  
 Voltage: 36V  
 SDCM<6  
 Lifud Driver:  
 Input voltage: 100-240VAC  
 /220-240V/110-130V  
 Output current: 350mA  
 Output voltage: DC12-42V

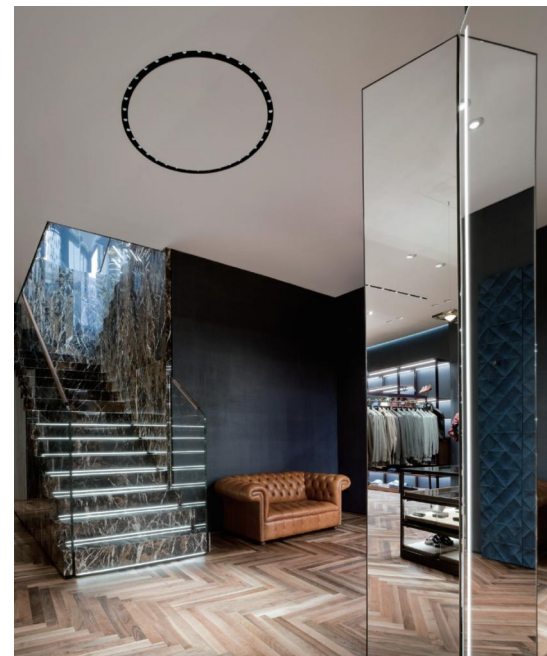

LED Type: Osram IP20 ● Black as standard **HIO**

Power	CRI	BeamAngle	Luminous Flux	CCT	Refractive screen	Frame	Model Number
70W	>90	25°	5600lm	2700K	white	black	HIO70-B2725
			5600lm	3000K	white	black	HIO70-B3025
			5600lm	4000K	white	black	HIO70-B4025
		40°	5600lm	2700K	white	black	HIO70-B2740
			5600lm	3000K	white	black	HIO70-B3040
			5600lm	4000K	white	black	HIO70-B4040

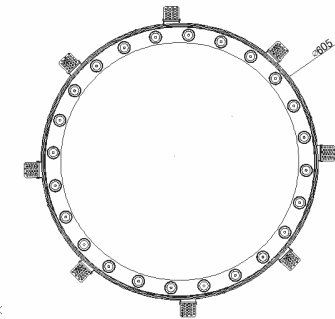

(mm)

LED & Driver

Osram COB  
 Power: 2-3W/LED  
 Voltage: 36V  
 SDCM<6  
 MEANWELL Driver:  
 Input voltage: 100-240VAC  
 /220-240V/110-130V  
 Output current: 500mA  
 Output voltage: DC12-42V





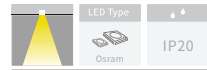

● Black as standard

HIO

Power	CRI	Beam Angle	Luminous Flux	CCT	Refractive screen	Frame	Model Number
105W	>90	25°	8000lm	2700K	white	black	HIO105-B2725
			8000lm	3000K	white	black	HIO105-B3025
			8000lm	4000K	white	black	HIO105-B4025
		40°	8000lm	2700K	white	black	HIO105-B2740
			8000lm	3000K	white	black	HIO105-B3040
			8000lm	4000K	white	black	HIO105-B4040

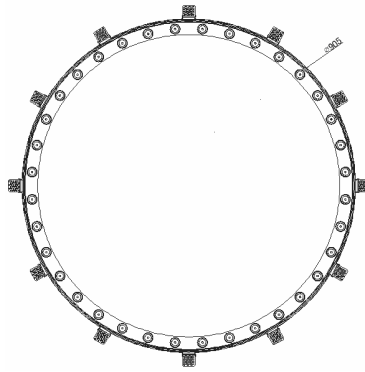

(mm)

LED & Driver

Osram COB  
 Power: 2-3W/LED  
 Voltage: 36V  
 SDCM<6  
 Lifud Driver:  
 Input voltage:100-240VAC  
 /220-240V/110-130V  
 Output current:700mA  
 Output voltage:DC12-42V









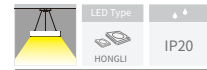

○ White color as standard

## Loop

Power	CRI	Beam Angle	Luminous Flux	CCT	Material	Housing	Model Number
25W	>80		1500lm	3000K	aluminum+PS	white	LOOP450-W30
			1550lm	4000K	aluminum+PS	black	LOOP450-B40
35W			2100lm	3000K	aluminum+PS	white	LOOP600-W30
			2150lm	4000K	aluminum+PS	black	LOOP600-B40
55W			3300lm	3000K	aluminum+PS	white	LOOP950-W30
			3350lm	4000K	aluminum+PS	black	LOOP950-B40
75W			4500lm	3000K	aluminum+PS	white	LOOP1200-W30
			4550lm	4000K	aluminum+PS	black	LOOP1200-B40

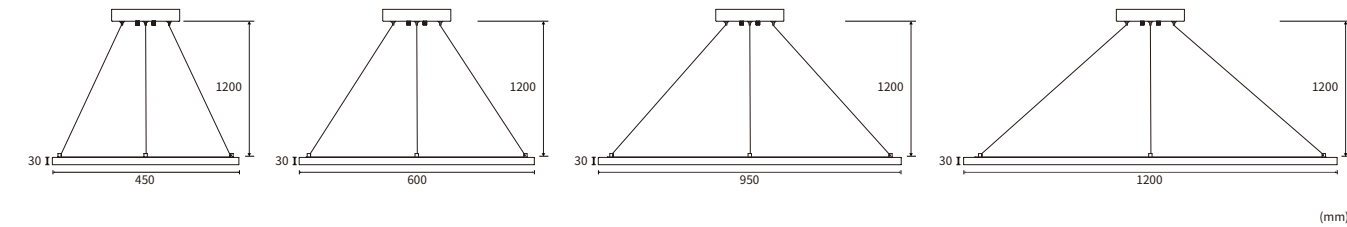

### LED & Driver

Hongli smd2835:  
Power: 0.2W/LED  
Voltage: 24V  
SDCM<6  
Driver:  
Input Voltage:  
MEANWELL 220-240VAC

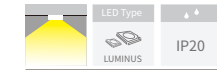

○ White color as standard

## Loop Spot

Power	CRI	Beam Angle	Luminous Flux	CCT	Material	Housing	Model Number
3x5W	>90	15°	1050lm	3000K	aluminum	black	LOOPS7015-B3015
			1125lm	4000K	aluminum	black	LOOPS7015-B4015
			1200lm	5000K	aluminum	black	LOOPS7015-B5015
			1050lm	3000K	aluminum	black	LOOPS7015-B3024
			1125lm	4000K	aluminum	black	LOOPS7015-B4024
			1200lm	5000K	aluminum	black	LOOPS7015-B5024
		24°	1050lm	3000K	aluminum	black	LOOPS7015-B3036
			1125lm	4000K	aluminum	black	LOOPS7015-B4036
			1200lm	5000K	aluminum	black	LOOPS7015-B5036
			1050lm	3000K	aluminum	black	LOOPS7015-B3060
			1125lm	4000K	aluminum	black	LOOPS7015-B4060
			1200lm	5000K	aluminum	black	LOOPS7015-B5060

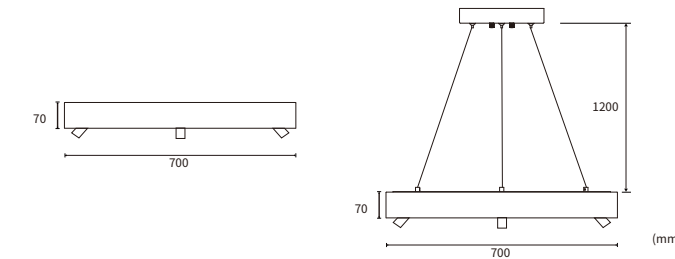

### LED & Driver

LUMINUS COB:  
Power: 5W/LED  
Voltage: 36V  
SDCM<6  
Driver:  
Input Voltage:KEGU185-265VAC



45W G.W.:2.60kgs  
Packaging:76x14x77cm,1PCS/CTN



LED Type: LUMINUS IP20  White color as standard **Loop Spot**

Power	CRI	Beam Angle	Luminous Flux	CCT	Material	Housing	Model Number
6x5W	>90	15°	2100lm	3000K	aluminum	black	LOOPS1230-B3015
			2250lm	4000K	aluminum	black	LOOPS1230-B4015
			2400lm	5000K	aluminum	black	LOOPS1230-B5015
		24°	2100lm	3000K	aluminum	black	LOOPS1230-B3024
			2250lm	4000K	aluminum	black	LOOPS1230-B4024
			2400lm	5000K	aluminum	black	LOOPS1230-B5024
		36°	2100lm	3000K	aluminum	black	LOOPS1230-B3036
			2250lm	4000K	aluminum	black	LOOPS1230-B4036
			2400lm	5000K	aluminum	black	LOOPS1230-B5036

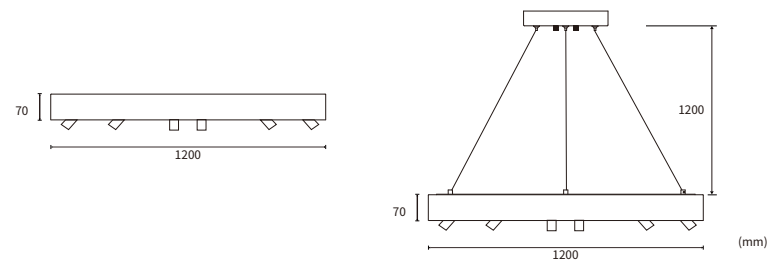

**LED & Driver**

LUMINUS COB:  
 Power: 5W/LED  
 Voltage: 36V  
 SDCM<6  
 Driver:  
 Input Voltage:KEGU 185-265VAC



45W G.W.:2.60kgs  
 Packaging:126x14x127cm,1PCS/CTN



LED Type: LUMINUS IP20  White color as standard **Loop Spot**

Power	CRI	Beam Angle	Luminous Flux	CCT	Material	Housing	Model Number
10x5W	>90	15°	3500lm	3000K	aluminum	black	LOOPS1250-B3015
			3750lm	4000K	aluminum	black	LOOPS1250-B4015
			4000lm	5000K	aluminum	black	LOOPS1250-B5015
		24°	3500lm	3000K	aluminum	black	LOOPS1250-B3024
			3750lm	4000K	aluminum	black	LOOPS1250-B4024
			4000lm	5000K	aluminum	black	LOOPS1250-B5024
		36°	3500lm	3000K	aluminum	black	LOOPS1250-B3036
			3750lm	4000K	aluminum	black	LOOPS1250-B4036
			4000lm	5000K	aluminum	black	LOOPS1250-B5036

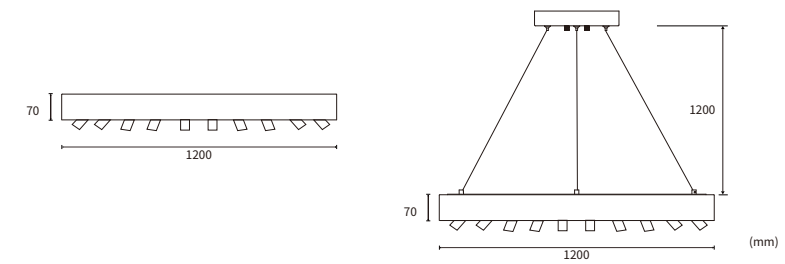

**LED & Driver**

LUMINUS COB:  
 Power: 5W/LED  
 Voltage: 36V  
 SDCM<6  
 Driver:  
 Input Voltage:KEGU 185-265VAC



45W G.W.:2.60kgs  
 Packaging:126x14x127cm,1PCS/CTN





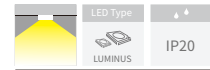

○ White color as standard

## Loop Spot

Power	CRI	Beam Angle	Luminous Flux	CCT	Material	Housing	Model Number
10x5W	>90	15°	3500lm	3000K	aluminum	black	LOOPS1850-B3015
			3750lm	4000K	aluminum	black	LOOPS1850-B4015
			4000lm	5000K	aluminum	black	LOOPS1850-B5015
		24°	3500lm	3000K	aluminum	black	LOOPS1850-B3024
			3750lm	4000K	aluminum	black	LOOPS1850-B4024
			4000lm	5000K	aluminum	black	LOOPS1850-B5024
		36°	3500lm	3000K	aluminum	black	LOOPS1850-B3036
			3750lm	4000K	aluminum	black	LOOPS1850-B4036
			4000lm	5000K	aluminum	black	LOOPS1850-B5036

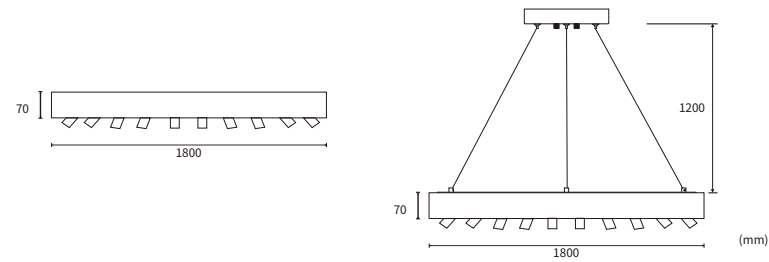

### LED & Driver

LUMINUS COB:  
Power: 5W/LED  
Voltage: 36V  
SDCM<6  
Driver:  
Input Voltage:KEGU 185-265VAC



45W G.W.:3.60kgs  
Packaging:186x14x127cm,1PCS/CTN

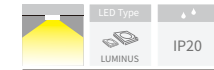

○ White color as standard

## Loop Spot

Power	CRI	Beam Angle	Luminous Flux	CCT	Material	Housing	Model Number
10x5W	>90	15°	3500lm	3000K	aluminum	black	LOOPS2050-B3015
			3750lm	4000K	aluminum	black	LOOPS2050-B4015
			4000lm	5000K	aluminum	black	LOOPS2050-B5015
		24°	3500lm	3000K	aluminum	black	LOOPS2050-B3024
			3750lm	4000K	aluminum	black	LOOPS2050-B4024
			4000lm	5000K	aluminum	black	LOOPS2050-B5024
		36°	3500lm	3000K	aluminum	black	LOOPS2050-B3036
			3750lm	4000K	aluminum	black	LOOPS2050-B4036
			4000lm	5000K	aluminum	black	LOOPS2050-B5036

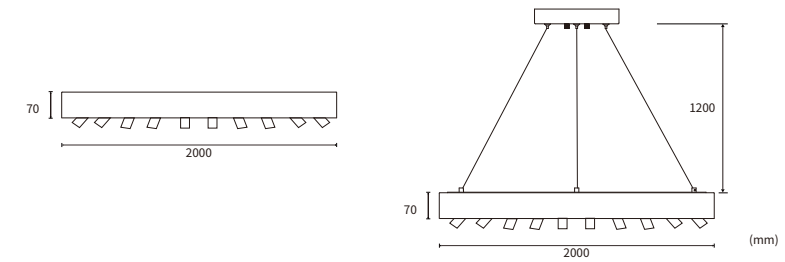

### LED & Driver

LUMINUS COB:  
Power: 5W/LED  
Voltage: 36V  
SDCM<6  
Driver:  
Input Voltage:KEGU 185-265VAC



45W G.W.:4.20kgs  
Packaging:206x14x127cm,1PCS/CTN





○ White color as standard

### Circle

Power	CRI	Beam Angle	Luminous Flux	CCT	Housing	Model Number
40W	>80	100°	2600lm	3000K	black	CIR7040-B30
			2800lm	4000K	white	CIR7040-W40
			3000lm	5000K	white	CIR7040-W50

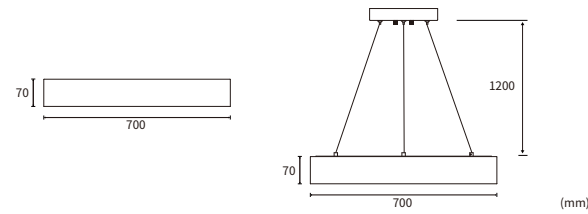

#### LED & Driver

Hongli smd2835:  
Power: 0.2W/LED  
Voltage: 24V  
SDCM<6  
Driver:  
Input Voltage:  
MEANWELL 185-265VAC



G.W.:2.60kgs  
Packaging:76x14x77cm,1PCS/CTN

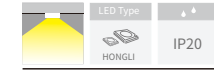

○ White color as standard

### Circle

Power	CRI	Beam Angle	Luminous Flux	CCT	Housing	Model Number
80W	>80	100°	5200lm	3000K	black	CIR12080-B30
			5600lm	4000K	white	CIR12080-W40
			6000lm	5000K	white	CIR12080-W50

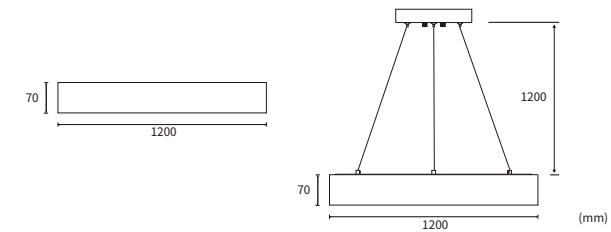

#### LED & Driver

Hongli smd2835:  
Power: 0.2W/LED  
Voltage: 24V  
SDCM<6  
Driver:  
Input Voltage:  
MEANWELL 185-265VAC



G.W.:6.30kgs  
Packaging:126x14x127cm,1PCS/CTN



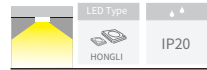

○ White color as standard

### Circle

Power	CRI	Beam Angle	Luminous Flux	CCT	Housing	Model Number
120W	>80	100°	7800lm	3000K	black	CIR170120-B30
			8400lm	4000K	white	CIR170120-W40
			9000lm	5000K	white	CIR170120-W50

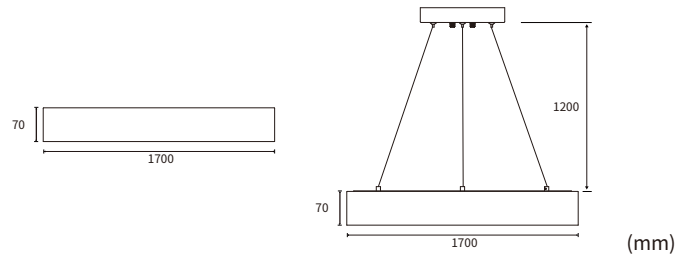

#### LED & Driver

Hongli smd2835:  
 Power: 0.2W/LED  
 Voltage: 24V  
 SDCM<6  
 Driver:  
 Input Voltage:  
 MEANWELL 185-265VAC



G.W.:8.60kgs  
 Packaging:176x14x177cm,1PCS/CTN

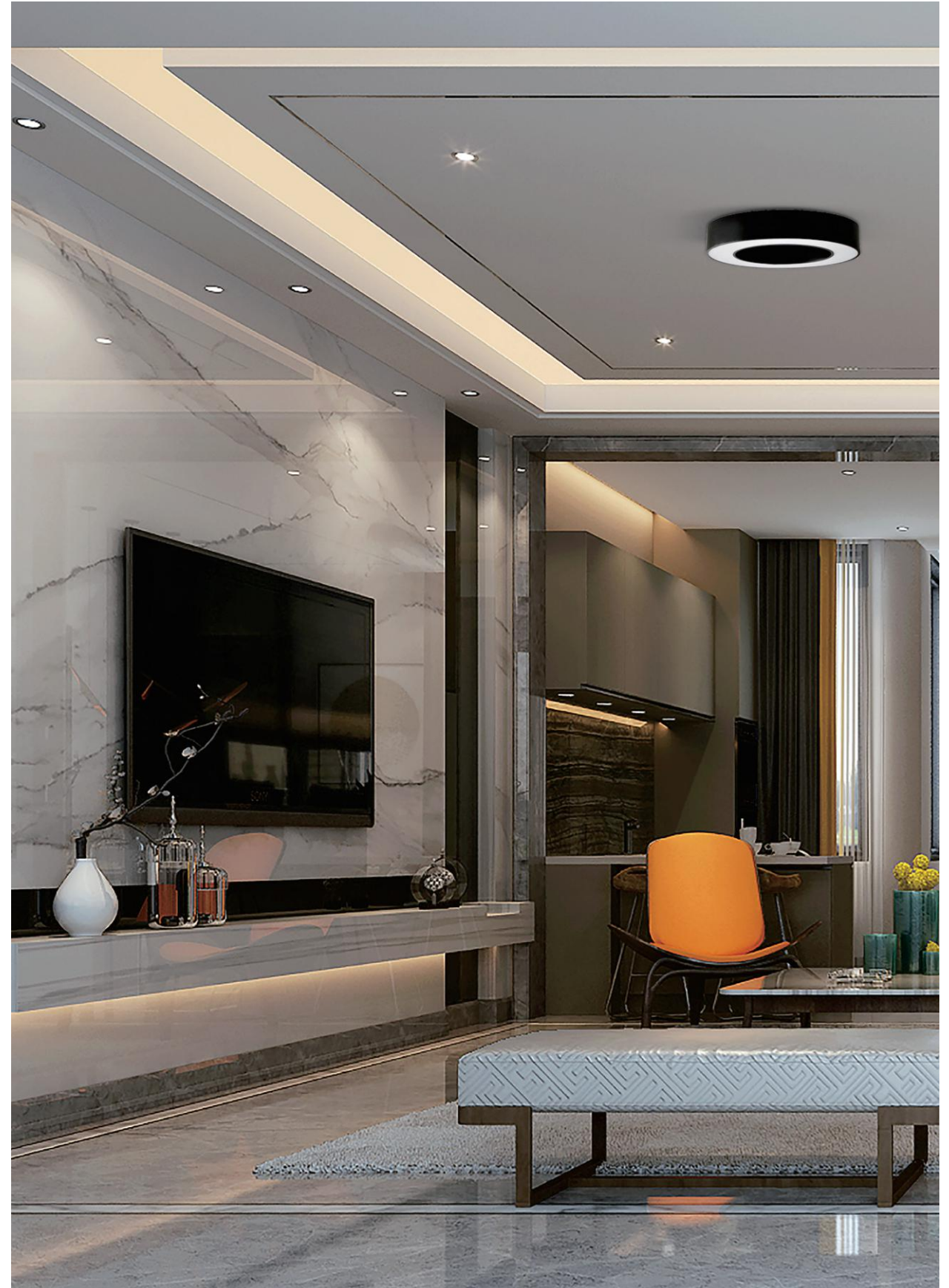



LED Type SANAN IP20  White color as standard **Light white**

Power	CRI	Beam Angle	Luminous Flux	CCT	Material	Housing	Model Number
30W	>80	100°	2000lm	3000K	Iron+Alu+PS	white	LIW30-W30
			2050lm	4000K	Iron+Alu+PS	light blue	LIW30-B40
			2100lm	6000K	Iron+Alu+PS	grey	LIW30-G60
40W	>80	100°	2500lm	3000K	Iron+Alu+PS	white	LIW40-W30
			2550lm	4000K	Iron+Alu+PS	light blue	LIW40-B40
			2600lm	6000K	Iron+Alu+PS	grey	LIW40-G60
80W	>80	100°	4000lm	3000K	Iron+Alu+PS	white	LIW80-W30
			4050lm	4000K	Iron+Alu+PS	light blue	LIW80-B40
			4100lm	6000K	Iron+Alu+PS	grey	LIW80-G60

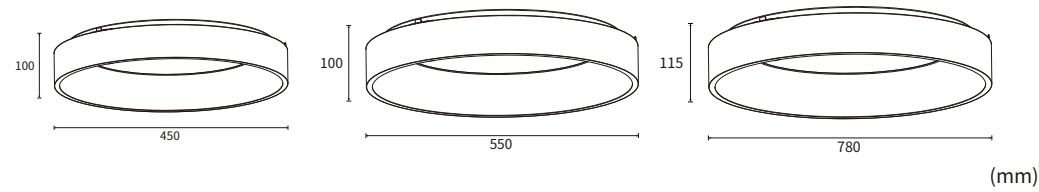

**LED & Driver**  
 Sanan smd2835:  
 Power: 1W/LED  
 Voltage: 3V  
 SDCM<6  
 Driver:  
 Input Voltage:185-265VAC

40W G.W.:2.60kgs  
 Packaging:55x12x55cm,1PCS/CTN  
 50W G.W.:3.30kgs  
 Packaging:63x12x63cm,1PCS/CTN

CE, IZ, SAA, CB, [Square Icon], [House Icon]

LED Type SANAN IP20  White color as standard **Light ring**

Power	CRI	Beam Angle	Luminous Flux	CCT	Material	Housing	Model Number
30W	>80	100°	2000lm	3000K	Iron+Alu+PS	white	LIR30-W30
			2050lm	4000K	Iron+Alu+PS	light blue	LIR30-B40
			2100lm	6000K	Iron+Alu+PS	grey	LIR30-G60
40W	>80	100°	2500lm	3000K	Iron+Alu+PS	white	LIR40-W30
			2550lm	4000K	Iron+Alu+PS	light blue	LIR40-B40
			2600lm	6000K	Iron+Alu+PS	grey	LIR40-G60
80W	>80	100°	4000lm	3000K	Iron+Alu+PS	white	LIR80-W30
			4050lm	4000K	Iron+Alu+PS	light blue	LIR80-B40
			4100lm	6000K	Iron+Alu+PS	grey	LIR80-G60

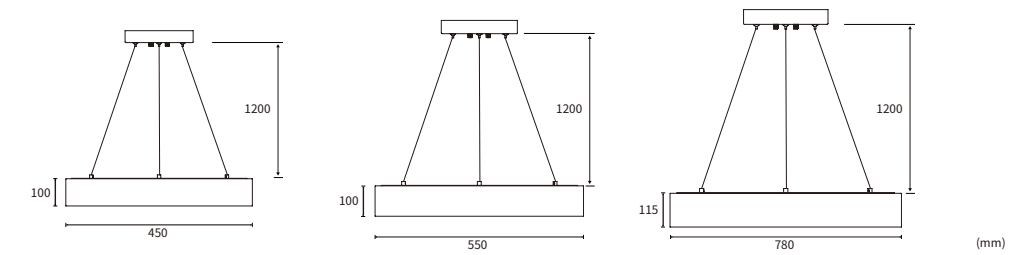
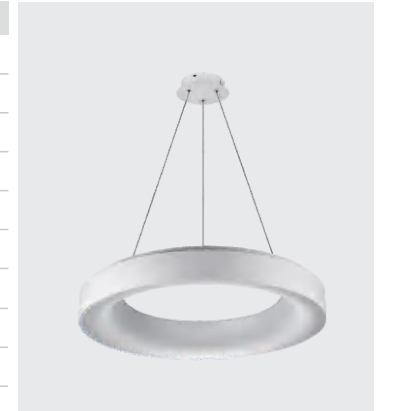

**LED & Driver**  
 Sanan smd2835:  
 Power: 1W/LED  
 Voltage: 3V  
 SDCM<6  
 Driver:  
 Input Voltage:185-265VAC

40W G.W.:3.10kgs  
 Packaging:55x12x55cm,1PCS/CTN  
 50W G.W.:3.80kgs  
 Packaging:63x12x63cm,1PCS/CTN

CE, IZ, SAA, CB, [Square Icon], [House Icon]